

1 2 3 4 5

A  
B  
C  
D  
E  
F

For [E,EB,EF,E P] areas.

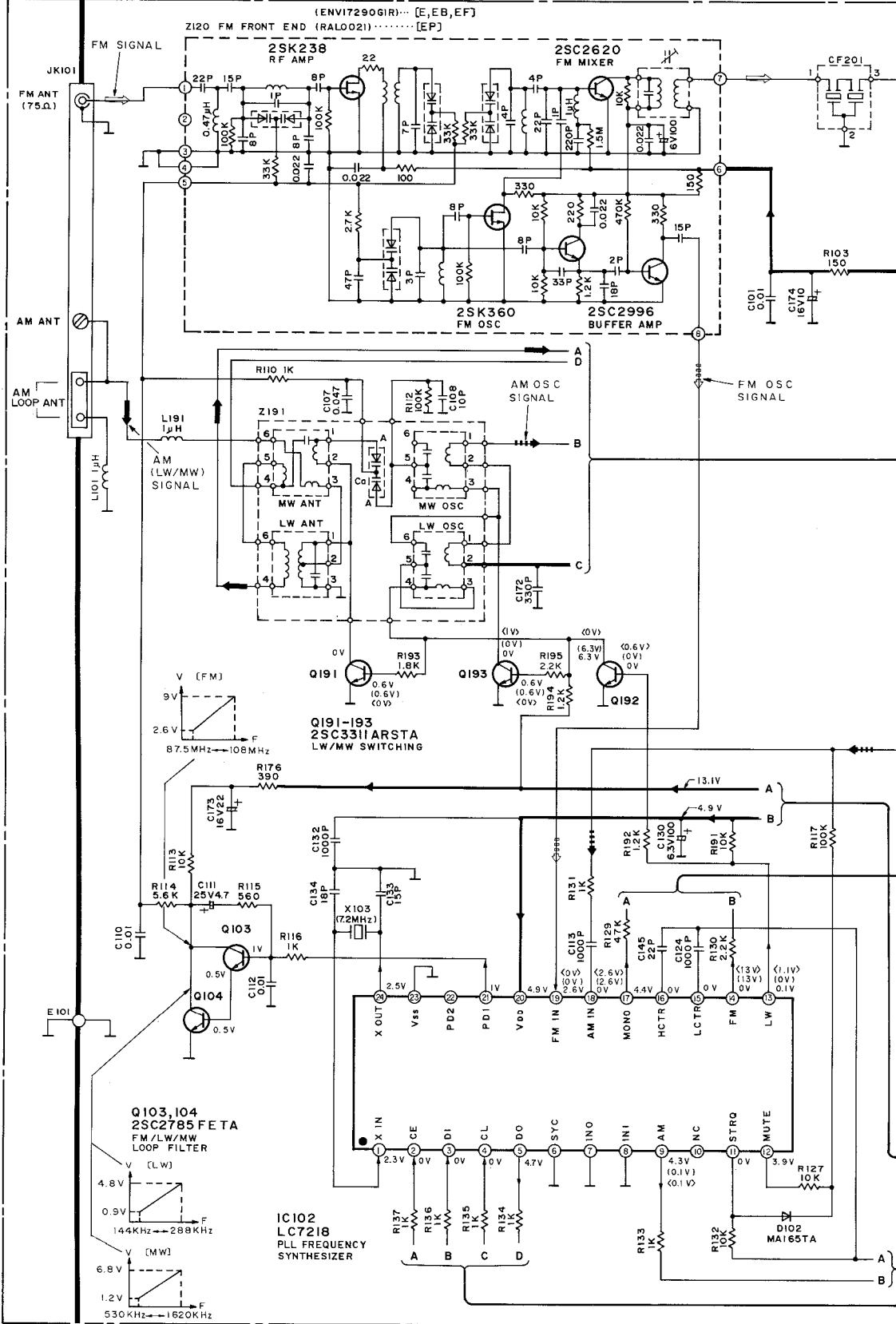

A MAIN CIRCU

For [EG,EI,GC,GN] areas.

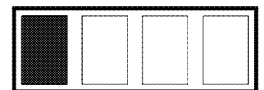
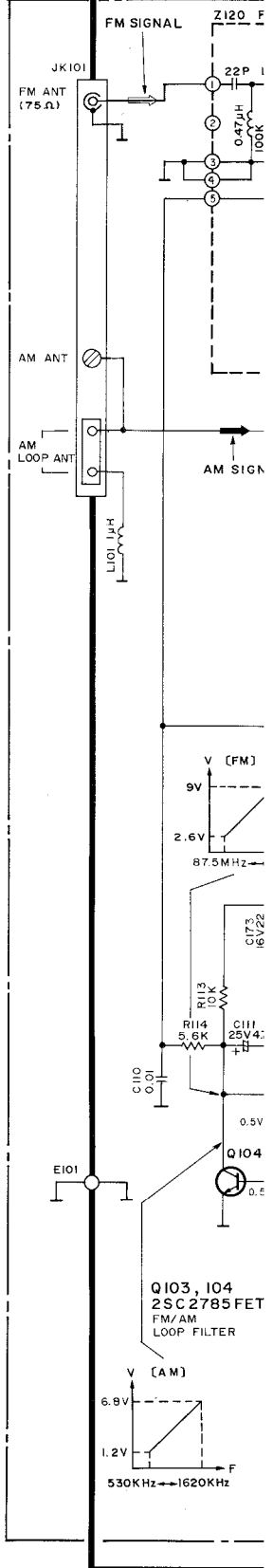

CIRCUIT (FM FRONT END/PLL/FM-AM IF AMP-DET-MPX/CONTROL/POWER SUPPLY/MUTING)

GC,GN]areas.

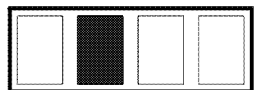
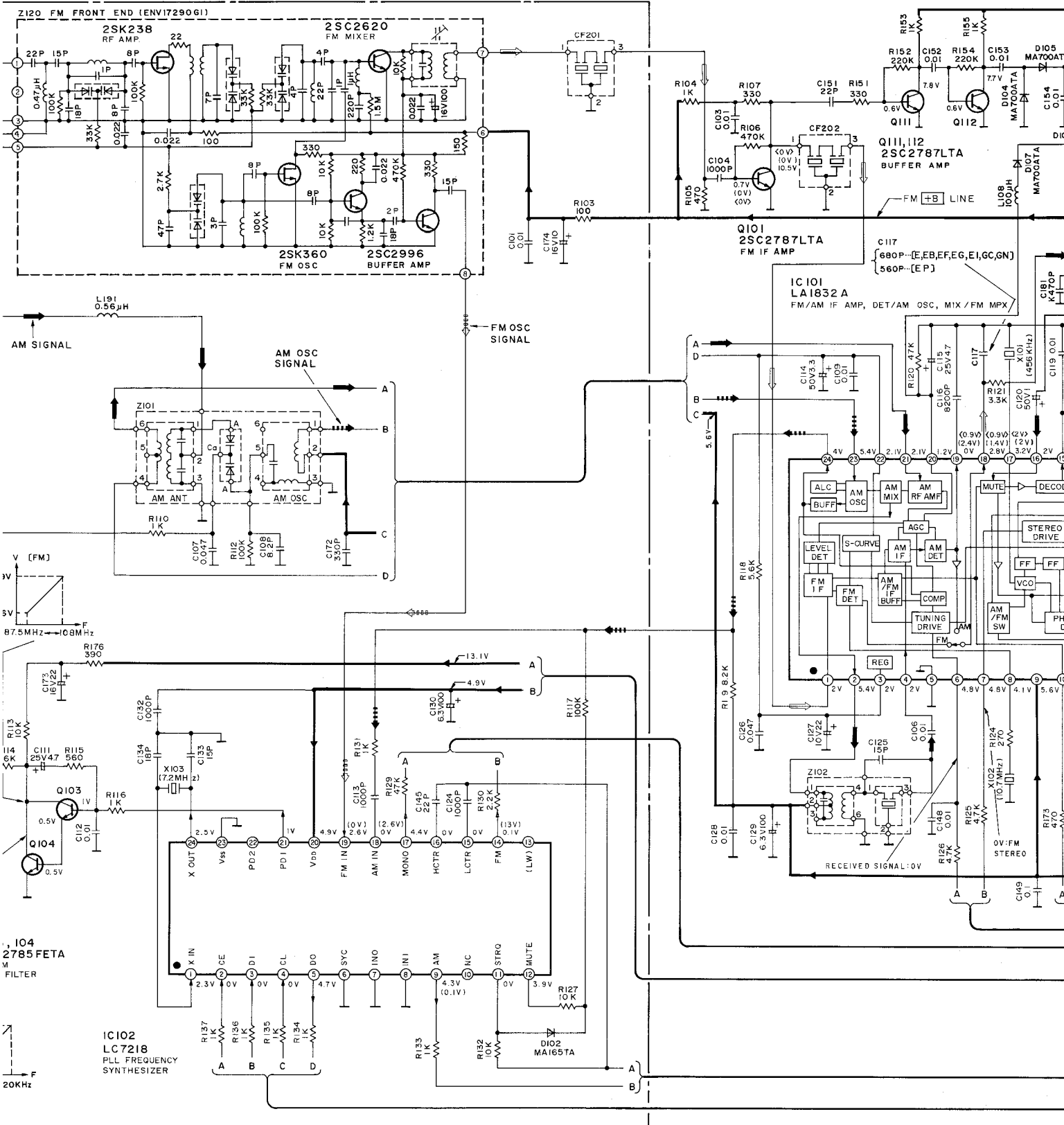

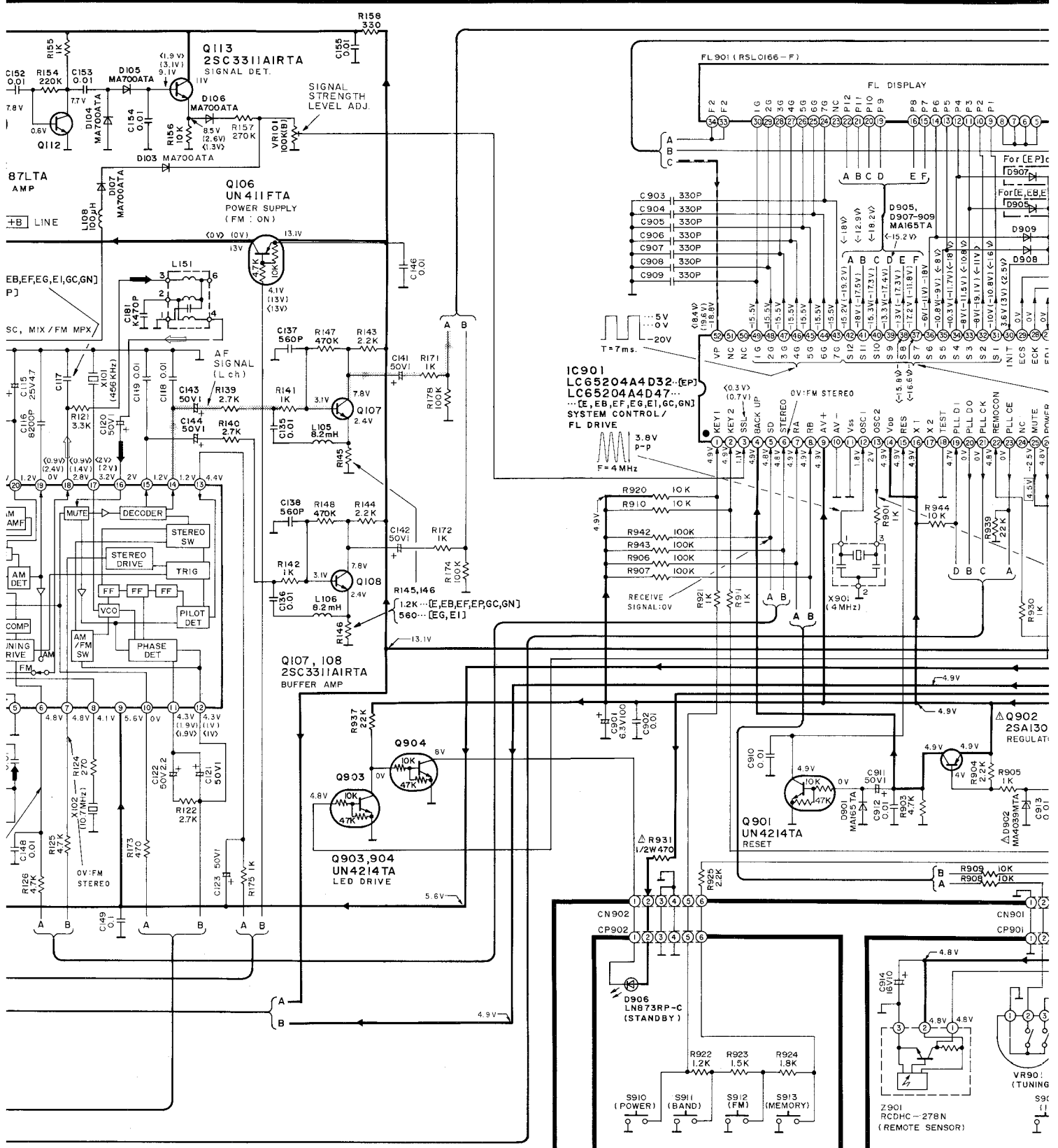

**B** POWER SWITCH CIRCUIT

**C** OPERATION CIRCUIT

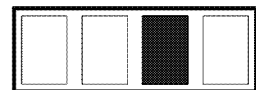

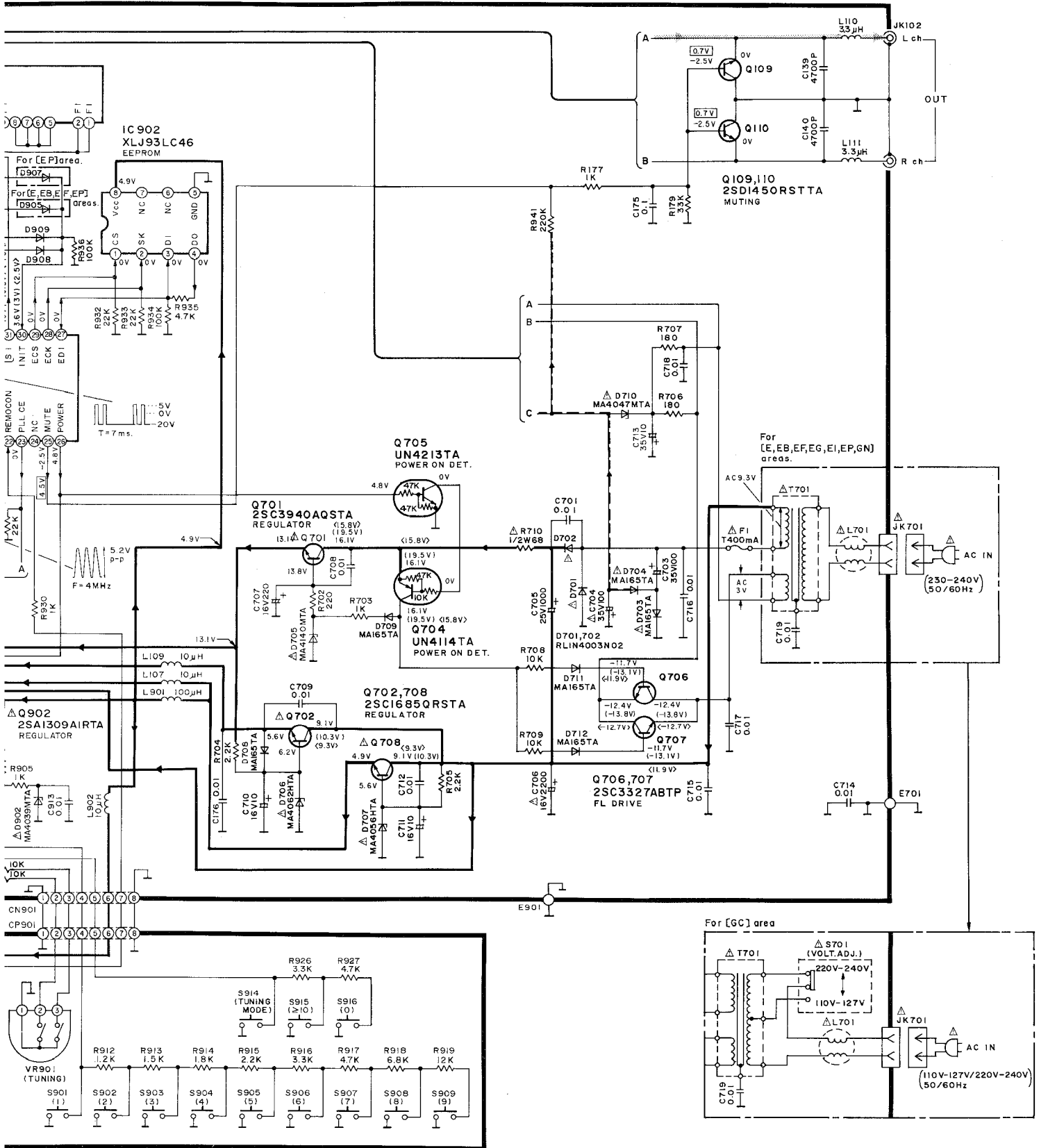

CIRCUIT

