

UNI-AND BIDIRECTIONAL TRANSIENT VOLTAGE SUPPRESSORS

- HIGH SURGE CAPABILITY :
400 W / 1 ms EXPO
- VERY FAST CLAMPING TIME :
1 ps FOR UNIDIRECTIONAL TYPES
5 ns FOR BIDIRECTIONAL TYPES
- LARGE VOLTAGE RANGE :
5.5 V → 188 V
- ORDER CODE :
TYPE NUMBER FOR UNIDIRECTIONAL
TYPES, TYPE NUMBER + SUFFIX C FOR
BIDIRECTIONAL TYPES

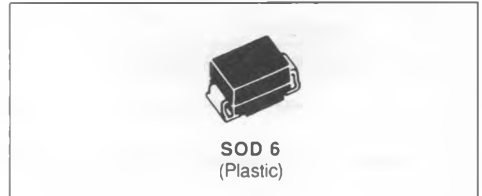

DESCRIPTION

Transient voltage suppressor diodes especially useful in protecting integrated circuits, MOS, hybrids and other voltage-sensitive semiconductors and components.

SURFACE MOUNT TRANSIL FEATURES

- A PERFECT PICK AND PLACE BEHAVIOUR
- AN EXCELLENT ON BOARD STABILITY
- A FULL COMPATIBILITY WITH BOTH GLUING AND PASTE SOLDERING TECHNOLOGIES
- BODY MARKED WITH TYPE CODE AND LOGO
- STANDARD PACKAGING : 12 mm TAPE (EIA STD. RS481)
- TINNED COPPER LEADS
- HIGH TEMPERATURE RESISTANT RESIN

ABSOLUTE RATINGS (limiting values)

Symbol	Parameter	Value	Unit
P_p	Peak Pulse Power for 1 ms Exponential Pulse	T_j Initial = 25 °C See note 1	400 W
P	Power Dissipation on Infinite Heatsink	$T_{amb} = 25$ °C	1.2 W
I_{FSM}	Non Repetitive Surge Peak Forward Current for Unidirectional Types	T_j Initial = 25 °C $t = 10$ ms	50 A
T_{stg} T_j	Storage and Operating Junction Temperature Range	- 65 to 175 150	°C °C
T_L	Maximum Lead Temperature for Soldering During 10 s	260	°C

THERMAL RESISTANCE

Symbol	Parameter	Value	Unit
$R_{th(j-l)}$	Junction-leads	20	°C/W

Note : 1. For surges upper than the maximum values, the diode will present a short-circuit anode-cathode.

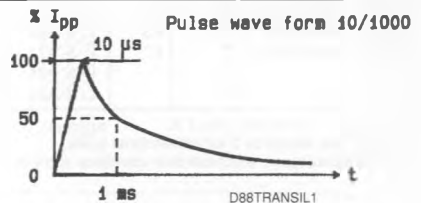

ELECTRICAL CHARACTERISTICS (T_j = 25 °C)

Symbol	Parameter	Value	
V _{RM}	Stand-off Voltage	See tables	
V _(BR)	Breakdown Voltage		
V _(CL)	Clamping Voltage		
I _{pp}	Peak Pulse Current		
α _T	Temperature Coefficient of V _(BR)		
C	Capacitance		
t _{clamping}	Clamping Time (0 volt to V _(BR))	Unidirectional Types	1 ps max.
		Bidirectional Types	5 ns max.

Types		Marking		I _{RM} @ V _{RM} max.		V _(BR) * @ I _R			V _(CL) @ I _{pp} max.		V _(CL) @ I _{pp} max.		α _T max.	C** typ. V _R =0 f=1MHz	
Unidirectional	Bidirectional	Unidirectional	Bidirectional	(μA)	(V)	min.	nom.	max.	(mA)	(V)	(A)	(V)	(A)	(10 ⁻⁴ /°C)	(pF)
										1ms expo	8-20μs expo				
SM4T6V8	SM4T6V8C	QD	VD	1000	5.5	6.12	6.8	7.48	10	10.8	37	14	164	5.7	3500
SM4T6V8A	SM4T6V8CA	QE	VE	1000	5.8	6.45	6.8	7.14	10	10.5	38	13.4	174	5.7	3500
SM4T7V5	SM4T7V5C	QF	VF	500	6.05	6.75	7.5	8.25	10	11.7	34	15.2	151	6.1	3100
SM4T7V5A	SM4T7V5CA	QG	VG	500	6.4	7.13	7.5	7.88	10	11.3	35.4	14.5	160	6.1	3100
SM4T10	SM4T10C	QN	VN	10	8.1	9	10	11	1	15	27	19.5	246	7.3	2000
SM4T10A	SM4T10CA	QP	VP	10	8.55	9.5	10	10.5	1	14.5	27.6	18.6	258	7.3	2000
SM4T12	SM4T12C	QS	VS	5	9.72	10.8	12	13.2	1	17.3	23.1	22.7	211	7.8	1550
SM4T12A	SM4T12CA	QT	VT	5	10.2	11.4	12	12.6	1	16.7	24	21.7	221	7.8	1550
SM4T15	SM4T15C	QW	VW	5	12.1	13.5	15	16.5	1	22	18.2	28.4	169	8.4	1200
SM4T15A	SM4T15CA	QX	VX	5	12.8	14.3	15	15.8	1	21.2	19	27.2	176	8.4	1200
SM4T18	SM4T18C	RD	UD	5	14.5	16.2	18	19.8	1	26.5	15.1	34	141	8.8	975
SM4T18A	SM4T18CA	RE	UE	5	15.3	17.1	18	18.9	1	25.2	16	32.5	148	8.8	975
SM4T22	SM4T22C	RH	UH	5	17.8	19.8	22	24.2	1	31.9	12.5	41.2	116	9.2	800
SM4T22A	SM4T22CA	RK	UK	5	18.8	20.9	22	23.1	1	30.6	13	39.3	122	9.2	800
SM4T24	SM4T24C	RL	UL	5	19.4	21.6	24	26.4	1	34.7	11.5	44.9	107	9.4	725
SM4T24A	SM4T24CA	RM	UM	5	20.5	22.8	24	25.2	1	33.2	12	42.8	112	9.4	725
SM4T27	SM4T27C	RN	UN	5	21.8	24.3	27	29.7	1	39.1	10.2	50.5	95	9.6	625
SM4T27A	SM4T27CA	RP	UP	5	23.1	25.7	27	28.4	1	37.5	10.7	48.3	99	9.6	625
SM4T30	SM4T30C	RQ	UQ	5	24.3	27	30	33	1	43.5	9.2	56.1	86	9.7	575
SM4T30A	SM4T30CA	RR	UR	5	25.6	28.5	30	31.5	1	41.5	9.6	53.5	90	9.7	575
SM4T33	SM4T33C	RS	US	5	26.8	29.7	33	36.3	1	47.7	8.4	61.7	78	9.8	510
SM4T33A	SM4T33CA	RT	UT	5	28.2	31.4	33	34.7	1	45.7	8.8	59	81.5	9.8	510
SM4T36	SM4T36C	RU	UU	5	29.1	32.4	36	39.6	1	52	7.7	67.3	71	9.9	480
SM4T36A	SM4T36CA	RV	UV	5	30.8	34.2	36	37.8	1	49.9	8	64.3	74.5	9.9	480
SM4T39	SM4T39C	RW	UW	5	31.6	35.1	39	42.9	1	56.4	7.1	73	66	10.0	450
SM4T39A	SM4T39CA	RX	UX	5	33.3	37.1	39	41	1	53.9	7.4	69.7	69	10.0	450
SM4T68	SM4T68C	SN	WN	5	55.1	61.2	68	74.8	1	98	4.1	127	38	10.4	270
SM4T68A	SM4T68CA	SP	WP	5	58.1	64.6	68	71.4	1	92	4.3	121	39.5	10.4	270
SM4T100	SM4T100C	SW	WW	5	81	90	100	110	1	144	2.8	187	25.5	10.6	200
SM4T100A	SM4T100CA	SX	WX	5	85.5	95	100	105	1	137	2.9	178	27	10.6	200
SM4T150	SM4T150C	TH	XH	5	121	135	150	165	1	215	1.9	277	17.3	10.8	145
SM4T150A	SM4T150CA	TK	XK	5	128	143	150	158	1	207	2	265	18.1	10.8	145
SM4T200	SM4T200C	TS	XS	5	162	180	200	220	1	287	1.4	370	13	10.8	120
SM4T200A	SM4T200CA	TT	XT	5	171	190	200	210	1	274	1.5	353	13.6	10.8	120
SM4T220		TU		5	178	198	220	242	1	315	1.3	406	11.8	10.8	110
SM4T220A		TV		5	188	209	220	231	1	301	1.4	388	12.4	10.8	110

* Pulse test t_p ≤ 50 ms δ < 2 %.

** Divide these values by 2 for bidirectional types

For bidirectional types, electrical characteristics apply in both directions

ORDER CODE

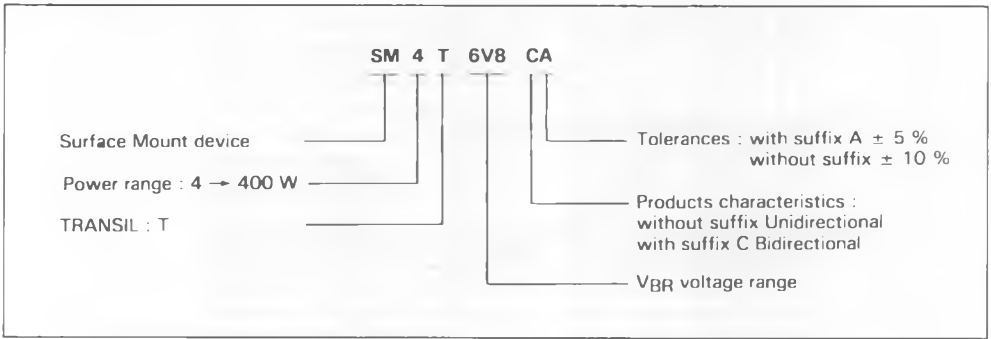

PACKAGE MECHANICAL DATA

SOD 6 Plastic

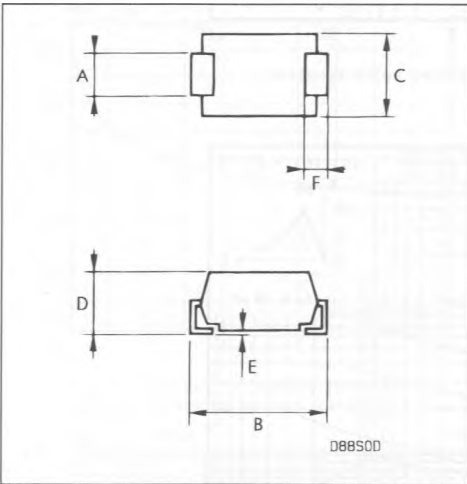

Ref.	Millimetres		Inches	
	Min.	Max.	Min.	Max.
A	2.8	3.2	0.110	0.126
B	6.0	6.4	0.236	0.252
C	3.8	4.2	0.150	0.165
D	2.5	3.1	0.098	0.122
E	—	0.1	—	0.004
F	0.9	1.3	0.035	0.051

Laser marking.
The logo indicates cathode for unidirectional types.

FOOT PRINT DIMENSIONS (Millimeters)

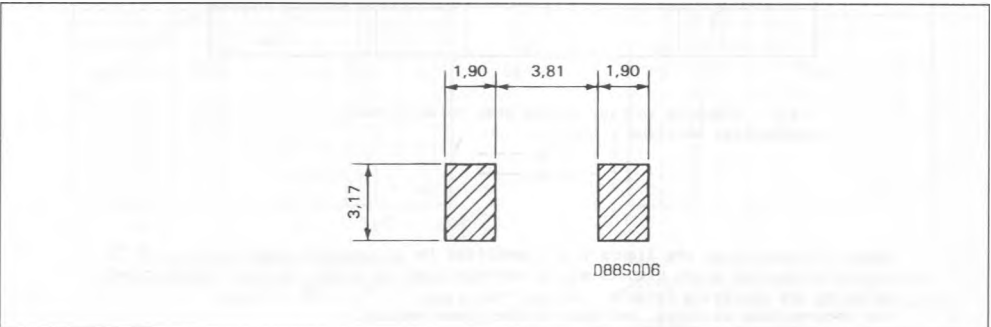

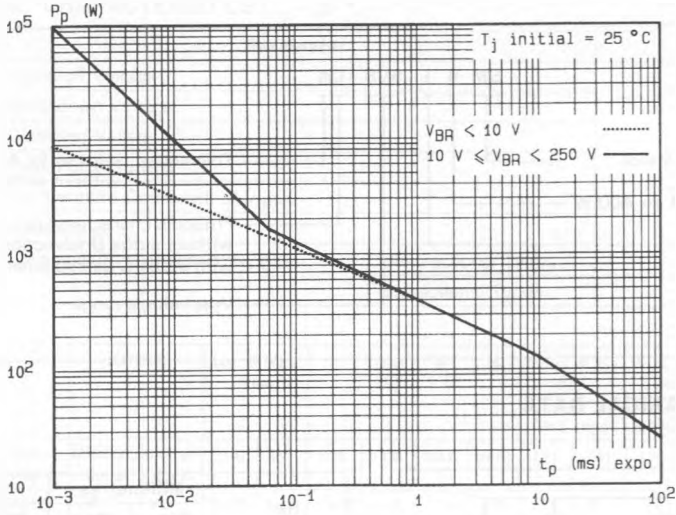

Fig.1 - Peak pulse power versus exponential pulse duration.

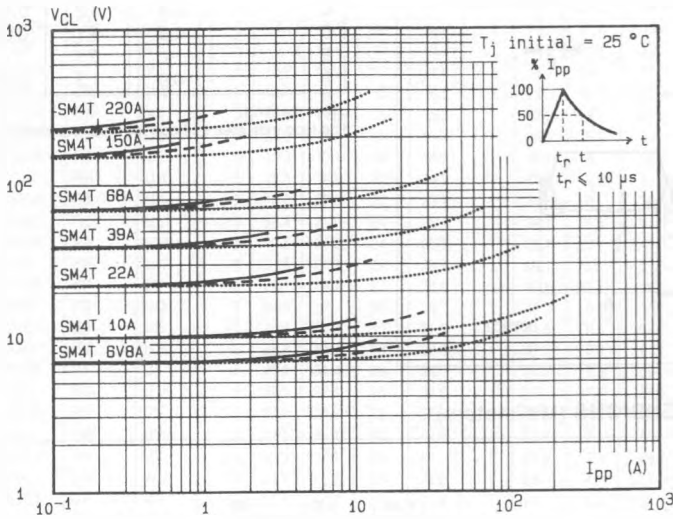

Fig.2 - Clamping voltage versus peak pulse current.
 exponential waveform $t = 20 \mu s$
 $t = 1 ms$ ----
 $t = 10 ms$ ———

Note : The curves of the figure 2 are specified for a junction temperature of 25 °C before surge. The given results may be extrapolated for other junction temperatures by using the following formula : $\Delta V (BR) = \alpha_T (V (BR)) \times [T_j - 25] \times V (BR)$
 For intermediate voltages, extrapolate the given results.

D88SM4TP4

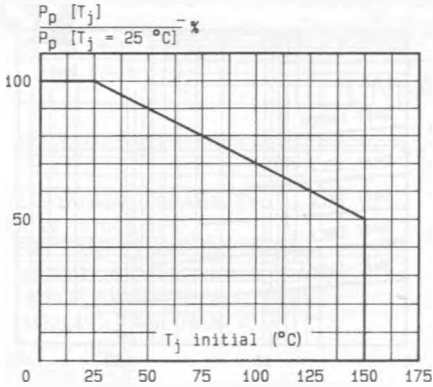

Fig. 3 - Allowable power dissipation versus junction temperature.

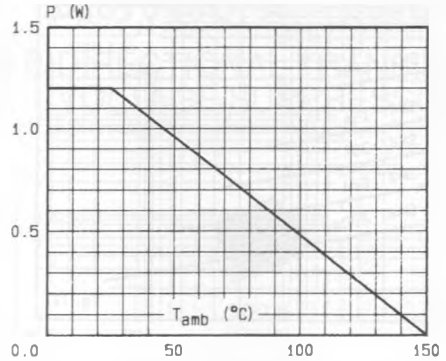

Fig. 4 - Power dissipation versus ambient temperature.

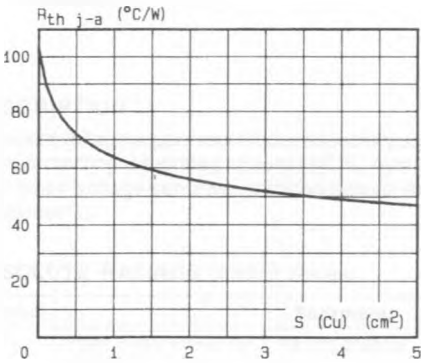

Fig. 5 - Thermal resistance junction-ambient versus Cu surface (printed circuit).

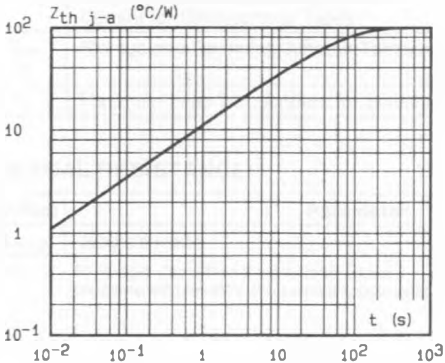

Fig. 6 - Transient thermal impedance junction-ambient versus pulse duration.

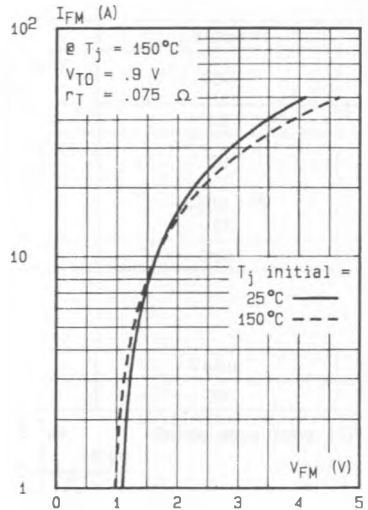

Fig. 7 - Peak forward current versus peak forward voltage drop (typical values for unidirectional types).

088SM4TP5

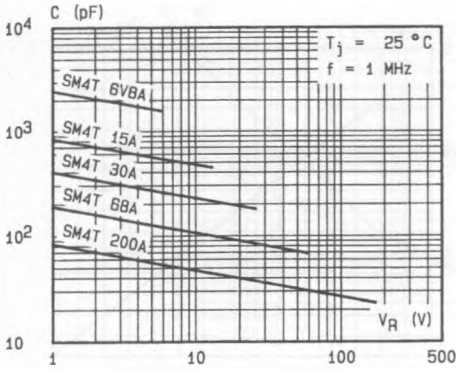

Fig.8a - Capacitance versus reverse applied voltage for unidirectional types (typical values).

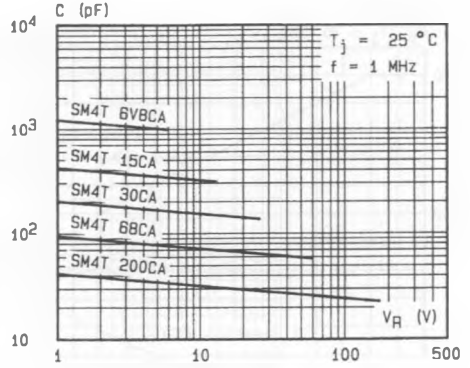

Fig.8b - Capacitance versus reverse applied voltage for bidirectional types (typical values).

088SM4TP6