



UNI-AND BIDIRECTIONAL TRANSIENT VOLTAGE SUPPRESSORS

- HIGH SURGE CAPABILITY :
1.5 kW / 1 ms EXPO
- VERY FAST CLAMPING TIME :
1 ps FOR UNIDIRECTIONAL TYPES
5 ns FOR BIDIRECTIONAL TYPES
- LARGE VOLTAGE RANGE :
5.5 V → 188 V
- ORDER CODE :
TYPE NUMBER FOR UNIDIRECTIONAL TYPES, TYPE NUMBER + SUFFIX C FOR BIDIRECTIONAL TYPES



SURFACE MOUNT TRANSIL FEATURES

- A PERFECT PICK AND PLACE BEHAVIOUR
- AN EXCELLENT ON BOARD STABILITY
- A FULL COMPATIBILITY WITH BOTH GLUING AND PASTE SOLDERING TECHNOLOGIES
- BODY MARKED WITH TYPE CODE AND LOGO
- STANDARD PACKAGING : 12 mm TAPE (EIA STD. RS481)
- TINNED COPPER LEADS
- HIGH TEMPERATURE RESISTANT RESIN

DESCRIPTION

Transient voltage suppressor diodes especially useful in protecting integrated circuits, MOS, hybrids and other voltage-sensitive semiconductors and components.

ABSOLUTE RATINGS (limiting values)

Symbol	Parameter	Value	Unit
P_p	Peak Pulse Power for 1 ms Exponential Pulse	T_j Initial = 25 °C See note 1	1500 W
P	Power Dissipation on Infinite Heatsink	$T_{amb} = 25$ °C	1.7 W
I_{FSM}	Non Repetitive Surge Peak Forward Current for Unidirectional Types	T_j Initial = 25 °C t = 10 ms	150 A
T_{stg} T_j	Storage and Operating Junction Temperature Range		- 65 to 175 °C °C
T_L	Maximum Lead Temperature for Soldering During 10 s		260 °C

THERMAL RESISTANCE

Symbol	Parameter	Value	Unit
$R_{th(j-l)}$	Junction-leads	10	°C/W

Note : 1. For surges upper than the maximum values, the diode will present a short-circuit anode-cathode.

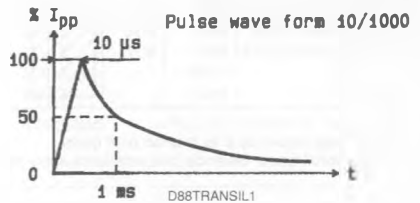

ELECTRICAL CHARACTERISTICS (T_J = 25 °C)

Symbol	Parameter	Value	
V _{RM}	Stand-off Voltage	See tables	
V _(BR)	Breakdown Voltage		
V _(CL)	Clamping Voltage		
I _{pp}	Peak Pulse Current		
α _T	Temperature Coefficient of V _(BR)		
C	Capacitance		
t _{clamping}	Clamping Time (0 volt to V _(BR))	Unidirectional Types	1 ps max.
		Bidirectional Types	5 ns max.

Types		Marking		I _{RM} @ V _{RM} max.		V _(BR) * @ I _R			V _(CL) @ I _{pp} max.		V _(CL) @ I _{pp} max.		α _T max.	C** typ. V _A =0 f=1MHz	
Unidirectional	Bidirectional	Unidirectional	Bidirectional	(μA)	(V)	min.	nom.	max.	(mA)	(V)	(A)	(V)	(A)	(10 ⁻⁴ /°C)	(pF)
									1ms expo		8-20μs expo				
SM15T6V8	SM15T6V8C	MDD	BDD	1000	5.5	6.12	6.8	7.48	10	10.8	139	14	714	5.7	9500
SM15T6V8A	SM15T6V8CA	MDE	BDE	1000	5.8	6.45	6.8	7.14	10	10.5	143	13.4	746	5.7	9500
SM15T7V5	SM15T7V5C	MDF	BDF	1000	6.05	6.75	7.5	8.25	10	11.7	128	15.2	660	6.1	8500
SM15T7V5A	SM15T7V5CA	MDF	BDF	1000	6.4	7.13	7.5	7.88	10	11.3	132	14.5	690	6.1	8500
SM15T10	SM15T10C	MDN	BDN	10	8.1	9.0	10	11	1	15	100	19.5	928	7.3	7000
SM15T10A	SM15T10CA	MDP	BDP	10	8.55	9.5	10	10.5	1	14.5	103	18.6	968	7.3	7000
SM15T12	SM15T12C	MDS	BDS	5	9.72	10.8	12	13.2	1	17.3	87	22.7	793	7.8	6000
SM15T12A	SM15T12CA	MDT	BDT	5	10.2	11.4	12	12.6	1	16.7	90	21.7	829	7.8	6000
SM15T15	SM15T15C	MDW	BDW	5	12.1	13.5	15	16.5	1	22	68	28.4	634	8.4	5000
SM15T15A	SM15T15CA	MDX	BDX	5	12.8	14.3	15	15.8	1	21.2	71	27.2	662	8.4	5000
SM15T18	SM15T18C	MED	BED	5	14.5	16.2	18	19.8	1	26.5	56.5	34	529	8.8	4300
SM15T18A	SM15T18CA	MEE	BEE	5	15.3	17.1	18	18.9	1	25.2	59.5	32.5	554	8.8	4300
SM15T22	SM15T22C	MEH	BEH	5	17.8	19.8	22	24.2	1	31.9	47	41.2	437	9.2	3700
SM15T22A	SM15T22CA	MEK	BEK	5	18.8	20.9	22	23.1	1	30.6	49	39.3	458	9.2	3700
SM15T24	SM15T24C	MEL	BEL	5	19.4	21.6	24	26.4	1	34.7	43	44.9	401	9.4	3500
SM15T24A	SM15T24CA	MEM	BEM	5	20.5	22.8	24	25.2	1	33.2	45	42.8	421	9.4	3500
SM15T27	SM15T27C	MEN	BEN	5	21.8	24.3	27	29.7	1	39.1	38.5	50.5	356	9.6	3200
SM15T27A	SM15T27CA	MEP	BEP	5	23.1	25.7	27	28.4	1	37.5	40	48.3	373	9.6	3200
SM15T30	SM15T30C	MEQ	BEQ	5	24.3	27	30	33	1	43.5	34.5	56.1	321	9.7	2900
SM15T30A	SM15T30CA	MER	BER	5	25.6	28.5	30	31.5	1	41.4	36	53.5	336	9.7	2900
SM15T33	SM15T33C	MES	BES	5	26.8	29.7	33	36.3	1	47.7	31.5	61.5	292	9.8	2700
SM15T33A	SM15T33CA	MET	BET	5	28.2	31.4	33	34.7	1	45.7	33	59	305	9.8	2700
SM15T36	SM15T36C	MEU	BEU	5	29.1	32.4	36	39.6	1	52	29	67.3	267	9.9	2500
SM15T36A	SM15T36CA	MEV	BEV	5	30.8	34.2	36	37.8	1	49.9	30	64.3	280	9.9	2500
SM15T39	SM15T39C	MEW	BEW	5	31.6	35.1	39	42.9	1	56.4	26.5	73	246	10.0	2400
SM15T39A	SM15T39CA	MEX	BEX	5	33.3	37.1	39	41	1	53.9	28	69.7	258	10.0	2400
SM15T68	SM15T68C	MFN	BFN	5	55.1	61.2	68	74.8	1	98	15.3	127	142	10.4	1550
SM15T68A	SM15T68CA	MFP	BFP	5	58.1	64.6	68	71.4	1	92	16.3	121	148	10.4	1550
SM15T100	SM15T100C	MFV	BFV	5	81	90	100	110	1	144	10.4	187	96	10.6	1150
SM15T100A	SM15T100CA	MFX	BFX	5	85.5	95	100	105	1	137	11	178	101	10.6	1150
SM15T150	SM15T150C	MGH	BGH	5	121	135	150	165	1	215	7	277	65	10.8	850
SM15T150A	SM15T150CA	MGK	BGK	5	128	143	150	158	1	207	7.2	265	68	10.8	850
SM15T200	SM15T200C	MGU	BGU	5	162	180	200	220	1	287	5.2	370	48	10.8	675
SM15T200A	SM15T200CA	MGV	BGV	5	171	190	200	210	1	274	5.5	353	51	10.8	675
SM15T220		MGW		5	175	198	220	242	1	344	4.3	406	44.5	10.8	625
SM15T220A		MGX		5	185	209	220	231	1	328	4.6	388	46.5	10.8	625

** Pulse test t_p < 50 ms δ < 2 %.

** Divide these values by 2 for bidirectional types.

For bidirectional types, electrical characteristics apply in both directions.

ORDER CODE

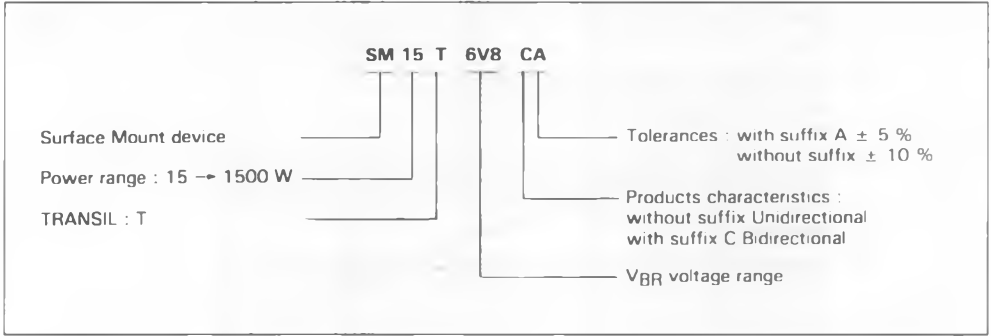

PACKAGE MECHANICAL DATA

SOD 15 Plastic

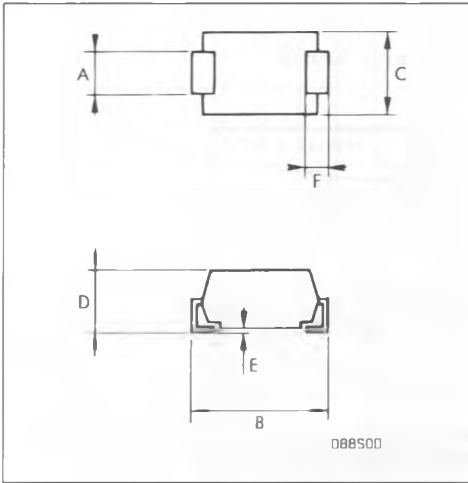

Ref.	Millimetres		Inches	
	Min.	Max.	Min.	Max.
A	2.8	3.2	0.110	0.126
B	7.6	8.0	0.300	0.315
C	4.8	5.2	0.190	0.200
D	2.5	3.1	0.098	0.122
E	—	0.1	—	0.004
F	1.3	1.7	0.051	0.067

Laser marking.
The logo indicates cathode for unidirectional types.

FOOT PRINT DIMENSIONS (Millimeters)

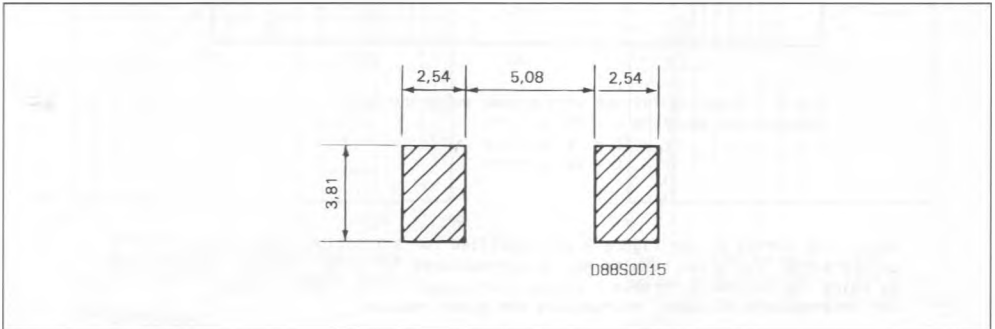

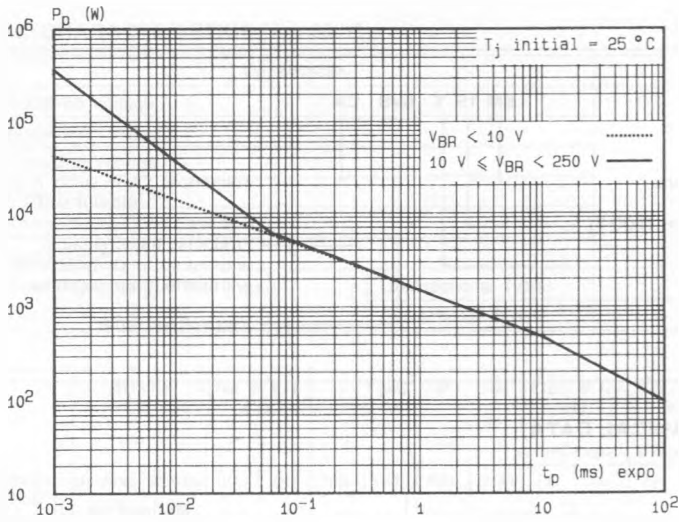

Fig.1 - Peak pulse power versus exponential pulse duration.

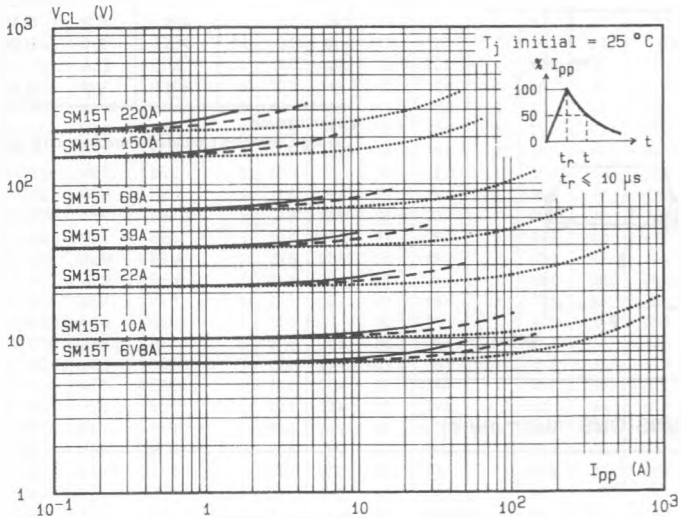

Fig.2 - Clamping voltage versus peak pulse current.
 exponential waveform $t = 20 \mu s$
 $t = 1$ ms - - -
 $t = 10$ ms ———

Note : The curves of the figure 2 are specified for a junction temperature of 25 °C before surge. The given results may be extrapolated for other junction temperatures by using the following formula : $\Delta V (BR) = \alpha T (V (BR)) \times [T_j - 25] \times V (BR)$
 For intermediate voltages, extrapolate the given results.

088SM15TP4

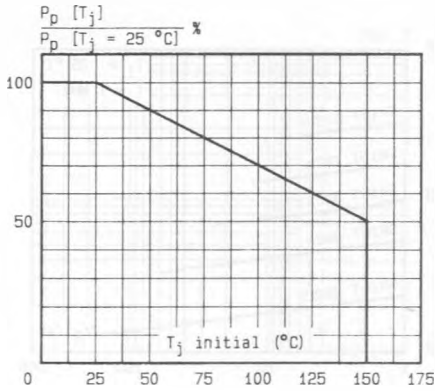

Fig.3 - Allowable power dissipation versus junction temperature.

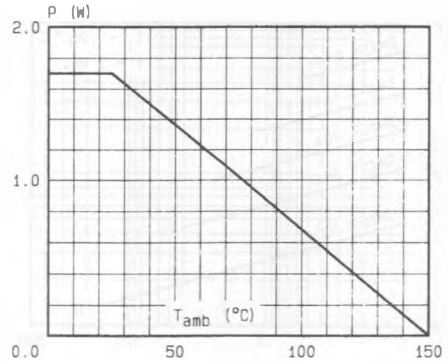

Fig.4 - Power dissipation versus ambient temperature.

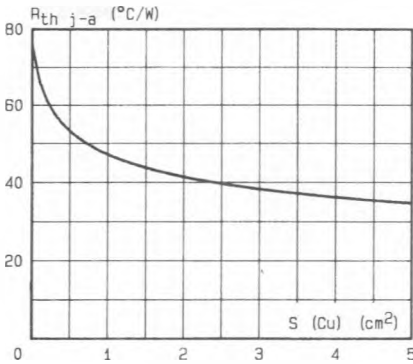

Fig.5 - Thermal resistance junction-ambient versus Cu surface (printed circuit).

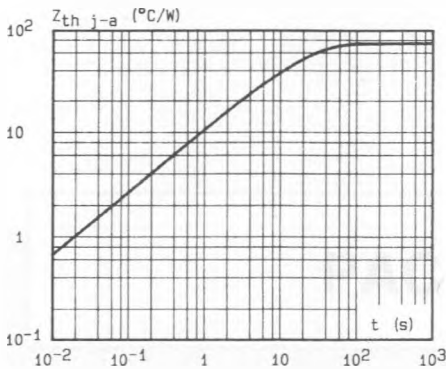

Fig.6 - Transient thermal impedance junction-ambient versus pulse duration.

088SM15TP5

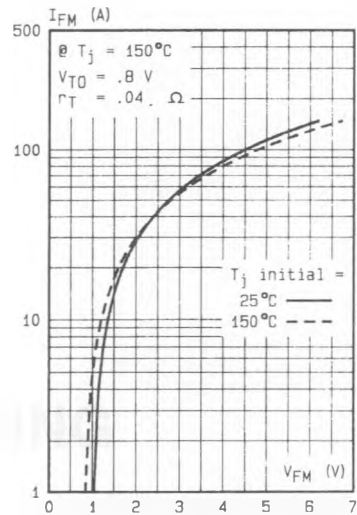

Fig.7 - Peak forward current versus peak forward voltage drop (typical values for unidirectional types).

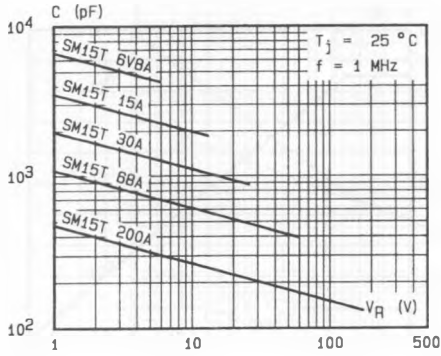

Fig.8a - Capacitance versus reverse applied voltage for unidirectional types (typical values).

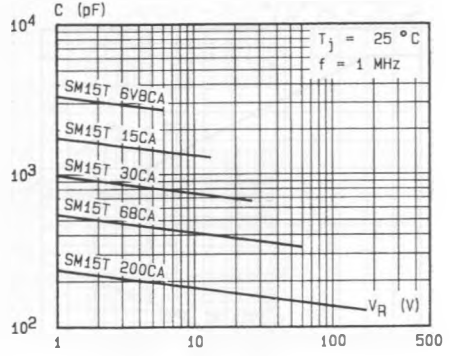

Fig.8b - Capacitance versus reverse applied voltage for bidirectional types (typical values).

DB8SM15TP6