

## Fast Recovery Rectifier Diodes

**SKN 135 F    SKR 135 F**  
**SKN 136 F    SKR 136 F**  
**SKN 140 F    SKR 140 F**  
**SKN 141 F    SKR 141 F**



### Features

- Small recovered charge
- Soft recovery
- Up to 1500 V reverse voltage
- Hermetic metal cases with glass insulators
- Threaded studs M12
- **SKN:** anode to stud
- **SKR:** cathode to stud

### Typical Applications

- Inverse diodes for GTO and asymmetric thyristors
- Inverters and choppers
- A. C. motor control, uninterruptible power supplies (UPS)

V <sub>RSM</sub> V <sub>RRM</sub>	IFRMS (maximum values for continuous operation) 260 A			
	I <sub>FAV</sub> (sin. 180; T <sub>case</sub> = 85 °C)			
	160 A		168 A	
	t <sub>rr</sub> = 500 ns		t <sub>rr</sub> = 800 ns	
V				
800	SKN 135 F 08 SKN 136 F 08	SKR 135 F 08 SKR 136 F 08	-	-
1000	SKN 135 F 10 SKN 136 F 10	SKR 135 F 10 SKR 136 F 10	-	-
1200	SKN 135 F 12 SKN 136 F 12	SKR 135 F 12 SKR 136 F 12	SKN 140 F 12 SKN 141 F 12	SKR 140 F 12 SKR 141 F 12
1400	-	-	SKN 140 F 14 SKN 141 F 14	SKR 140 F 14 SKR 141 F 14
1500	-	-	SKN 140 F 15 SKN 141 F 15	SKR 140 F 15 SKR 141 F 15

Symbol	Conditions	SKN135F SKR135F SKN136F SKR136F	SKN140F SKR140F SKN141F SKR141F	Units
I <sub>FAV</sub>	sin. 180; T <sub>case</sub> = 85 °C; 1000 Hz T <sub>case</sub> = 100 °C; 1000 Hz  sin. 180/ rec. 120 T <sub>amb</sub> = 45 °C; K 1,1 P 1/200 K 0,55 T <sub>amb</sub> = 35 °C; P 1/120 F K 1,1 F	160 135	168 140	A A
I <sub>FSM</sub>	T <sub>Vj</sub> = 25 °C; 10 ms T <sub>Vj</sub> = 150 °C; 10 ms	2500 2100	2500 2100	A A
i <sup>2</sup> t	T <sub>Vj</sub> = 25 °C; 8,3 ... 10 ms T <sub>Vj</sub> = 150 °C; 8,3 ... 10 ms	31000 22000	31000 22000	A <sup>2</sup> s A <sup>2</sup> s
Q <sub>rr</sub>	T <sub>Vj</sub> = 150 °C V <sub>R</sub> = 400 V	50 75	90 135	μC μC
I <sub>RM</sub>	$-\frac{di}{dt} = 100 \frac{A}{\mu s}$	53 69	90 115	A A
I <sub>R</sub>	T <sub>Vj</sub> = 25 °C; V <sub>R</sub> = V <sub>RRM</sub> T <sub>Vj</sub> = 150 °C; V <sub>R</sub> = V <sub>RRM</sub>	1 100	1 100	mA mA
t <sub>rr</sub>	T <sub>Vj</sub> = 25 °C T <sub>Vj</sub> = 150 °C } I <sub>F</sub> = I <sub>R</sub> = 1 A	max. 500 typ. 1	max. 800 typ. 1,6	ns μs
V <sub>F</sub>	T <sub>Vj</sub> = 25 °C; I <sub>F</sub> = 300 A	max. 1,95	max. 1,80	V
V <sub>(TO)</sub>	T <sub>Vj</sub> = 150 °C	1,1	1,1	V
r <sub>T</sub>	T <sub>Vj</sub> = 150 °C	2,3	2	mΩ
R <sub>thjc</sub>		0,2		°C/W
R <sub>thch</sub>		0,08		°C/W
T <sub>Vj</sub>		- 40 ... + 150		°C
T <sub>stg</sub>		- 55 ... + 150		°C
M	SI (US) units	10 (90 lb.in.)		Nm
a		5 · 9,81		m/s <sup>2</sup>
w	approx.	100		g
Case	135 F, 140 F 136 F, 141 F	E 14 E 31		

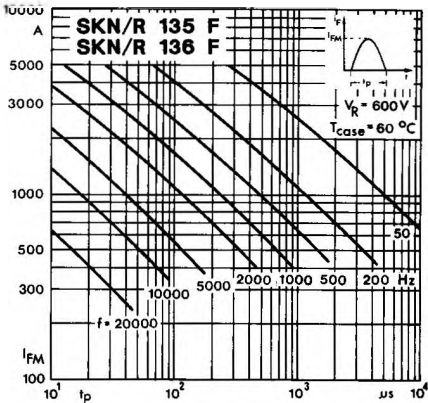

Fig. 1 a Rated sinusoidal peak forward current

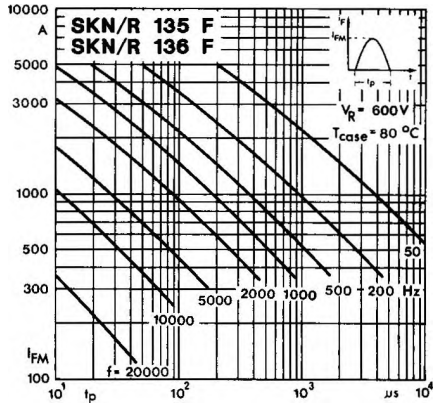

Fig. 1 b Rated sinusoidal peak forward current

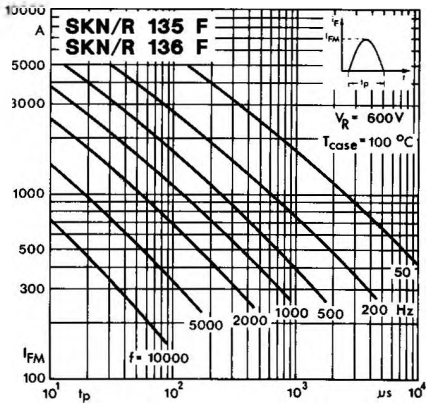

Fig. 1 c Rated sinusoidal peak forward current

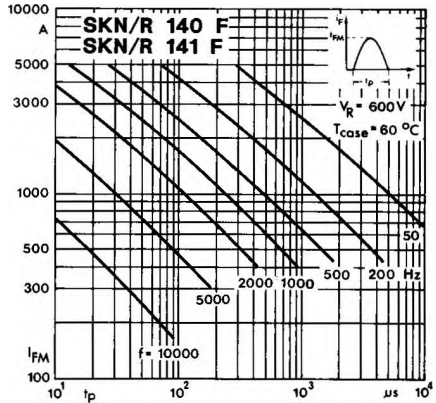

Fig. 1 d Rated sinusoidal peak forward current

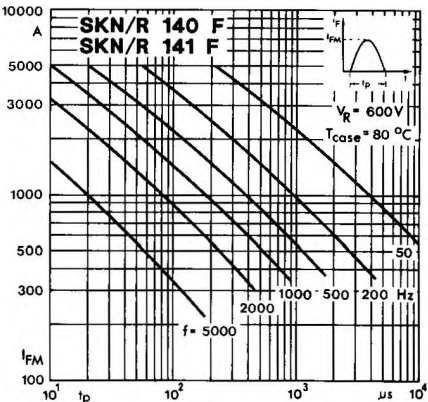

Fig. 1 e Rated sinusoidal peak forward current

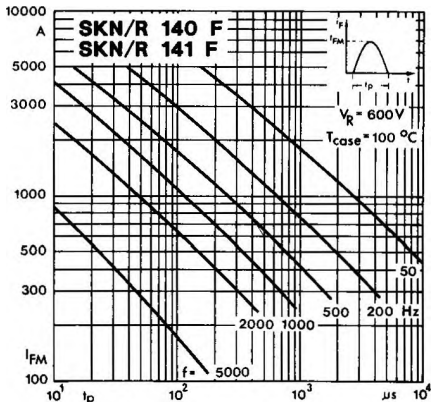

Fig. 1 f Rated sinusoidal peak forward current

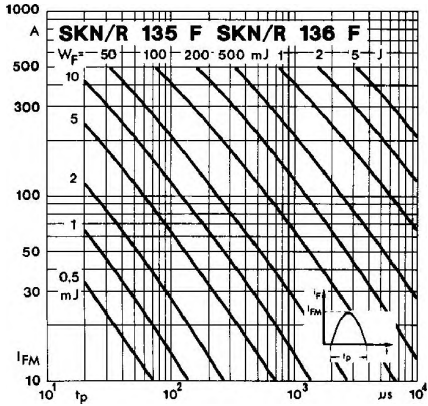

Fig. 2 a Forward energy dissipation, sinusoidal

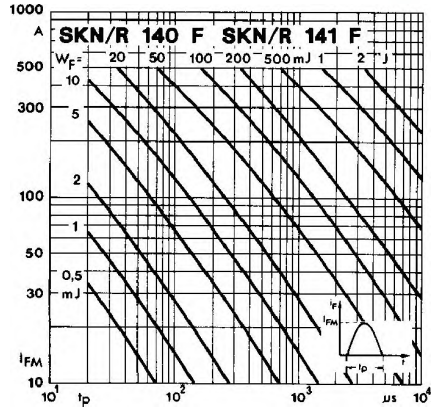

Fig. 2 b Forward energy dissipation, sinusoidal

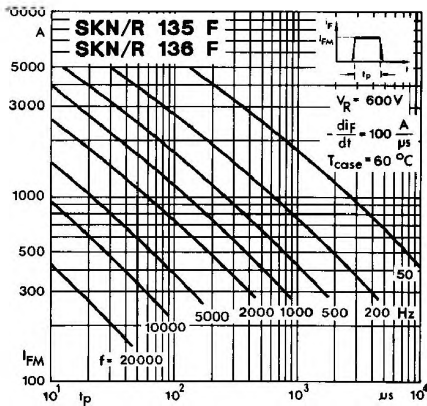

Fig. 3 a Rated rectangular peak forward current

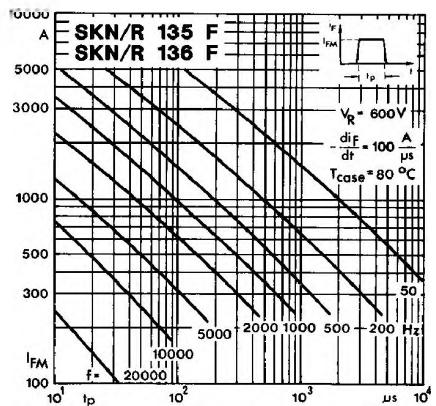

Fig. 3 b Rated rectangular peak forward current

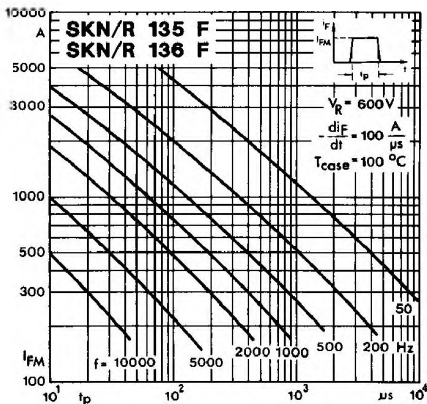

Fig. 3 c Rated rectangular peak forward current

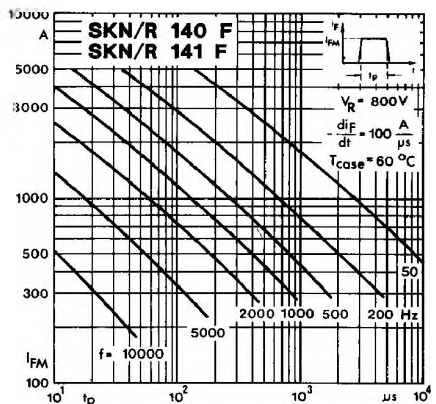

Fig. 3 d Rated rectangular peak forward current

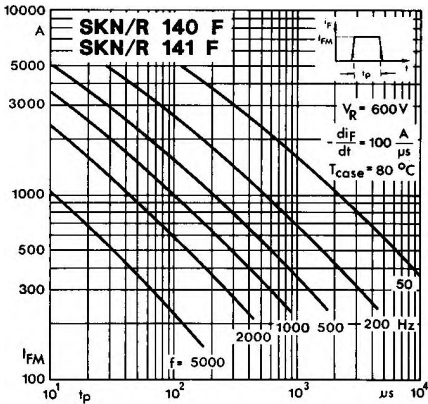

Fig. 3 e Rated rectangular peak forward current

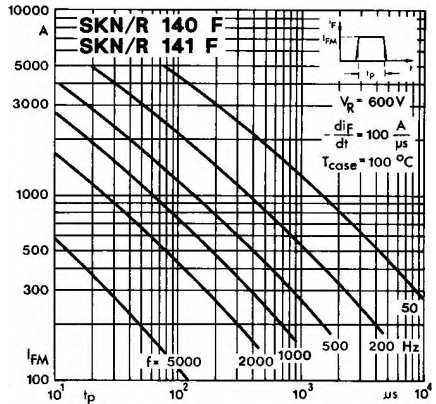

Fig. 3 f Rated rectangular peak forward current

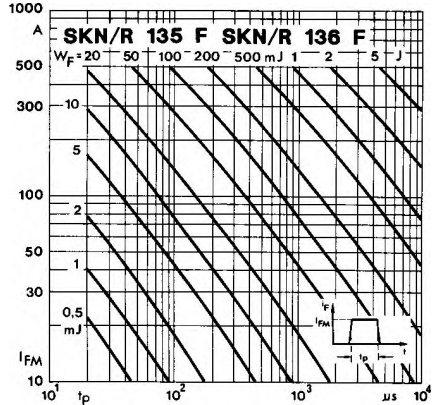

Fig. 4 a Forward energy dissipation, rectangular

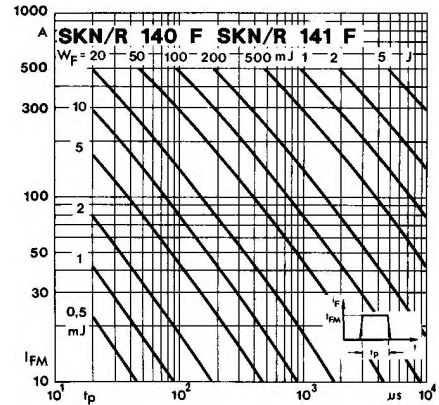

Fig. 4 b Forward energy dissipation, rectangular

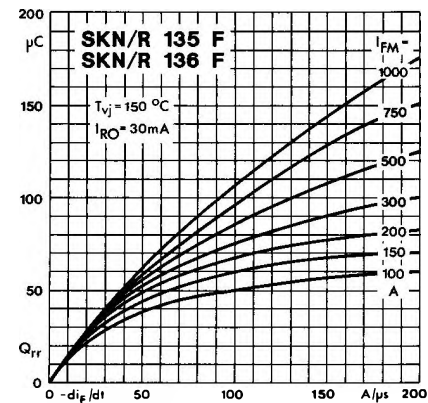

Fig. 5 a Recovered charge

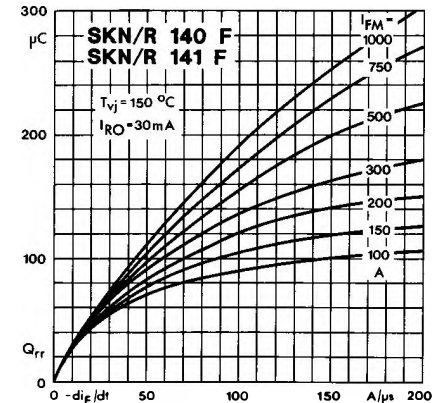

Fig. 5 b Recovered charge

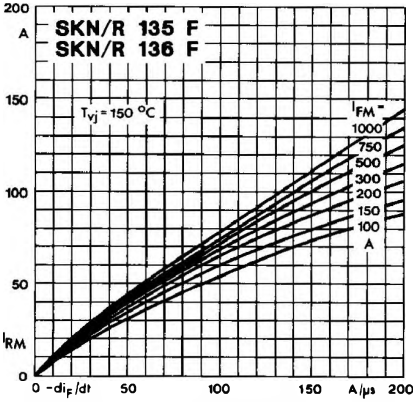

Fig. 6 a Peak reverse recovery current

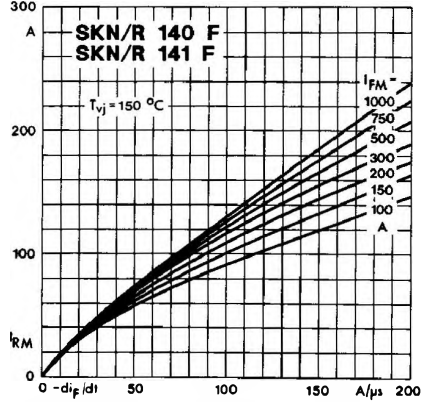

Fig. 6 b Peak reverse recovery current

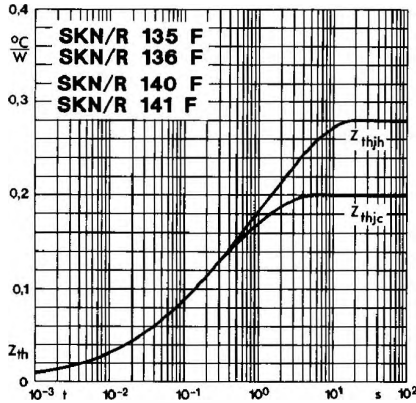

Fig. 7 Transient thermal impedance

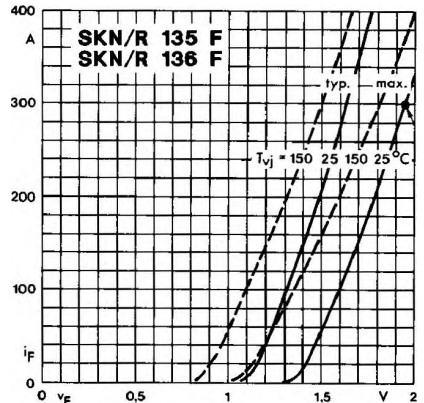

Fig. 8 a Forward characteristics

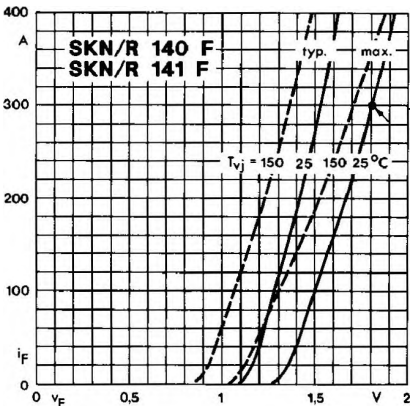

Fig. 8 b Forward characteristics

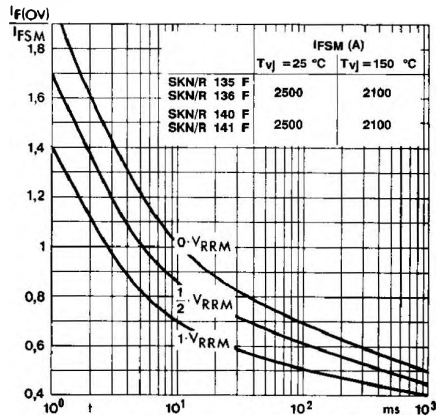
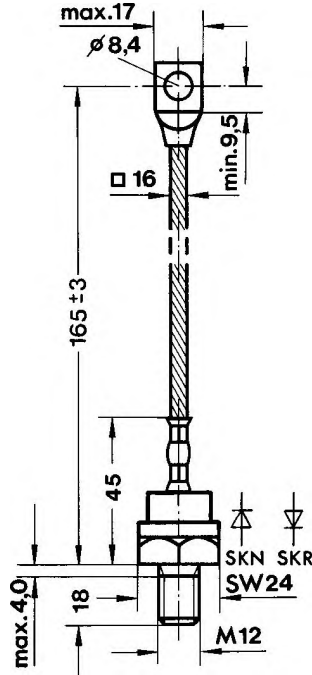

Fig. 9 Rated surge overload current

SKN 135 F  
 SKR 135 F  
 SKN 140 F  
 SKR 140 F

Case E 14

IEC: A 9 MA<sup>1)</sup>  
 DIN 41 887: 105 B 2<sup>1)</sup>  
 BS 3934: SO-29 B  
 JEDEC: DO-205 AC (DO-30)<sup>1)2)</sup>



Dimensions in mm

SKN 136 F  
 SKR 136 F  
 SKN 141 F  
 SKR 141 F

Case E 31

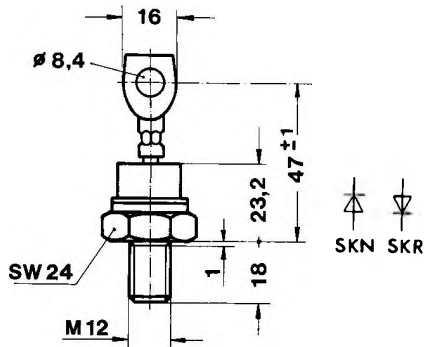

Dimensions in mm

<sup>1)</sup> modified

<sup>2)</sup> These types are also available with the original DO-205 AA (DO-8) dimensions with thread 3/8-24.