

## Rectifier Diodes

**SK 1**      **SK 3**  
**SKa 1**     **SKa 3**

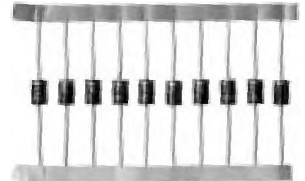

$V_{RSM}$ $V_{RRM}$	IFRMS (maximum values for continuous operation)					
	3 A			6,7 A		
V	IFAV (sin. 180; $T_{amb} = 45\text{ }^{\circ}\text{C}$ )					
	1,15 A			1,8 A		
	Types	$C_{max.}$ $\mu\text{F}$	$R_{min.}$ $\Omega$	Types	$C_{max.}$ $\mu\text{F}$	$R_{min.}$ $\Omega$
1000	<b>SK 1/10</b>	500	4	<b>SK 3/10</b>	2000	1
1200	<b>SK 1/12</b>	400	6	<b>SK 3/12</b>	1600	2
1400	<b>SK 1/14</b>	300	8	<b>SK 3/14</b>	1200	3
1600	<b>SK 1/16</b>	200	10	<b>SK 3/16</b>	800	4
$V_{(BR)}$ min	Avalanche Types					
1300	<b>SKa 1/13</b>	400	6	<b>SKa 3/13</b>	1600	2
1700	<b>SKa 1/17</b>	200	10	<b>SKa 3/17</b>	800	4

Symbol	Conditions	SK 1 SKa 1	SK 3 SKa 3	Units
IFAV	$T_{ref} = 85\text{ }^{\circ}\text{C}$ ; L = 10 mm; sin. 180 $T_{amb} = 45\text{ }^{\circ}\text{C}$ ; p.c.b. 50 x 50 mm	1,45	3,3	A
		1,15	1,8	A
IFSM	$T_{vj} = 25\text{ }^{\circ}\text{C}$ ; 10 ms $T_{vj} = 150\text{ }^{\circ}\text{C}$ ; 10 ms	60	180	A
		50	150	A
$i^2t$	$T_{vj} = 25\text{ }^{\circ}\text{C}$ ; 8,3 ... 10 ms $T_{vj} = 150\text{ }^{\circ}\text{C}$ ; 8,3 ... 10 ms	18	162	$\text{A}^2\text{s}$
		12,5	112,5	$\text{A}^2\text{s}$
$Q_{rr}$	$T_{vj} = 150\text{ }^{\circ}\text{C}$ ; $-\frac{dI_F}{dt} = 10 \frac{\text{A}}{\mu\text{s}}$ ; $I_F = 10\text{ A}$ ; $V_R = 100\text{ V}$ ; typ.	10	25	$\mu\text{C}$
$I_R$	$T_{vj} = 25\text{ }^{\circ}\text{C}$ ; $V_R = V_{RRM} / V_{(BR)min}$ $T_{vj} = 150\text{ }^{\circ}\text{C}$ ; $V_R = V_{RRM} / V_{(BR)min}$	4	4	$\mu\text{A}$
		400	600	$\mu\text{A}$
$P_{RSM}$	SKa-Types only $T_{vj} = 150\text{ }^{\circ}\text{C}$ ; $t_p = 10\text{ }\mu\text{s}$	1	3	kW
$V_F$	$T_{vj} = 25\text{ }^{\circ}\text{C}$ ; $I_F = 10\text{ A}$ ; max.	1,5	1,2	V
$V_{(TO)}$	$T_{vj} = 150\text{ }^{\circ}\text{C}$	0,85	0,85	V
$r_T$	$T_{vj} = 150\text{ }^{\circ}\text{C}$	75	30	$\text{m}\Omega$
$C_j$	$V_R = 0$ ; $f = 1\text{ MHz}$ ; typ.	45	110	pF
$R_{thjr}$	L = 10 mm	40	18	$^{\circ}\text{C}/\text{W}$
$R_{thja}$	p.c.b. 50 x 50 mm	85	60	$^{\circ}\text{C}/\text{W}$
$T_{vj}$		- 40 ... + 150		$^{\circ}\text{C}$
$T_{stg}$		- 40 ... + 150		$^{\circ}\text{C}$
$T_{solder}$	max. 10 s; L $\geq$ 9 mm	250		$^{\circ}\text{C}$
a		5 · 9,81		$\text{m/s}^2$
w	approx.	0,5	1	g

### Features

- Axial lead diodes
- Taped for automatic insertion
- Available with formed leads on request
- Plastic material carries Underwriters Laboratories flammability classification 94V-0

### SKa types

- Avalanche type reverse characteristics
- Minimum avalanche breakthrough voltages 1300 V and 1700 V
- Transient voltage proof within specified limits

### Typical Applications

- All-purpose rectifier diodes
- For p.c.b. mounting

### SKa types

- DC supply for magnets or solenoids (brakes, valves, etc.)
- Series connections for high voltage applications (dust precipitators)

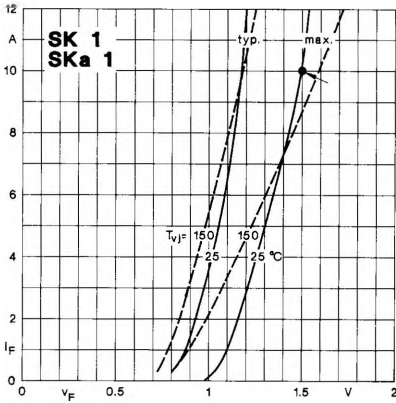

Fig. 6 a Forward characteristics

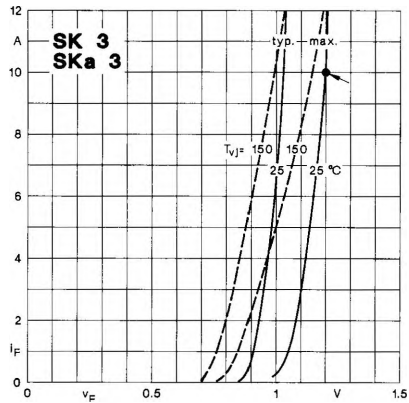

Fig. 6 b Forward characteristics

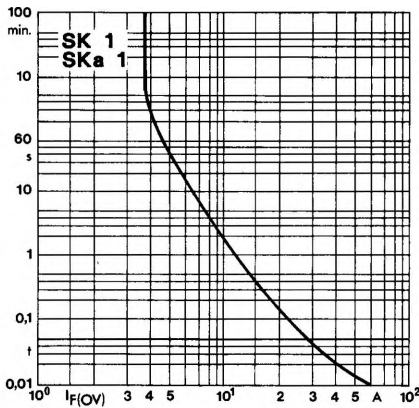

Fig. 10 a Rated overload current vs. time

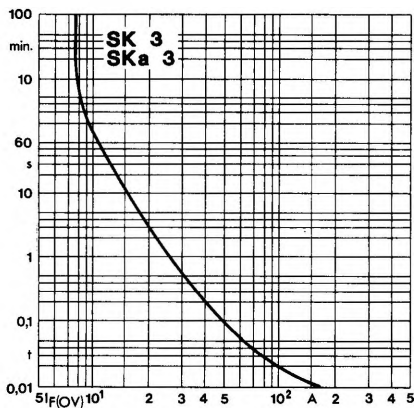

Fig. 10 b Rated overload current vs. time

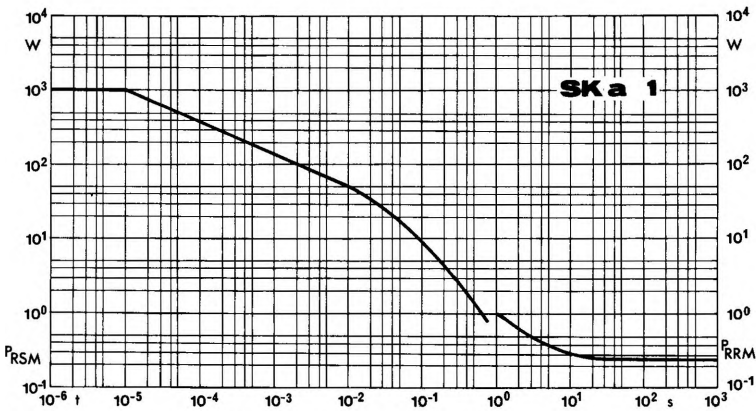

Fig. 11 a Rated reverse power dissipation vs. time

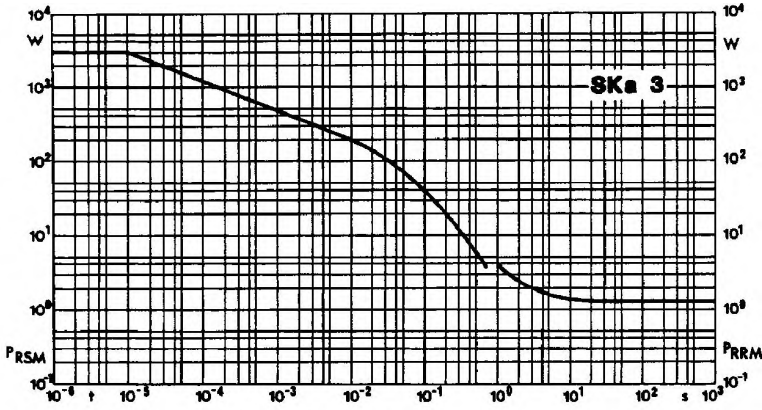

Fig. 11 b Rated reverse power dissipation vs. time

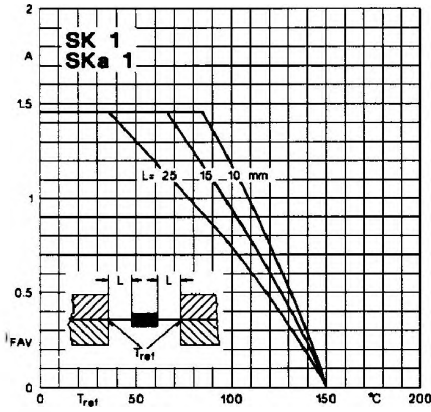

Fig. 14 a Rated forward current vs. reference temp.

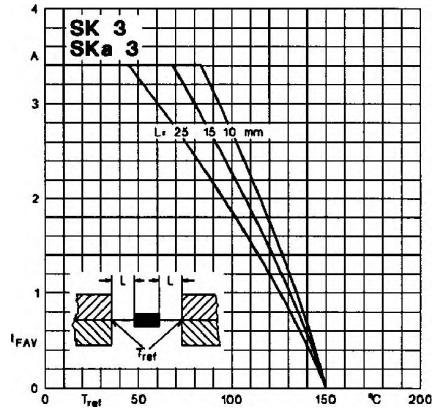

Fig. 14 b Rated forward current vs. reference temp.

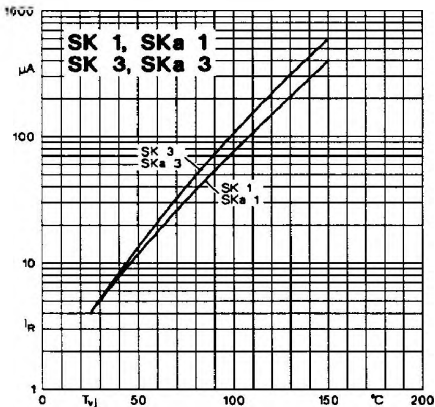

Fig. 15 Reverse current vs. virt. junction temp.

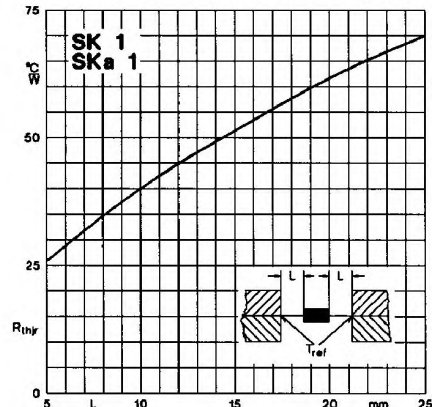

Fig. 16 a Thermal resistance vs. lead length

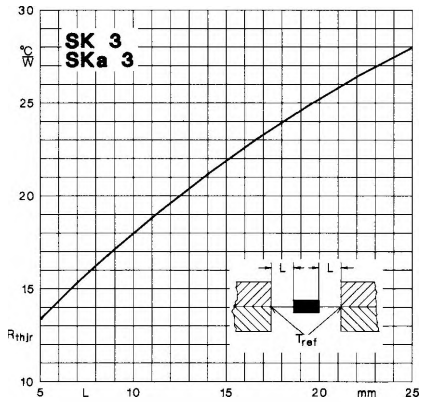
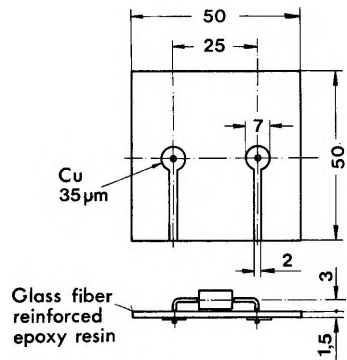
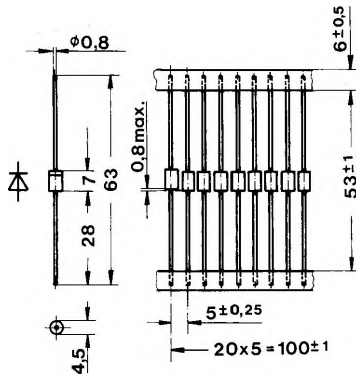

Fig. 16 b Thermal resistance vs. lead length

P.C.B. for  $R_{thja} = 85 \text{ }^\circ\text{C/W}$  (SK 1)  
 $R_{thja} = 60 \text{ }^\circ\text{C/W}$  (SK 3)



**SK 1**  
**SKa 1**  
Case E 33



3500 diodes per reel

**SK 3**  
**SKa 3**  
Case E 34

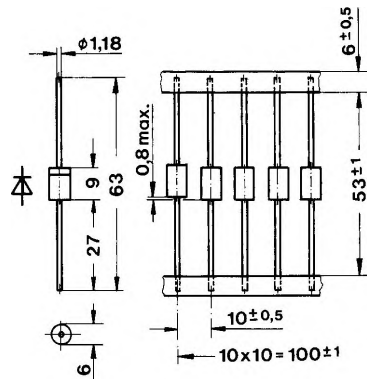

1500 diodes per reel

Reel dimensions page B 8 - 2

Dimensions in mm