

# P6KE6.8A Series

## Zener Transient Voltage Suppressors

### Unidirectional and Bidirectional

The P6KE6.8A series is designed to protect voltage sensitive components from high voltage, high energy transients. They have excellent clamping capability, high surge capability, low zener impedance and fast response time. The P6KE6.8A series is supplied in ON Semiconductor's exclusive, cost-effective, highly reliable Surmetic axial leaded package and is ideally-suited for use in communication systems, numerical controls, process controls, medical equipment, business machines, power supplies and many other industrial/consumer applications.

#### Specification Features:

- Standard Zener Voltage Range — 6.8 to 200 V
- Peak Power — 600 Watts @ 1 ms
- Maximum Clamp Voltage @ Peak Pulse Current
- Low Leakage < 5  $\mu$ A Above 10 V
- Maximum Temperature Coefficient Specified
- UL Recognition
- Response Time is Typically < 1 ns

#### Mechanical Characteristics:

**CASE:** Void-free, transfer-molded, thermosetting plastic

**FINISH:** All external surfaces are corrosion resistant and leads are readily solderable

**POLARITY:** Cathode indicated by polarity band. When operated in zener mode, will be positive with respect to anode

**MOUNTING POSITION:** Any

**WAFER FAB LOCATION:** Phoenix, Arizona

**ASSEMBLY/TEST LOCATION:** Seoul, Korea



**ON Semiconductor**

Formerly a Division of Motorola

<http://onsemi.com>

### SURMETIC-40 ZENER OVERVOLTAGE TRANSIENT SUPPRESSORS 6.8-200 VOLTS 600 WATT PEAK POWER 5 WATTS STEADY STATE

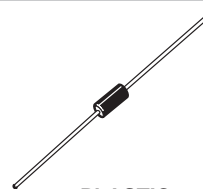

PLASTIC  
CASE 17

#### ORDERING INFORMATION

Device	Package	Shipping
P6KEXXA	CASE 17	1000 Units/Box
P6KEXXARL	CASE 17	Tape and Reel 4000 Units/Reel
P6KEXXCA Bidirectional	CASE 17	1000 Units/Box
P6KEXXCARL Bidirectional	CASE 17	Tape and Reel 4000 Units/Reel

Devices listed in **bold, italic** are ON Semiconductor **Preferred** devices. **Preferred** devices are recommended choices for future use and best overall value.

#### MAXIMUM RATINGS

Rating	Symbol	Value	Unit
Peak Power Dissipation (1) @ $T_L \leq 25^\circ\text{C}$	PPK	600	Watts
Steady State Power Dissipation @ $T_L \leq 75^\circ\text{C}$ , Lead Length = 3/8" Derated above $T_L = 75^\circ\text{C}$	$P_D$	5 50	Watts mW/ $^\circ\text{C}$
Forward Surge Current (2) @ $T_A = 25^\circ\text{C}$	I <sub>FSM</sub>	100	Amps
Operating and Storage Temperature Range	$T_J, T_{stg}$	-55 to +150	$^\circ\text{C}$

Lead temperature not less than 1/16" from the case for 10 seconds: 230 $^\circ\text{C}$

NOTES: 1. Nonrepetitive current pulse per Figure 4 and derated above  $T_A = 25^\circ\text{C}$  per Figure 2.

2. 1/2 sine wave (or equivalent square wave), PW = 8.3 ms, duty cycle = 4 pulses per minute maximum.

## P6KE6.8A Series

**ELECTRICAL CHARACTERISTICS** ( $T_A = 25^\circ\text{C}$  unless otherwise noted)  $V_F = 3.5\text{ V Max}$ ,  $I_F^{**} = 50\text{ A}$   
(except bidirectional devices).

Device	Breakdown Voltage*				Working Peak Reverse Voltage $V_{RWM}$ (Volts)	Maximum Reverse Leakage @ $V_{RWM}$ $I_R$ ( $\mu\text{A}$ )	Maximum Reverse Surge Current $I_{RSM}^\dagger$ (Amps)	Maximum Reverse Voltage @ $I_{RSM}$ (Clamping Voltage) $V_{RSM}$ (Volts)	Maximum Temperature Coefficient of $V_{BR}$ ( $\%/^\circ\text{C}$ )
	$V_{BR}$ (Volts)			@ $I_T$ (mA)					
	Min	Nom	Max						
<b>P6KE6.8A</b>	6.45	6.8	7.14	10	5.8	1000	57	10.5	0.057
P6KE7.5A	7.13	7.5	7.88	10	6.4	500	53	11.3	0.061
P6KE8.2A	7.79	8.2	8.61	10	7.02	200	50	12.1	0.065
P6KE9.1A	8.65	9.1	9.55	1	7.78	50	45	13.4	0.068
P6KE10A	9.5	10	10.5	1	8.55	10	41	14.5	0.073
P6KE11A	10.5	11	11.6	1	9.4	5	38	15.6	0.075
P6KE12A	11.4	12	12.6	1	10.2	5	36	16.7	0.078
P6KE13A	12.4	13	13.7	1	11.1	5	33	18.2	0.081
<b>P6KE15A</b>	<b>14.3</b>	<b>15</b>	<b>15.8</b>	<b>1</b>	<b>12.8</b>	<b>5</b>	<b>28</b>	<b>21.2</b>	<b>0.084</b>
P6KE16A	15.2	16	16.8	1	13.6	5	27	22.5	0.086
P6KE18A	17.1	18	18.9	1	15.3	5	24	25.2	0.088
P6KE20A	19	20	21	1	17.1	5	22	27.7	0.09
P6KE24A	22.8	24	25.2	1	20.5	5	18	33.2	0.094
P6KE27A	25.7	27	28.4	1	23.1	5	16	37.5	0.096
P6KE30A	28.5	30	31.5	1	25.6	5	14.4	41.4	0.097
P6KE33A	31.4	33	34.7	1	28.2	5	13.2	45.7	0.098
P6KE36A	34.2	36	37.8	1	30.8	5	12	49.9	0.099
P6KE39A	37.1	39	41	1	33.3	5	11.2	53.9	0.1
P6KE43A	40.9	43	45.2	1	36.8	5	10.1	59.3	0.101
P6KE47A	44.7	47	49.4	1	40.2	5	9.3	64.8	0.101
P6KE51A	48.5	51	53.6	1	43.6	5	8.6	70.1	0.102
P6KE56A	53.2	56	58.8	1	47.8	5	7.8	77	0.103
P6KE62A	58.9	62	65.1	1	53	5	7.1	85	0.104
P6KE68A	64.6	68	71.4	1	58.1	5	6.5	92	0.104
P6KE75A	71.3	75	78.8	1	64.1	5	5.8	103	0.105
P6KE82A	77.9	82	86.1	1	70.1	5	5.3	113	0.105
P6KE91A	86.5	91	95.5	1	77.8	5	4.8	125	0.106
P6KE100A	95	100	105	1	85.5	5	4.4	137	0.106
P6KE120A	114	120	126	1	102	5	3.6	165	0.107
P6KE130A	124	130	137	1	111	5	3.3	179	0.107
P6KE150A	143	150	158	1	128	5	2.9	207	0.108
P6KE170A	162	170	179	1	145	5	2.6	234	0.108
P6KE180A	171	180	189	1	154	5	2.4	246	0.108
P6KE200A	190	200	210	1	171	5	2.2	274	0.108

Devices listed in bold, italic are ON Semiconductor Preferred devices.

\*  $V_{BR}$  measured after  $I_T$  applied for 300  $\mu\text{s}$ ,  $I_T$  = square wave pulse or equivalent.

\*\* 1/2 sine wave (or equivalent square wave),  $PW = 8.3\text{ ms}$ , duty cycle = 4 pulses per minute maximum.

† Surge current waveform per Figure 4 and derate per Figure 2.

**FOR BIDIRECTIONAL APPLICATIONS —**  
**USE CA SUFFIX for P6KE6.8CA through P6KE200CA.**  
 Electrical characteristics apply in both directions.

**Preferred Bidirectional Devices —**  
**P6KE7.5CA    P6KE11CA    P6KE20CA**  
**P6KE22CA    P6KE27CA    P6KE30CA**

# P6KE6.8A Series

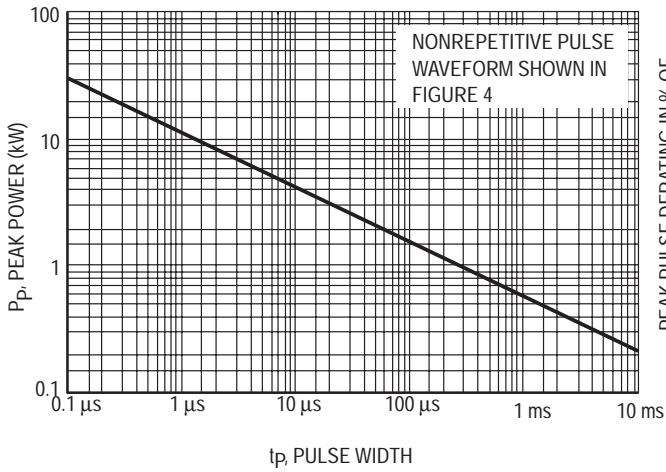

Figure 1. Pulse Rating Curve

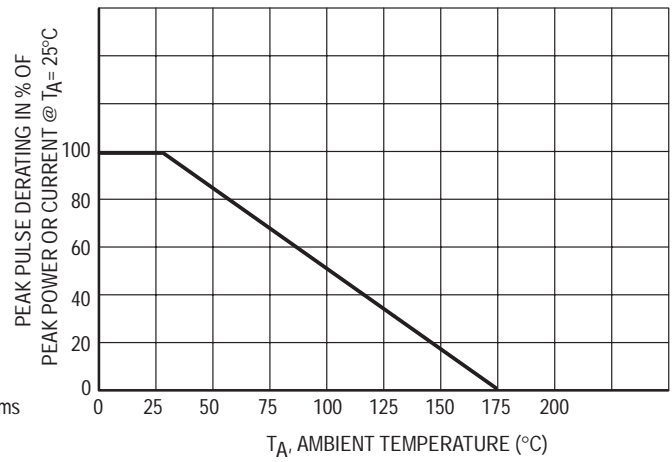

Figure 2. Pulse Derating Curve

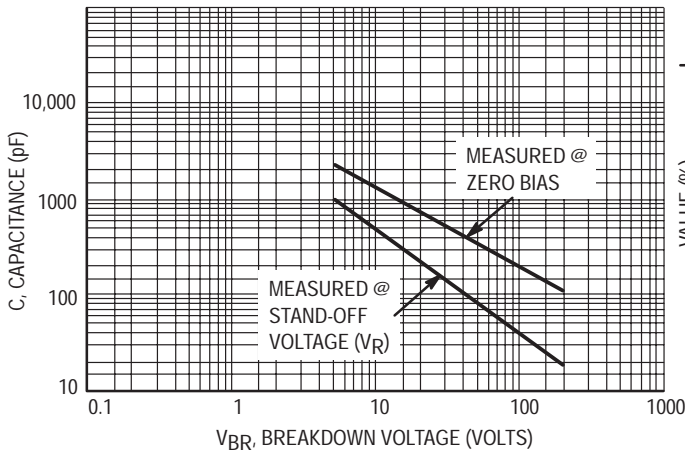

Figure 3. Capacitance versus Breakdown Voltage

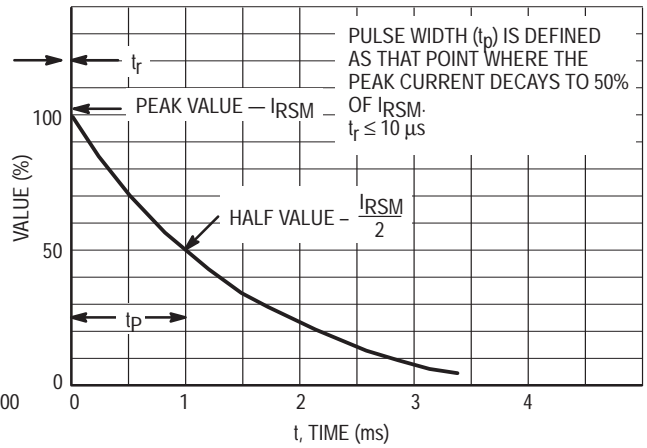

Figure 4. Pulse Waveform

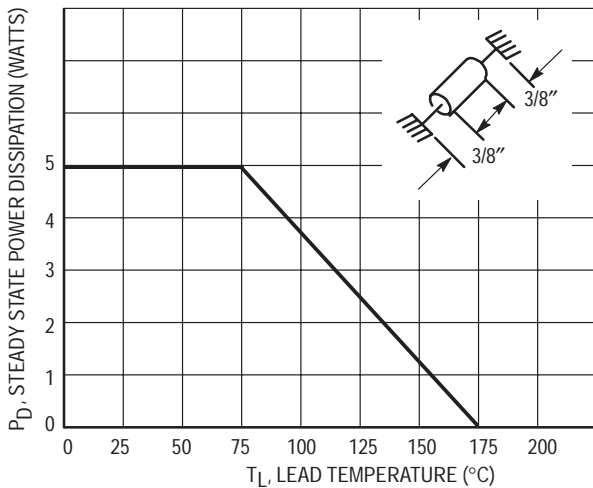

Figure 5. Steady State Power Derating

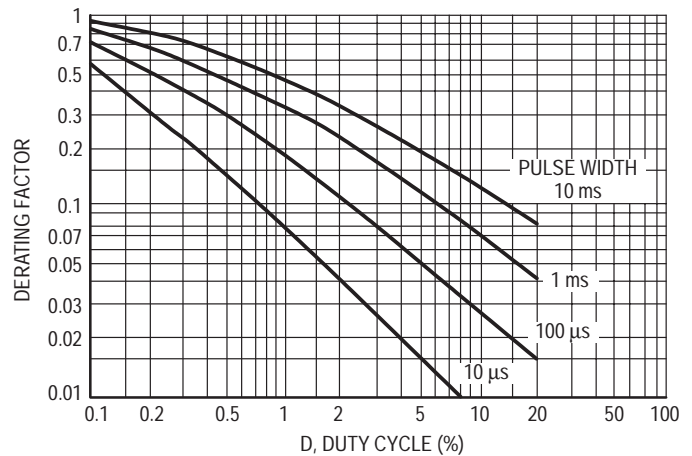

Figure 6. Typical Derating Factor for Duty Cycle

# P6KE6.8A Series

## APPLICATION NOTES

### RESPONSE TIME

In most applications, the transient suppressor device is placed in parallel with the equipment or component to be protected. In this situation, there is a time delay associated with the capacitance of the device and an overshoot condition associated with the inductance of the device and the inductance of the connection method. The capacitance effect is of minor importance in the parallel protection scheme because it only produces a time delay in the transition from the operating voltage to the clamp voltage as shown in Figure A.

The inductive effects in the device are due to actual turn-on time (time required for the device to go from zero current to full current) and lead inductance. This inductive effect produces an overshoot in the voltage across the equipment or component being protected as shown in Figure B. Minimizing this overshoot is very important in the application, since the main purpose for adding a transient suppressor is to clamp voltage spikes. The P6KE6.8A series has very good response time, typically  $< 1$  ns and negligible inductance. However, external inductive effects could produce unacceptable overshoot. Proper circuit layout,

minimum lead lengths and placing the suppressor device as close as possible to the equipment or components to be protected will minimize this overshoot.

Some input impedance represented by  $Z_{in}$  is essential to prevent overstress of the protection device. This impedance should be as high as possible, without restricting the circuit operation.

### DUTY CYCLE DERATING

The data of Figure 1 applies for non-repetitive conditions and at a lead temperature of 25°C. If the duty cycle increases, the peak power must be reduced as indicated by the curves of Figure 6. Average power must be derated as the lead or ambient temperature rises above 25°C. The average power derating curve normally given on data sheets may be normalized and used for this purpose.

At first glance the derating curves of Figure 6 appear to be in error as the 10 ms pulse has a higher derating factor than the 10  $\mu$ s pulse. However, when the derating factor for a given pulse of Figure 6 is multiplied by the peak power value of Figure 1 for the same pulse, the results follow the expected trend.

# P6KE6.8A Series

## TYPICAL PROTECTION CIRCUIT

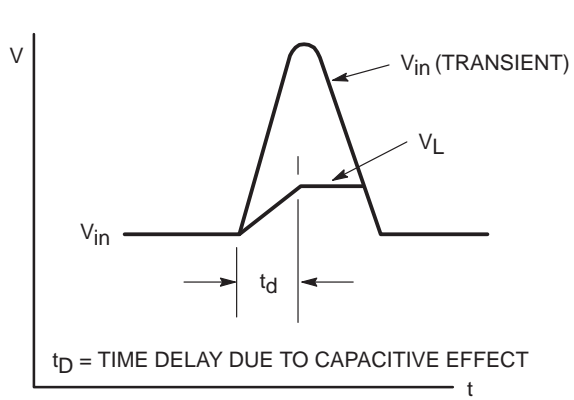
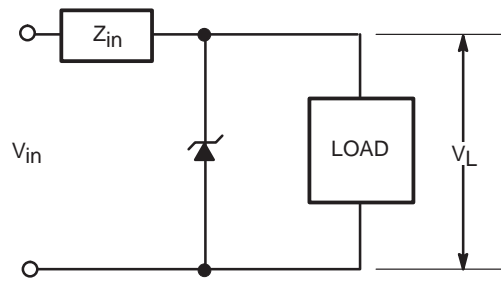

Figure 7.

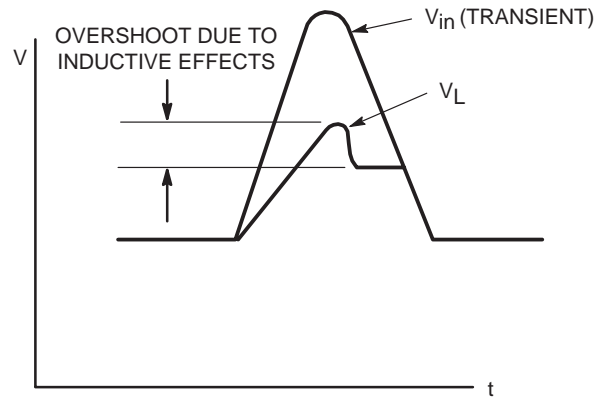

Figure 8.

## P6KE6.8A Series

### UL RECOGNITION

The entire series including the bidirectional CA suffix has *Underwriters Laboratory Recognition* for the classification of protectors (QVGV2) under the UL standard for safety 497B and File #E 116110. Many competitors only have one or two devices recognized or have recognition in a non-protective category. Some competitors have no recognition at all. With the UL497B recognition, our parts successfully passed several tests including Strike Voltage

Breakdown test, Endurance Conditioning, Temperature test, Dielectric Voltage-Withstand test, Discharge test and several more.

Whereas, some competitors have only passed a flammability test for the package material, we have been recognized for much more to be included in their protector category.

# P6KE6.8A Series

## OUTLINE DIMENSIONS

# Transient Voltage Suppressors — Axial Leaded

## 600 Watt Peak Power

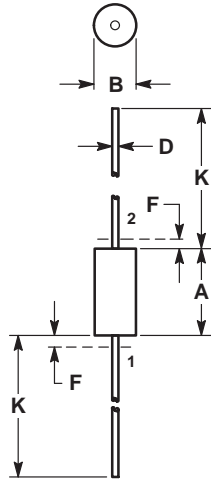

NOTE:  
1. LEAD DIAMETER & FINISH NOT CONTROLLED  
WITHIN DIM F.

DIM	INCHES		MILLIMETERS	
	MIN	MAX	MIN	MAX
A	0.330	0.350	8.38	8.89
B	0.130	0.145	3.30	3.68
D	0.037	0.043	0.94	1.09
F	—	0.050	—	1.27
K	1.000	1.250	25.40	31.75

STYLE 1:  
PIN 1. ANODE  
2. CATHODE

CASE 17-02  
PLASTIC

(Refer to Section 10 of the TVS/Zener Data Book (DL150/D) for Surface Mount, Thermal Data and Footprint Information.)

## P6KE6.8A Series

**ON Semiconductor** and  are trademarks of Semiconductor Components Industries, LLC (SCILLC). SCILLC reserves the right to make changes without further notice to any products herein. SCILLC makes no warranty, representation or guarantee regarding the suitability of its products for any particular purpose, nor does SCILLC assume any liability arising out of the application or use of any product or circuit, and specifically disclaims any and all liability, including without limitation special, consequential or incidental damages. "Typical" parameters which may be provided in SCILLC data sheets and/or specifications can and do vary in different applications and actual performance may vary over time. All operating parameters, including "Typicals" must be validated for each customer application by customer's technical experts. SCILLC does not convey any license under its patent rights nor the rights of others. SCILLC products are not designed, intended, or authorized for use as components in systems intended for surgical implant into the body, or other applications intended to support or sustain life, or for any other application in which the failure of the SCILLC product could create a situation where personal injury or death may occur. Should Buyer purchase or use SCILLC products for any such unintended or unauthorized application, Buyer shall indemnify and hold SCILLC and its officers, employees, subsidiaries, affiliates, and distributors harmless against all claims, costs, damages, and expenses, and reasonable attorney fees arising out of, directly or indirectly, any claim of personal injury or death associated with such unintended or unauthorized use, even if such claim alleges that SCILLC was negligent regarding the design or manufacture of the part. SCILLC is an Equal Opportunity/Affirmative Action Employer.

### PUBLICATION ORDERING INFORMATION

#### North America Literature Fulfillment:

Literature Distribution Center for ON Semiconductor  
P.O. Box 5163, Denver, Colorado 80217 USA  
**Phone:** 303-675-2175 or 800-344-3860 Toll Free USA/Canada  
**Fax:** 303-675-2176 or 800-344-3867 Toll Free USA/Canada  
**Email:** ONlit@hibbertco.com

**N. American Technical Support:** 800-282-9855 Toll Free USA/Canada

#### EUROPE: LDC for ON Semiconductor – European Support

**German Phone:** (+1) 303-308-7140 (M-F 2:30pm to 5:00pm Munich Time)  
**Email:** ONlit-german@hibbertco.com  
**French Phone:** (+1) 303-308-7141 (M-F 2:30pm to 5:00pm Toulouse Time)  
**Email:** ONlit-french@hibbertco.com  
**English Phone:** (+1) 303-308-7142 (M-F 1:30pm to 5:00pm UK Time)  
**Email:** ONlit@hibbertco.com

#### ASIA/PACIFIC: LDC for ON Semiconductor – Asia Support

**Phone:** 303-675-2121 (Tue-Fri 9:00am to 1:00pm, Hong Kong Time)  
Toll Free from Hong Kong 800-4422-3781  
**Email:** ONlit-asia@hibbertco.com

#### JAPAN: ON Semiconductor, Japan Customer Focus Center

4-32-1 Nishi-Gotanda, Shinagawa-ku, Tokyo, Japan 141-8549  
**Phone:** 81-3-5487-8345  
**Email:** r14153@onsemi.com

**Fax Response Line:** 303-675-2167  
800-344-3810 Toll Free USA/Canada

**ON Semiconductor Website:** <http://onsemi.com>

For additional information, please contact your local Sales Representative.