

**APPLICATIONS**

- Inverse, Parallel Or Series Connected Diode
- Power Supplies
- High Frequency Applications

**FEATURES**

- Glass Passivation
- High Voltage Capability
- Fast Recovery Characteristics

**KEY PARAMETERS**

$V_{RRM}$	<b>1200V</b>
$I_{F(AV)}$	<b>40A</b>
$I_{FSM}$	<b>400A</b>
$Q_r$	<b>10<math>\mu</math>C</b>
$t_{rr}$	<b>0.2ns</b>

**VOLTAGE RATINGS**

Type Number	Repetitive Peak Reverse Voltage $V_{RRM}$ V	Conditions
MF35 - 1200	1200	$V_{RSM} = V_{RRM} + 100V$
MF35 - 1000	1000	
MF35 - 800	800	
MF35 - 600	600	

Lower voltage grades available.  
For stud anode add suffix 'R' to type number. e.g. MF35-1200R.

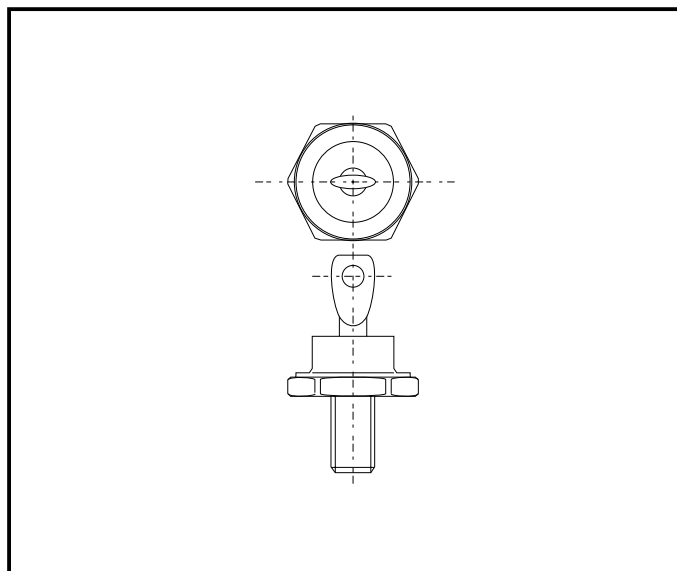

Outline type code: DO5.  
See Package Details for further information.

**CURRENT RATINGS**

Symbol	Parameter	Conditions	Max.	Units
$I_{F(AV)}$	Mean forward current	Half sine wave resistive load, $T_{case} = 65^{\circ}C$	40	A
$I_{F(RMS)}$	RMS value	$T_{case} = 65^{\circ}C$	63	A
$I_F$	Continuous (direct) forward current	$T_{case} = 65^{\circ}C$	50	A

## MF35

### SURGE RATINGS

Symbol	Parameter	Conditions	Max.	Units
$I_{FSM}$	Surge (non-repetitive) forward current	10ms half sine; with $V_{RRM} \leq 10V$ , $T_j = 125^\circ C$	400	A
$I^2t$	$I^2t$ for fusing	10ms half sine; $T_j = 125^\circ C$	800	A <sup>2</sup> s

### THERMAL AND MECHANICAL DATA

Symbol	Parameter	Conditions	Min.	Max.	Units
$R_{th(j-c)}$	Thermal resistance - junction to case	dc	-	0.8	°C/W
$R_{th(c-h)}$	Thermal resistance - case to heatsink	Mounting torque 3.5Nm with mounting compound	-	0.2	°C/W
$T_{vj}$	Virtual junction temperature	Forward (conducting)	-	125	°C
		Reverse (blocking)	-	125	°C
$T_{stg}$	Storage temperature range		-55	125	°C
-	Mounting torque		3.2	3.8	Nm

### CHARACTERISTICS

Symbol	Parameter	Conditions	Typ.	Max.	Units
$V_{FM}$	Forward voltage	At 120A peak, $T_{case} = 25^\circ C$	-	2.0	V
$I_{RM}$	Peak reverse current	At $V_{RRM}$ , $T_{case} = 100^\circ C$	-	5	mA
$t_{rr}$	Reverse recovery time	$I_F = 1A$ , $di_{RR}/dt = 25A/\mu s$ , $T_{case} = 25^\circ C$ , $V_R = 100V$	-	200	ns
$Q_R$	Recovered charge	$I_F = 50A$ , $di_{RR}/dt = 50A/\mu s$ , $T_{case} = 25^\circ C$ , $V_R = 100V$	-	10	$\mu C$
$V_{TO}$	Threshold voltage	At $T_{vj} = 125^\circ C$	-	1.2	V
$r_T$	Slope resistance	At $T_{vj} = 125^\circ C$	-	7.0	m $\Omega$

CURVES

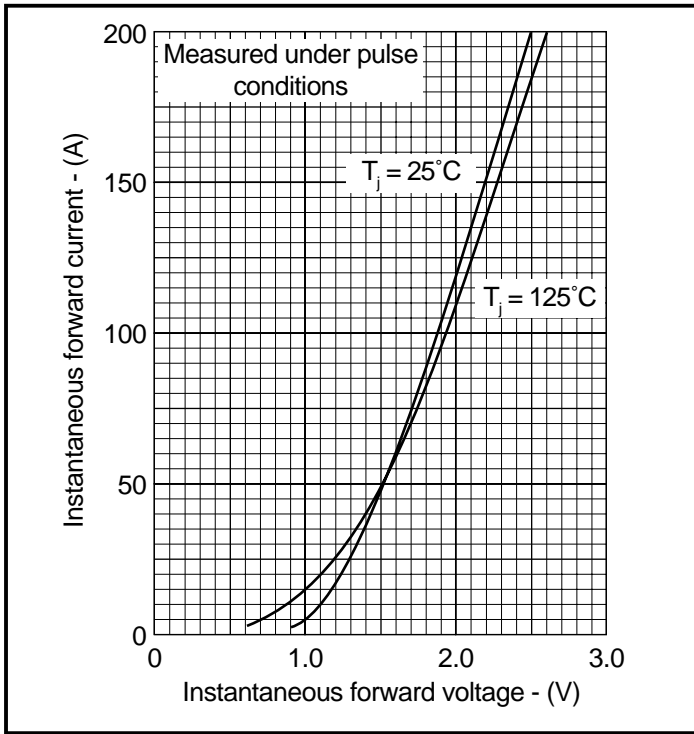

Fig.1 Maximum (limit) forward characteristics

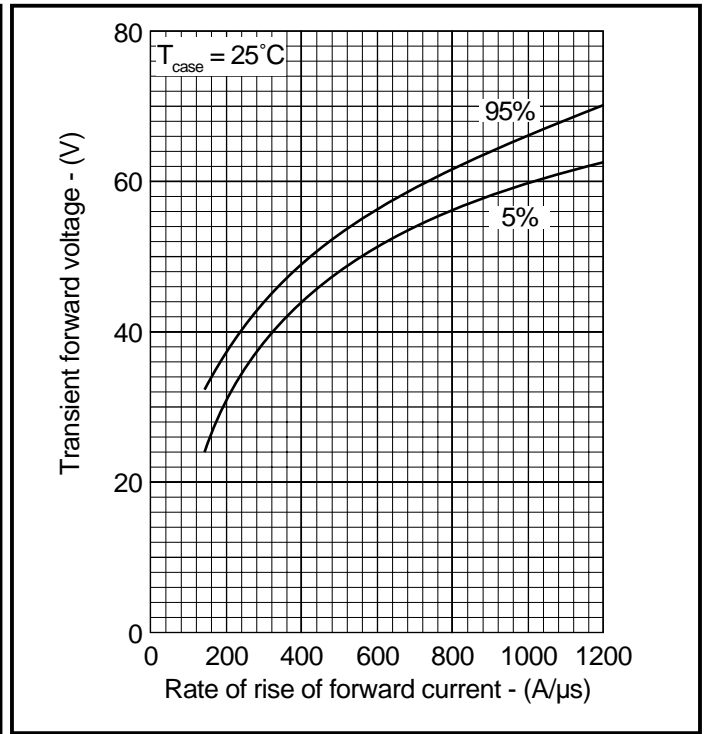

Fig.2 Forward recovery voltage vs rate of rise of forward voltage

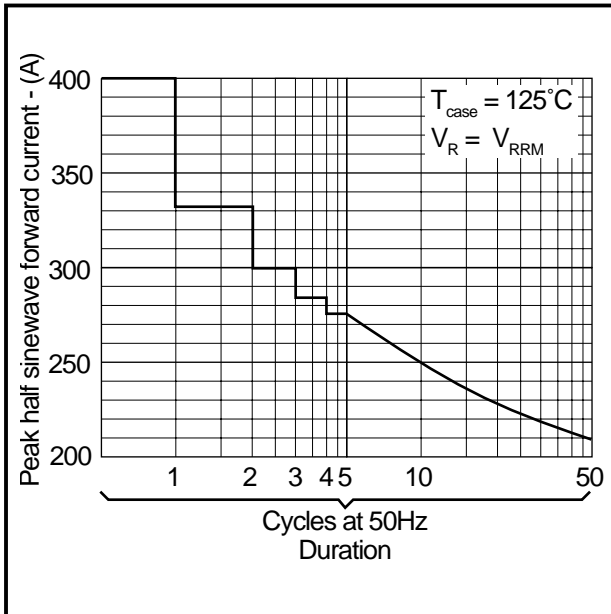

Fig.3 Surge (non-repetitive) forward current vs time

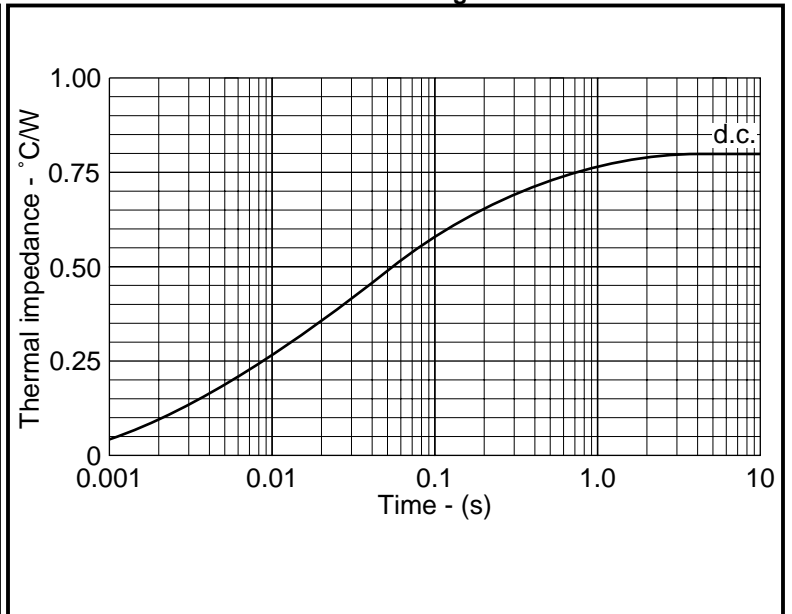

Fig.4 Maximum transient thermal impedance

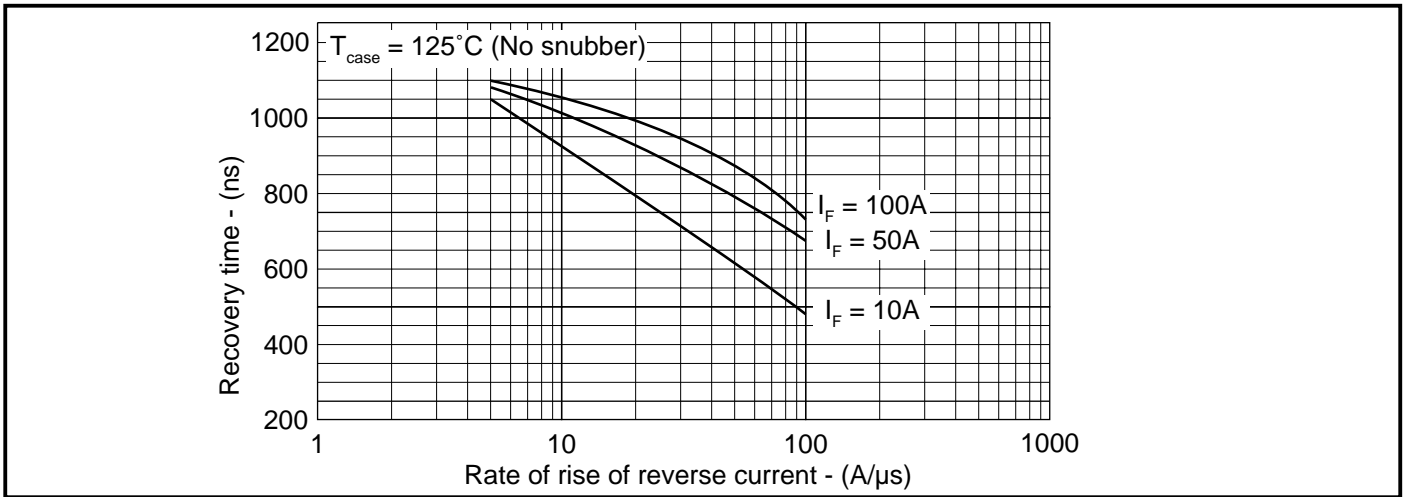

Fig.5 Recovery time vs  $di_R/dt$

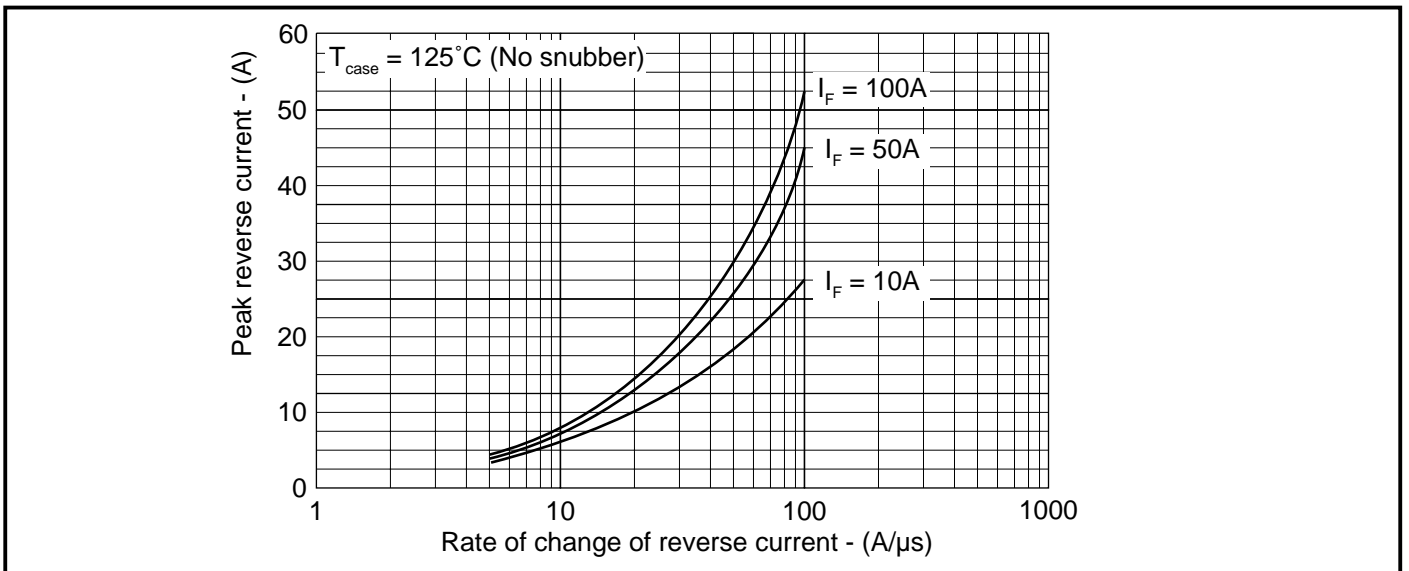

Fig.6 Peak reverse current vs  $di_R/dt$

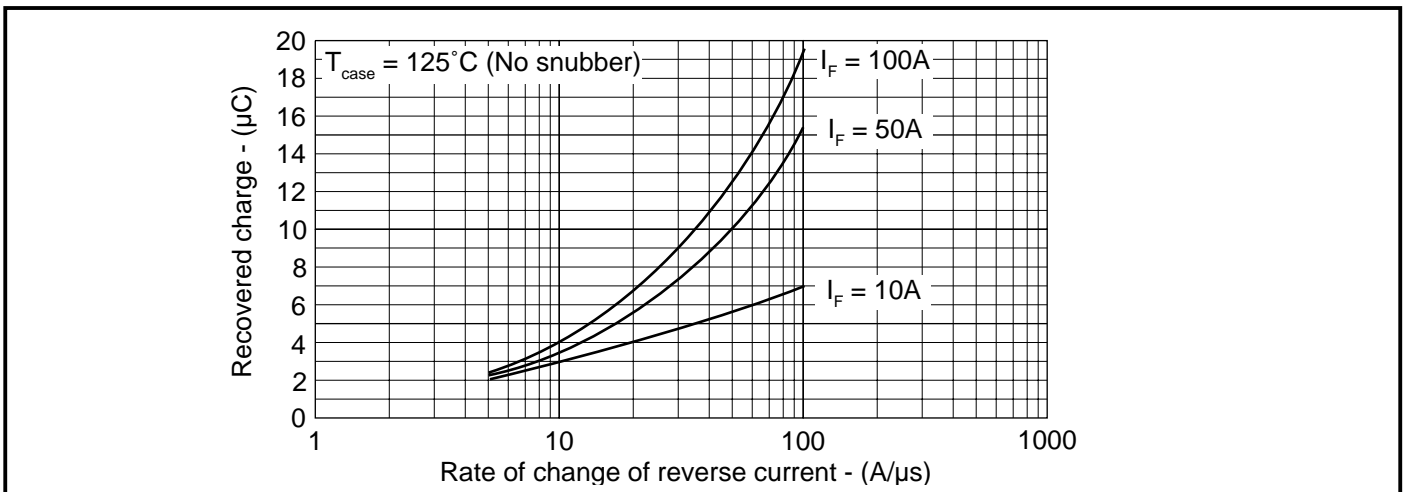

Fig.7 Recovered charge vs  $di_R/dt$

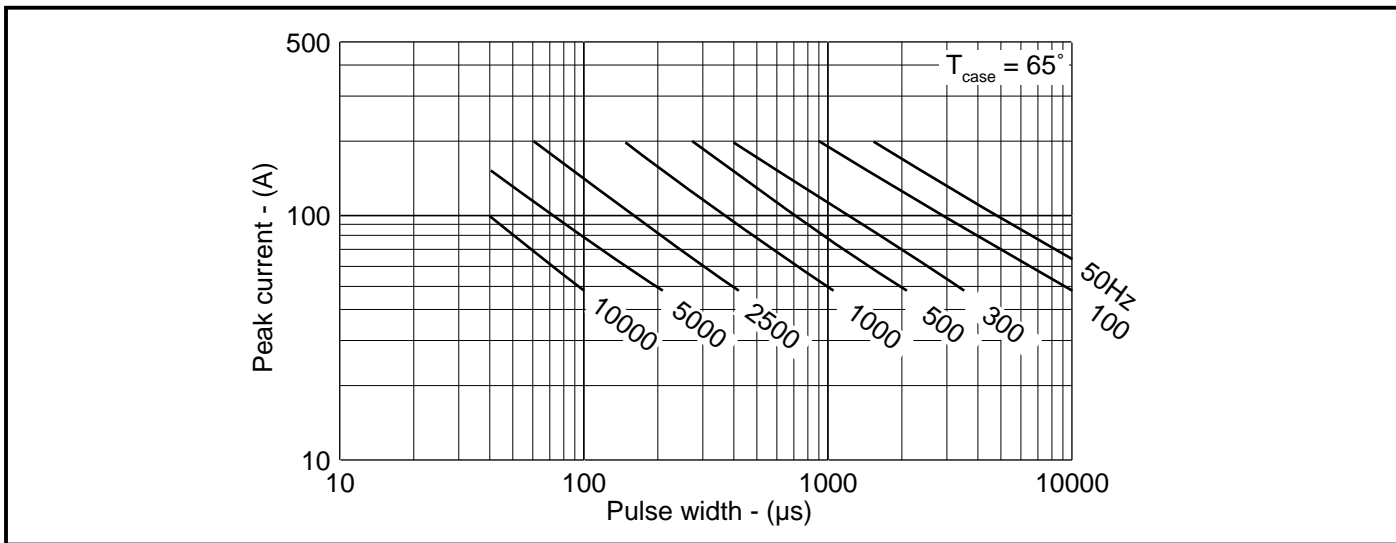

Fig.8 Frequency curves - square waveform

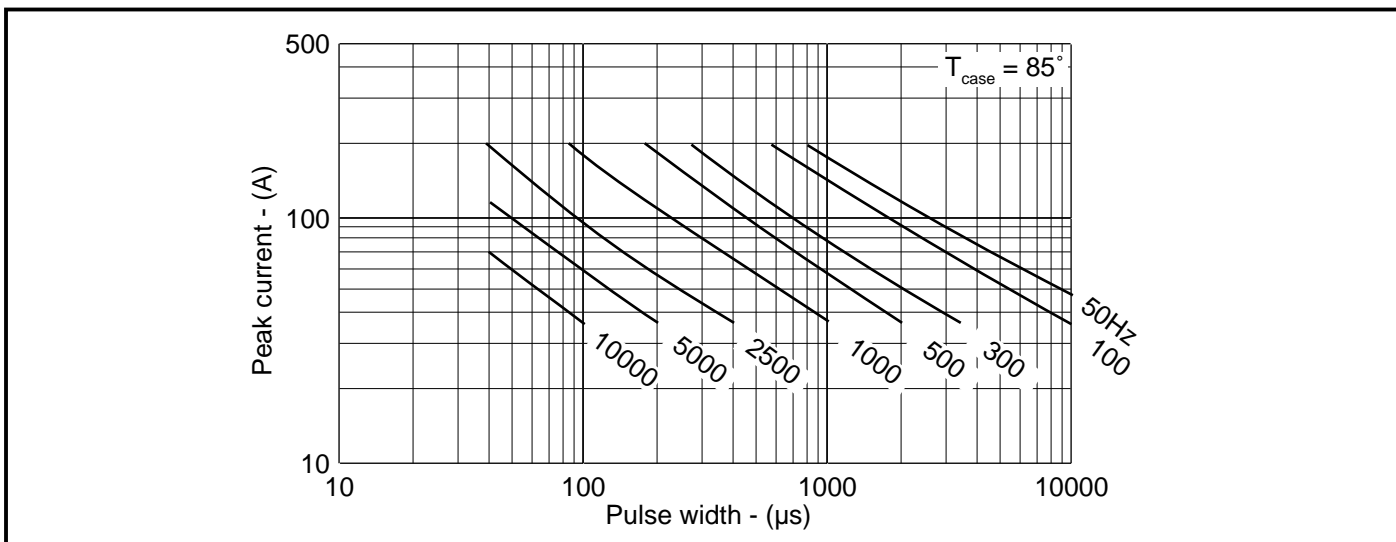

Fig.9 Frequency curves - square waveform

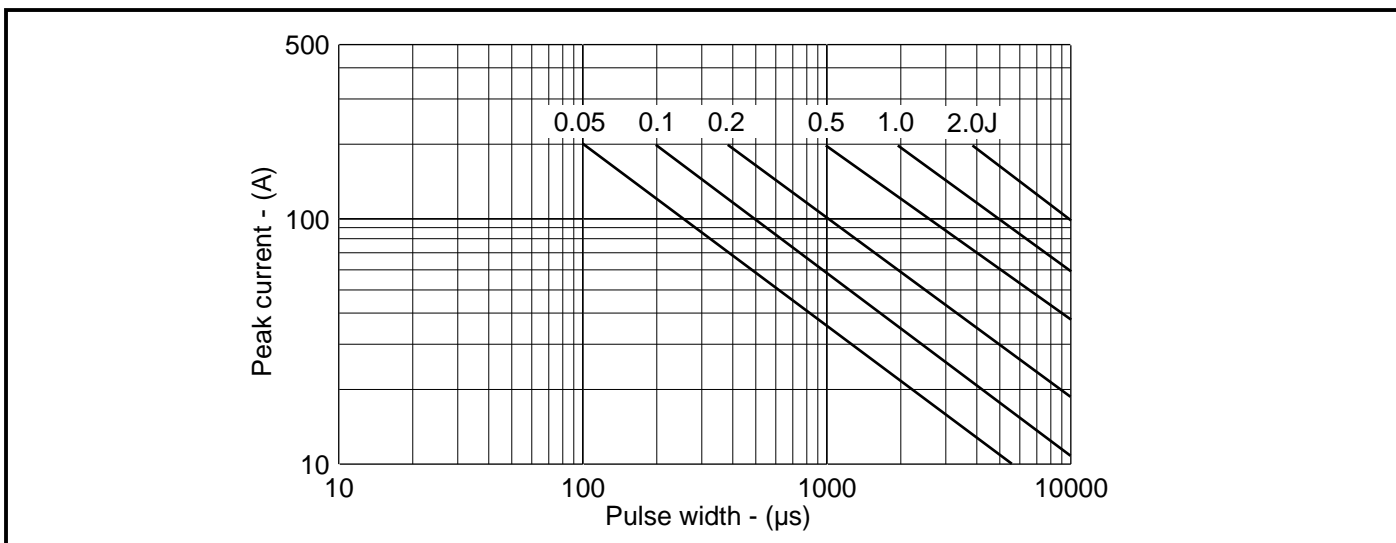

Fig.10 Energy per pulse - square waveform

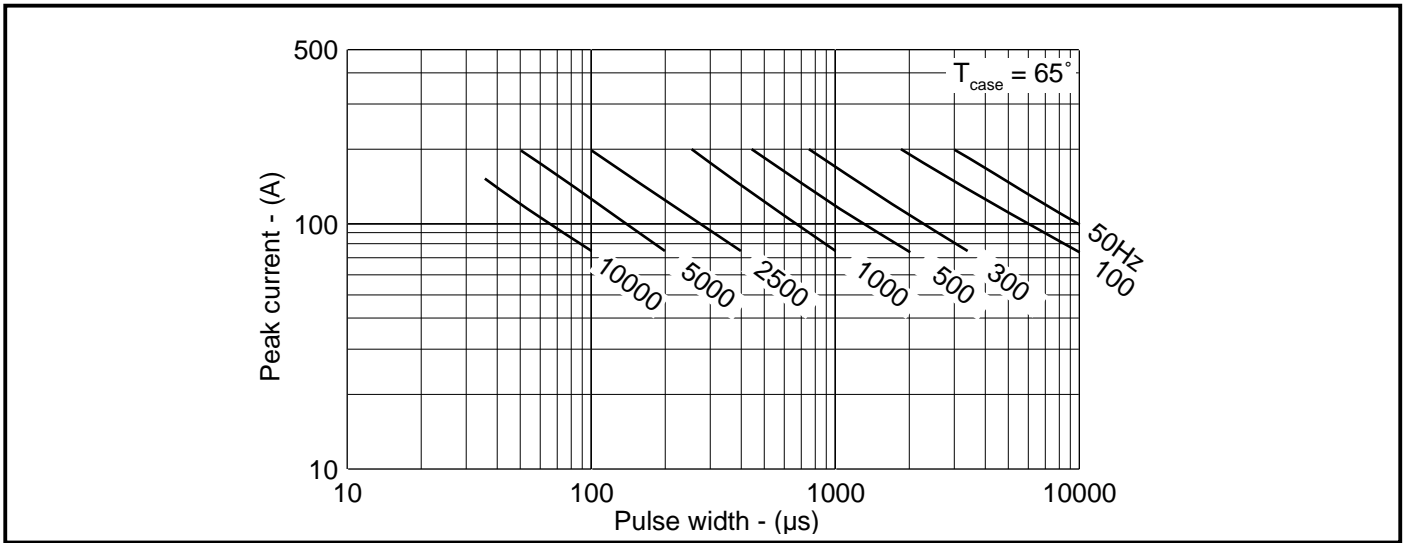

Fig.11 Frequency curves - sine waveform

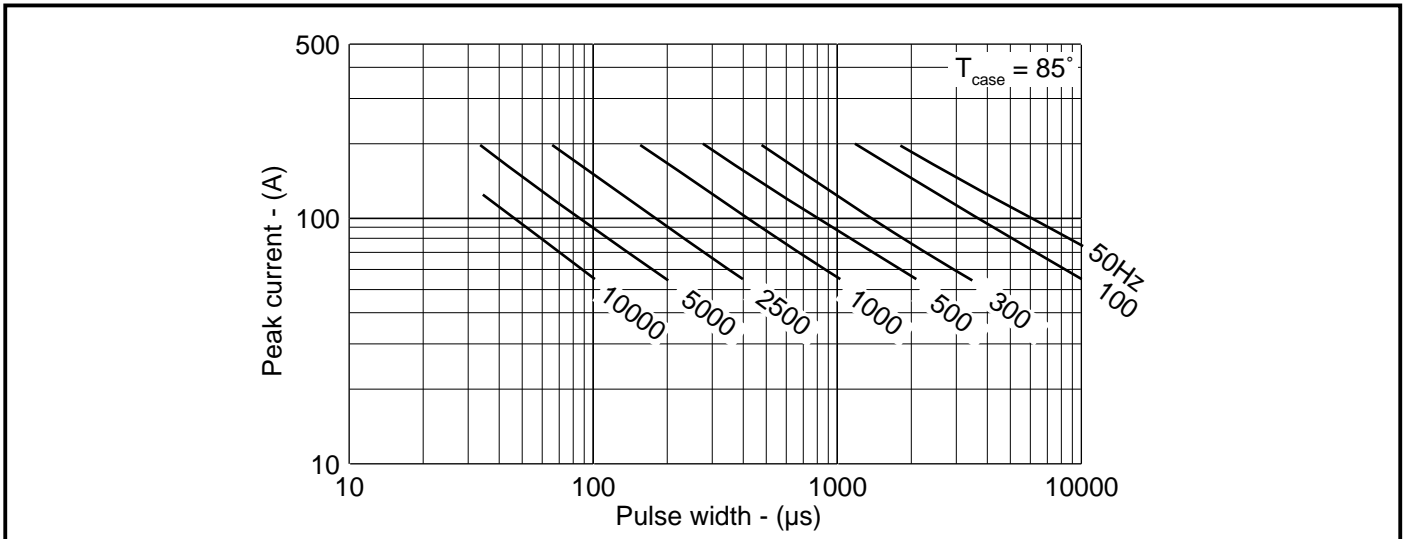

Fig.12 Frequency curves - sine waveform

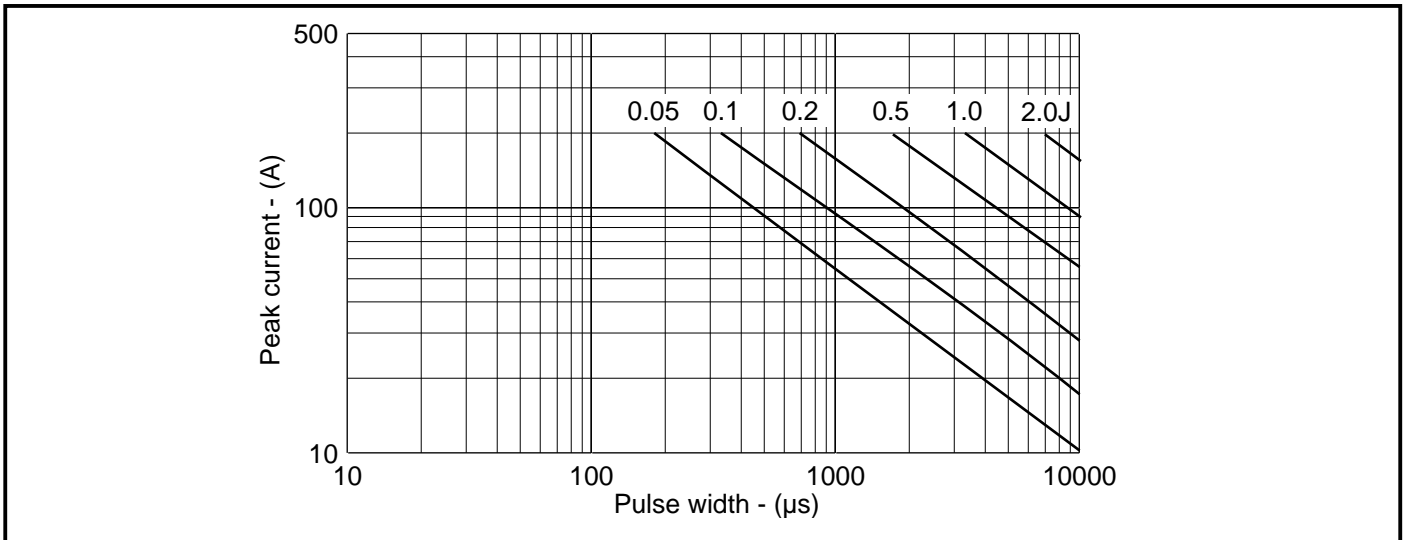
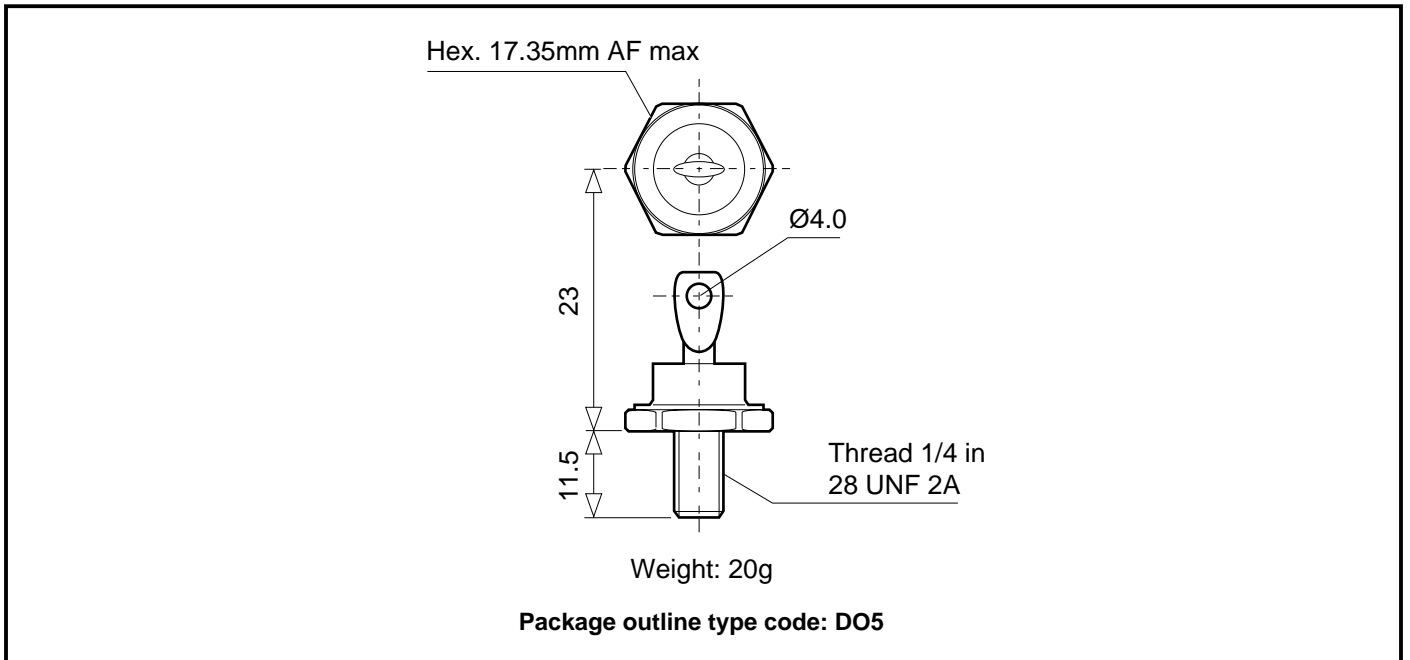

Fig.13 Energy per pulse - sine waveform

**PACKAGE DETAILS**

For further package information, please contact Customer Services. All dimensions in mm, unless stated otherwise.  
DO NOT SCALE.



## POWER ASSEMBLY CAPABILITY

The Power Assembly group was set up to provide a support service for those customers requiring more than the basic semiconductor, and has developed a flexible range of heatsink and clamping systems in line with advances in device voltages and current capability of our semiconductors.

We offer an extensive range of air and liquid cooled assemblies covering the full range of circuit designs in general use today. The Assembly group offers high quality engineering support dedicated to designing new units to satisfy the growing needs of our customers.

Using the latest CAD methods our team of design and applications engineers aim to provide the Power Assembly Complete Solution (PACs).

## HEATSINKS

The Power Assembly group has its own proprietary range of extruded aluminium heatsinks which have been designed to optimise the performance of Dynex semiconductors. Data with respect to air natural, forced air and liquid cooling (with flow rates) is available on request.

For further information on device clamps, heatsinks and assemblies, please contact your nearest sales representative or Customer Services.



<http://www.dynexsemi.com>

**e-mail: [power\\_solutions@dynexsemi.com](mailto:power_solutions@dynexsemi.com)**

HEADQUARTERS OPERATIONS  
**DYNEX SEMICONDUCTOR LTD**  
Doddington Road, Lincoln.  
Lincolnshire. LN6 3LF. United Kingdom.  
Tel: +44-(0)1522-500500  
Fax: +44-(0)1522-500550

CUSTOMER SERVICE  
Tel: +44 (0)1522 502753 / 502901. Fax: +44 (0)1522 500020

SALES OFFICES  
**Benelux, Italy & Switzerland:** Tel: +33 (0)1 64 66 42 17. Fax: +33 (0)1 64 66 42 19.  
**France:** Tel: +33 (0)2 47 55 75 52. Fax: +33 (0)2 47 55 75 59.  
**Germany, Northern Europe, Spain & Rest Of World:** Tel: +44 (0)1522 502753 / 502901.  
Fax: +44 (0)1522 500020  
**North America:** Tel: (613) 723-7035. Fax: (613) 723-1518. Toll Free: 1.888.33.DYNEX (39639) /  
Tel: (949) 733-3005. Fax: (949) 733-2986.

These offices are supported by Representatives and Distributors in many countries world-wide.  
© Dynex Semiconductor 2002 TECHNICAL DOCUMENTATION – NOT FOR RESALE. PRODUCED IN UNITED KINGDOM

### Datasheet Annotations:

Dynex Semiconductor annotate datasheets in the top right hand corner of the front page, to indicate product status. The annotations are as follows:-

**Target Information:** This is the most tentative form of information and represents a very preliminary specification. No actual design work on the product has been started.

**Preliminary Information:** The product is in design and development. The datasheet represents the product as it is understood but details may change.

**Advance Information:** The product design is complete and final characterisation for volume production is well in hand.

**No Annotation:** The product parameters are fixed and the product is available to datasheet specification.

This publication is issued to provide information only which (unless agreed by the Company in writing) may not be used, applied or reproduced for any purpose nor form part of any order or contract nor to be regarded as a representation relating to the products or services concerned. No warranty or guarantee express or implied is made regarding the capability, performance or suitability of any product or service. The Company reserves the right to alter without prior notice the specification, design or price of any product or service. Information concerning possible methods of use is provided as a guide only and does not constitute any guarantee that such methods of use will be satisfactory in a specific piece of equipment. It is the user's responsibility to fully determine the performance and suitability of any equipment using such information and to ensure that any publication or data used is up to date and has not been superseded. These products are not suitable for use in any medical products whose failure to perform may result in significant injury or death to the user. All products and materials are sold and services provided subject to the Company's conditions of sale, which are available on request.

All brand names and product names used in this publication are trademarks, registered trademarks or trade names of their respective owners.