

Current Regulator Diodes

CR160 CR220 CR300 CR390
CR180 CR240 CR330 CR430
CR200 CR270 CR360 CR470

Product Summary

Part Number	Typ I_F (mA)	Min P_{OV} (V)	Part Number	Typ I_F (mA)	Min P_{OV} (V)
CR160	1.60	100	CR300	3.00	100
CR180	1.80	100	CR330	3.30	100
CR200	2.00	100	CR360	3.60	100
CR220	2.20	100	CR390	3.90	100
CR240	2.40	100	CR430	4.30	100
CR270	2.70	100	CR470	4.70	100

For applications information see AN103.

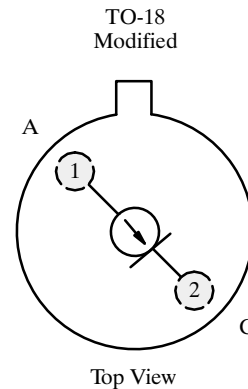

Features

- Two-Lead Hermetic Package
- Guaranteed Tight $\pm 10\%$ Tolerance
- Operation from 1 V (CR160) to 100 V
- Excellent Temperature Stability

Benefits

- Simple Series Circuitry, No Separate Voltage Source
- Tighter Guaranteed Circuit Performance
- Excellent Performance in Low-Voltage/Battery Circuits and High-Voltage Spike Protection
- High Circuit Stability vs. Temperature

Applications

- Constant-Current Supply
- Current-Limiting
- Timing Circuits

Description

The CR160 series is a family of $\pm 10\%$ range current regulators designed for demanding applications in test equipment and instrumentation. These devices combine a JFET with an integrated resistor to produce a single two-leaded device which is extremely simple to operate. With nominal current ranges from 1.60 mA

to 4.70 mA, this series will meet a wide array of design requirements.

The TO-206AA hermetically sealed package is available with military processing per MIL-S-19500 (see Military Information).

Schematic Diagram

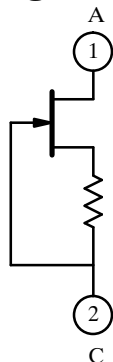

Applications

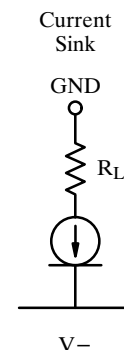
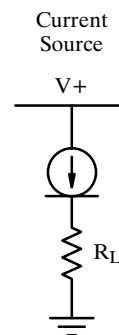

CR160 Series

Absolute Maximum Ratings

Peak Operating Voltage 100 V
 Reverse Current 50 mA
 Thermal Resistance (θ_{JC}) 100°C/W
 Storage Temperature -55 to 200°C

Power Dissipation^a 300 mW

Notes:

a. Derate 2.4 mW/°C above 25°C

Specifications^a

Parameter	Symbol	Test Conditions	Limits			Unit
			Min	Typ ^b	Max	
Peak Operating Voltage ^c	P_{OV}	$I_F = 1.1 I_{F(max)}$	100	175		V
Reverse Voltage	V_R	$I_R = 1 \text{ mA}$		0.8		
Capacitance	C_F	$V_F = 25 \text{ V}, f = 1 \text{ MHz}$		6		pF

Part Number	Regulator Current ^d (I_F)			Dynamic Impedance ^e (Z_d)		Knee Impedance (Z_k)		Limiting Voltage ^f (V_L)		Temperature Coefficient (θ_I)
	Min	Nom	Max	Min	Typ ^b	Min	Typ ^b	Max	Typ ^b	ppm/°C
	$V_F = 25 \text{ V}$			$V_F = 25 \text{ V}$		$V_F = 6 \text{ V}$		$I_F = 0.8 I_{F(min)}$		$V_F = 25 \text{ V}$ $0^\circ\text{C} \leq T_A \leq 100^\circ\text{C}$
	mA			M Ω		M Ω		V		
CR160	1.440	1.60	1.760	0.475	1.10	0.092	0.40	1.65	0.70	1000
CR180	1.620	1.80	1.980	0.420	1.00	0.074	0.34	1.75	0.75	650
CR200	1.800	2.00	2.200	0.395	0.90	0.061	0.28	1.85	0.80	300
CR220	1.980	2.20	2.420	0.370	0.83	0.052	0.25	1.95	0.85	100
CR240	2.160	2.40	2.640	0.345	0.76	0.044	0.22	2.00	0.90	0
CR270	2.430	2.70	2.970	0.320	0.70	0.035	0.19	2.15	0.95	-200
CR300	2.700	3.00	3.300	0.300	0.65	0.029	0.16	2.25	1.00	-400
CR330	2.970	3.30	3.630	0.280	0.60	0.024	0.14	2.35	1.05	-550
CR360	3.240	3.60	3.960	0.265	0.54	0.020	0.13	2.50	1.10	-730
CR390	3.510	3.90	4.290	0.255	0.47	0.017	0.12	2.60	1.17	-820
CR430	3.870	4.30	4.730	0.245	0.40	0.014	0.10	2.75	1.25	-1000
CR470	4.230	4.70	5.170	0.235	0.35	0.012	0.09	2.90	1.32	-1125

Notes:

- $T_A = 25^\circ\text{C}$ unless otherwise noted.
- Typical values are for DESIGN AID ONLY, not guaranteed nor subject to production testing.
- Peak voltage at which $I_F = 1.1 I_{F(max)}$.
- Pulse test—steady state currents may vary.
- Pulse test—steady state impedances may vary.
- Min V_F required to insure $I_F = 0.8 I_{F(min)}$.

Typical Characteristics

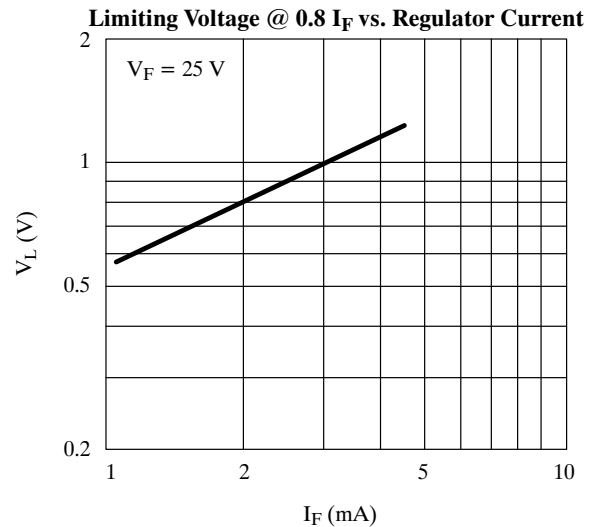
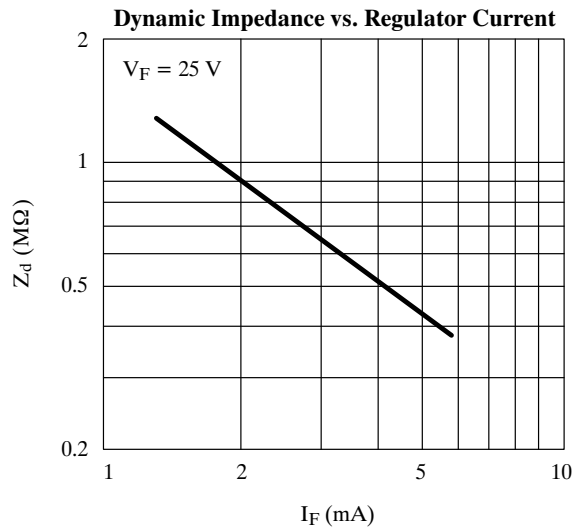
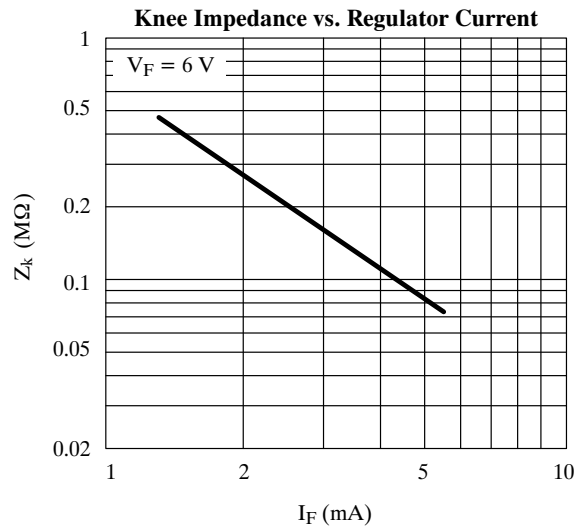
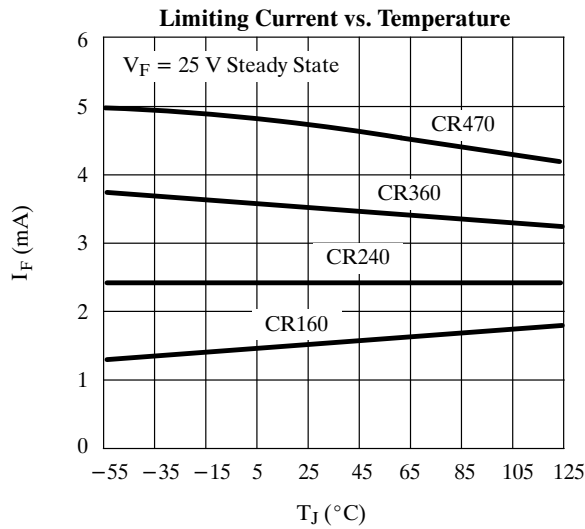
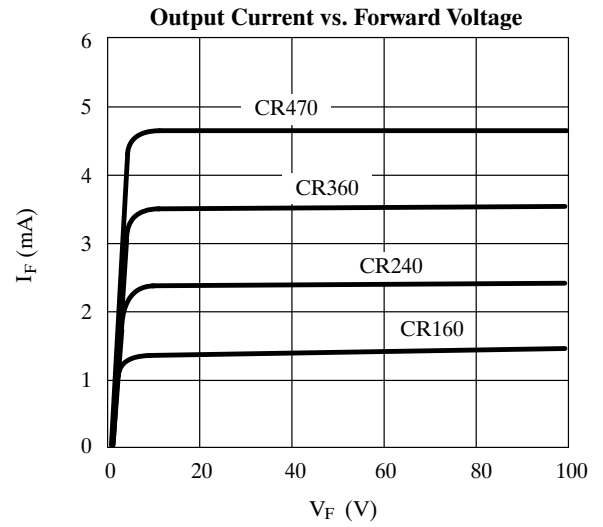
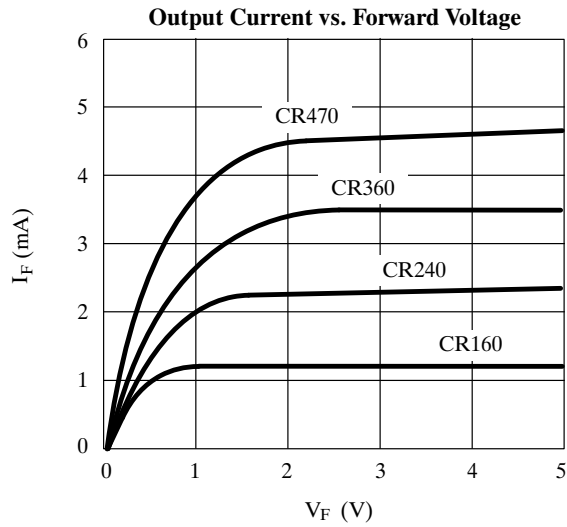

CR160 Series

Typical Characteristics (Cont'd)

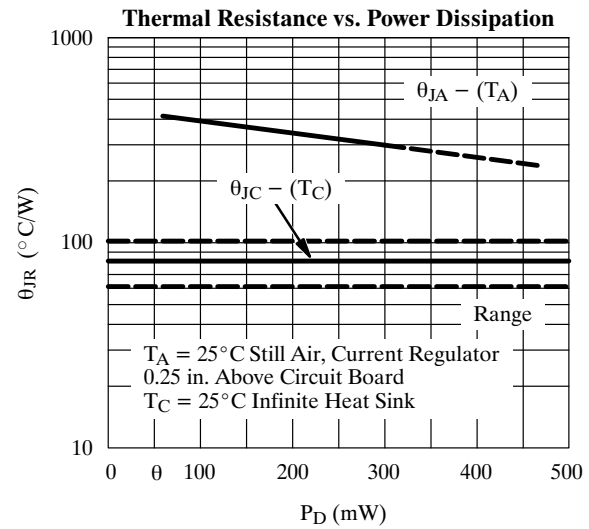
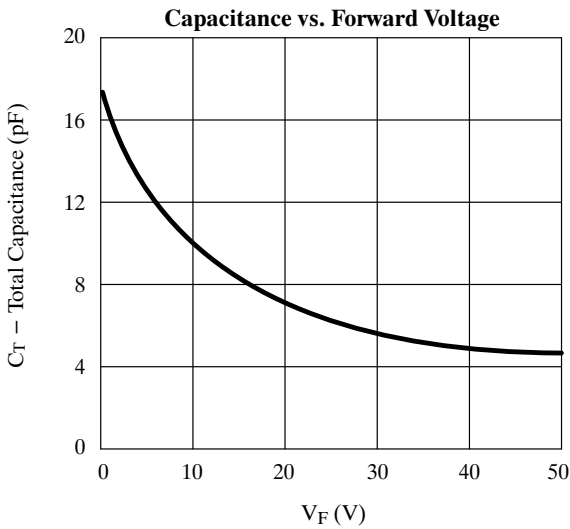
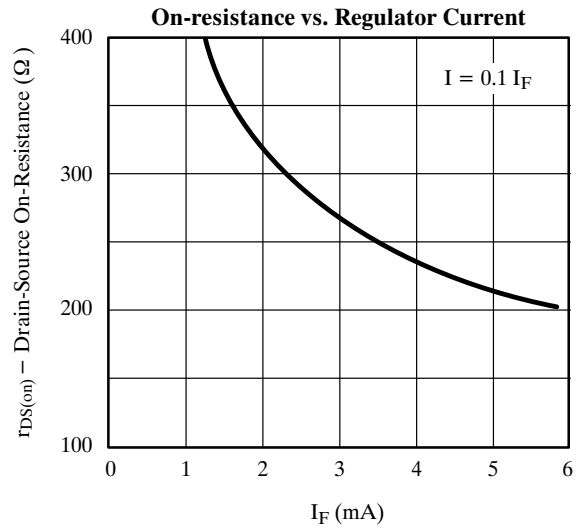
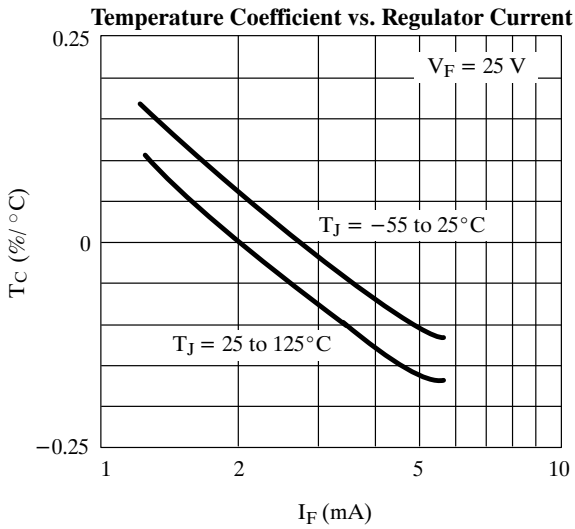

Current-Regulator Diode V-I Characteristic

