

FAST RECOVERY RECTIFIER DIODES

- VERY LOW REVERSE RECOVERY TIME
- VERY LOW SWITCHING LOSSES
- LOW NOISE TURN-OFF SWITCHING
- INSULATED: Capacitance 15pF

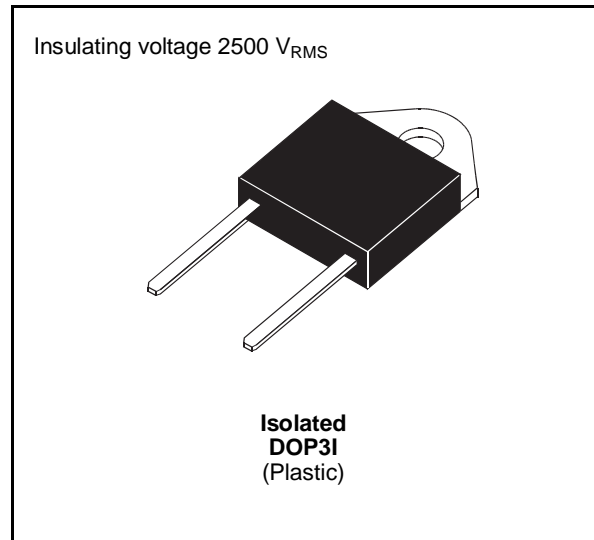

SUITABLE APPLICATIONS

- FREE WHEELING DIODE IN CONVERTERS AND MOTOR CONTROL CIRCUITS
- RECTIFIER IN S.M.P.S.

ABSOLUTE RATINGS (limiting values)

| Symbol | Parameter | | Value | Unit |
|------------------------------------|--|-------------------------------------|--------------------------------|------|
| I _{FRM} | Repetitive Peak Forward Current | t _p ≤ 10μs | 500 | A |
| I _{F (RMS)} | RMS Forward Current | | 50 | A |
| I _{F (AV)} | Average Forward Current | T _c = 60°C δ = 0.5 | 30 | A |
| I _{FSM} | Surge non Repetitive Forward Current | t _p = 10ms Sinusoidal | 350 | A |
| P | Power Dissipation | T _c = 60°C | 50 | W |
| T _{stg} T _j | Storage and Junction Temperature Range | | - 40 to + 150 - 40 to + 150 | °C |

| Symbol | Parameter | Value | Unit |
|------------------|-------------------------------------|-------|------|
| V _{RRM} | Repetitive Peak Reverse Voltage | 400 | V |
| V _{RSM} | Non Repetitive Peak Reverse Voltage | 440 | V |

THERMAL RESISTANCE

| Symbol | Parameter | Value | Unit |
|-------------------------|---------------|-------|------|
| R _{th (j - c)} | Junction-case | 1.8 | °C/W |

ELECTRICAL CHARACTERISTICS

STATIC CHARACTERISTICS

| Symbol | Test Conditions | | Min. | Typ. | Max. | Unit |
|--------|---------------------------|--------------------|------|------|------|---------------|
| I_R | $T_j = 25^\circ\text{C}$ | $V_R = V_{RRM}$ | | | 35 | μA |
| | $T_j = 100^\circ\text{C}$ | | | | 6 | mA |
| V_F | $T_j = 25^\circ\text{C}$ | $I_F = 30\text{A}$ | | | 1.5 | V |
| | $T_j = 100^\circ\text{C}$ | | | | 1.4 | |

RECOVERY CHARACTERISTICS

| Symbol | Test Conditions | | | Min. | Typ. | Max. | Unit |
|----------|--------------------------|---------------------|-------------------------------------|--------------------|-------------------------|------|-------------|
| t_{rr} | $T_j = 25^\circ\text{C}$ | $I_F = 1\text{A}$ | $di_F/dt = -15\text{A}/\mu\text{s}$ | $V_R = 30\text{V}$ | | 100 | ns |
| | | $I_F = 0.5\text{A}$ | $I_R = 1\text{A}$ | | $I_{rr} = 0.25\text{A}$ | | |

TURN-OFF SWITCHING CHARACTERISTICS (Without Series Inductance)

| Symbol | Test Conditions | | Min. | Typ. | Max. | Unit |
|-----------|--------------------------------------|--|------|------|------|-------------|
| t_{IRM} | $di_F/dt = -120\text{A}/\mu\text{s}$ | $V_{CC} = 200\text{V}$ $I_F = 30\text{A}$ $L_p \leq 0.05\mu\text{H}$ $T_j = 100^\circ\text{C}$ See figure 11 | | | 75 | ns |
| | $di_F/dt = -240\text{A}/\mu\text{s}$ | | | 50 | | |
| I_{RM} | $di_F/dt = -120\text{A}/\mu\text{s}$ | | | | 9 | A |
| | $di_F/dt = -240\text{A}/\mu\text{s}$ | | | 12 | | |

TURN-OFF OVERVOLTAGE COEFFICIENT (With Series Inductance)

| Symbol | Test Conditions | | | Min. | Typ. | Max. | Unit |
|-----------------------------|-------------------------------------|-----------------------|----------------------------|------|------|------|------|
| $C = \frac{V_{RP}}{V_{CC}}$ | $T_j = 100^\circ\text{C}$ | $V_{CC} = 60\text{V}$ | $I_F = I_{F(AV)}$ See note | | 3.3 | | |
| | $di_F/dt = -30\text{A}/\mu\text{s}$ | $L_p = 1\mu\text{H}$ | See figure 12 | | | | |

To evaluate the conduction losses use the following equations:

$$V_F = 1.1 + 0.0095 I_F \quad P = 1.1 \times I_{F(AV)} + 0.0095 I_{F(RMS)}^2$$

Figure 1. Low frequency power losses versus average current

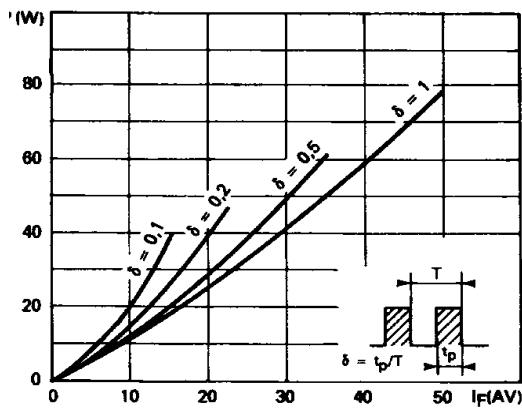

Figure 2. Peak current versus form factor

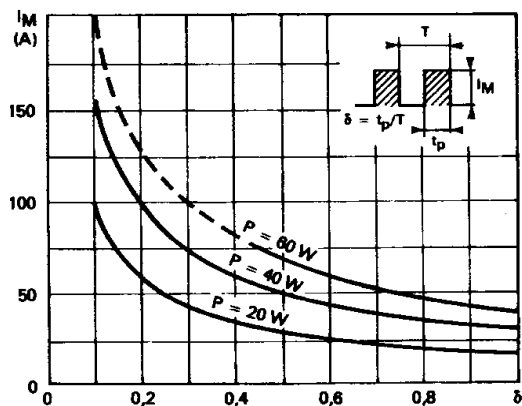

Figure 3. Non repetitive peak surge current versus overload duration

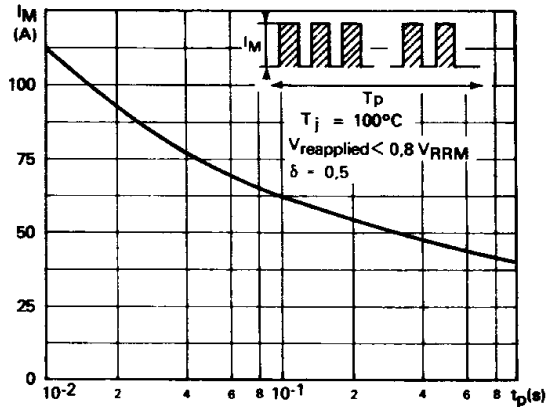

Figure 4. Thermal impedance versus pulse width

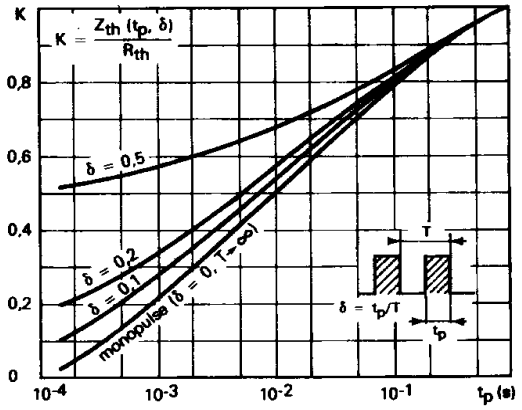

Figure 5. Voltage drop versus forward current

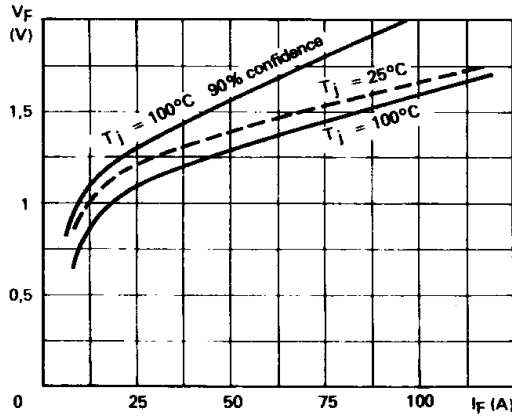

Figure 6. Recovery charge versus di_F/dt

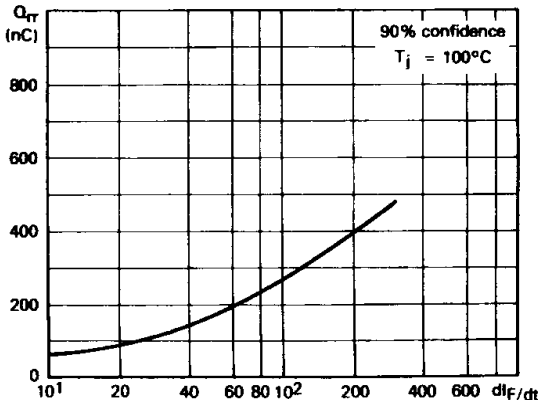

Figure 7. Recovery time versus di_F/dt

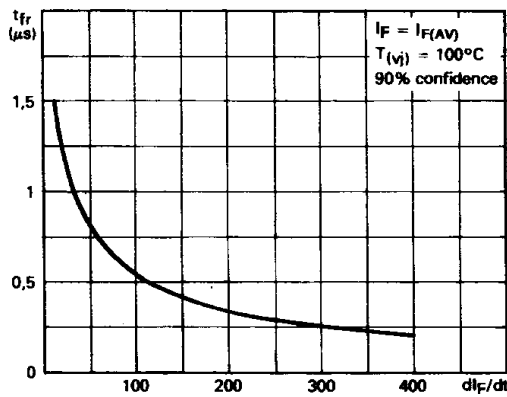

Figure 8. Peak reverse current versus di_F/dt

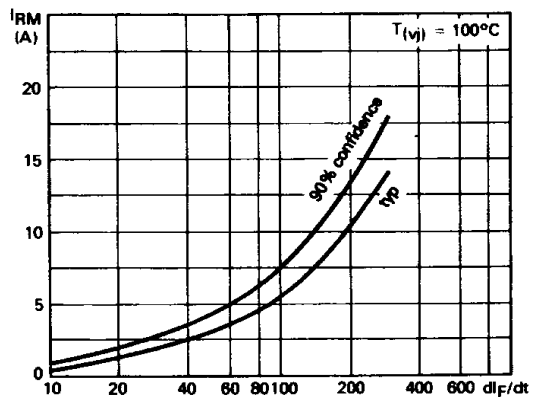

Figure 9. Peak forward voltage versus di_F/dt .

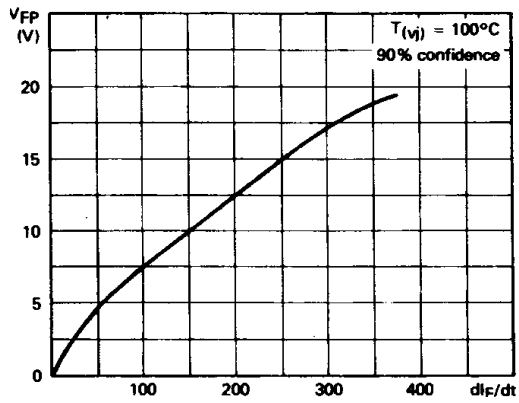

Figure 10. Dynamic parameters versus junction temperature.

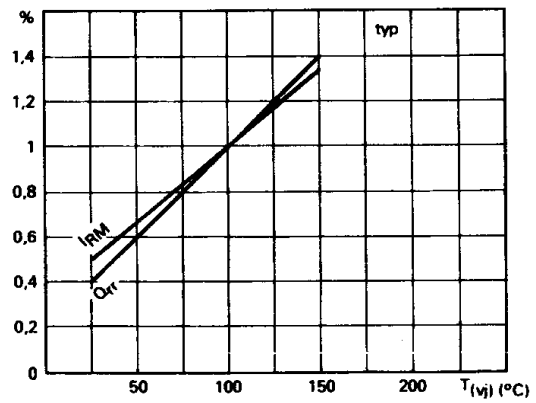

Figure 11. Turn-off switching characteristics (without series inductance).

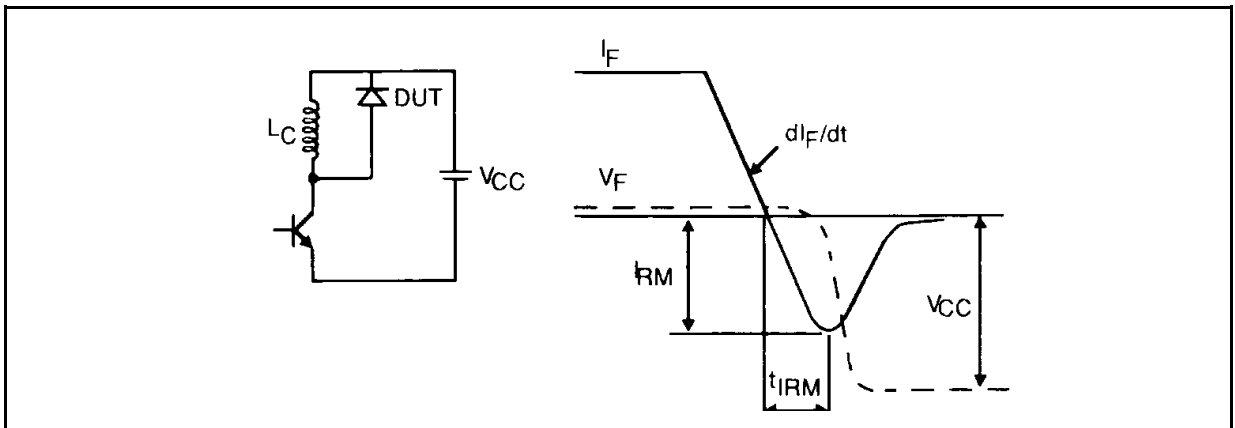
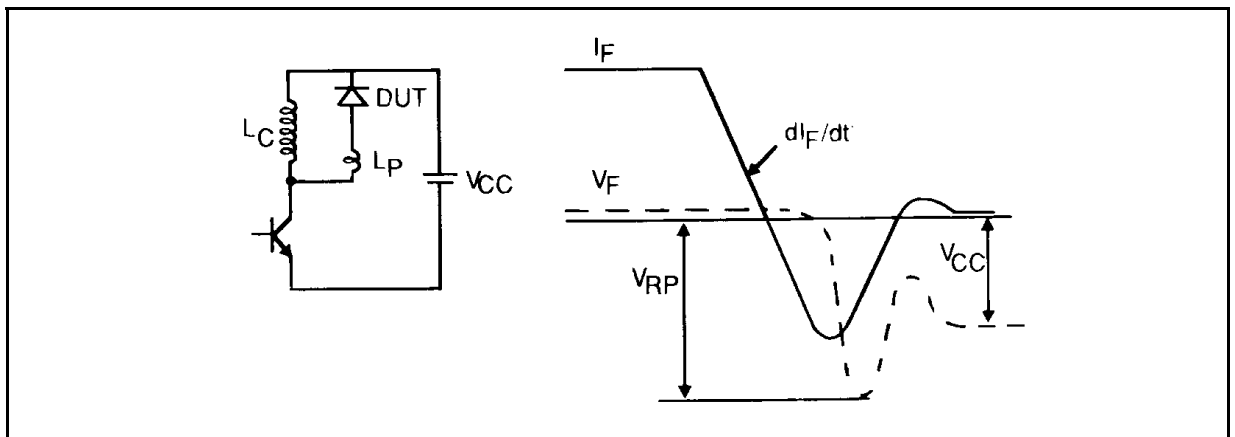
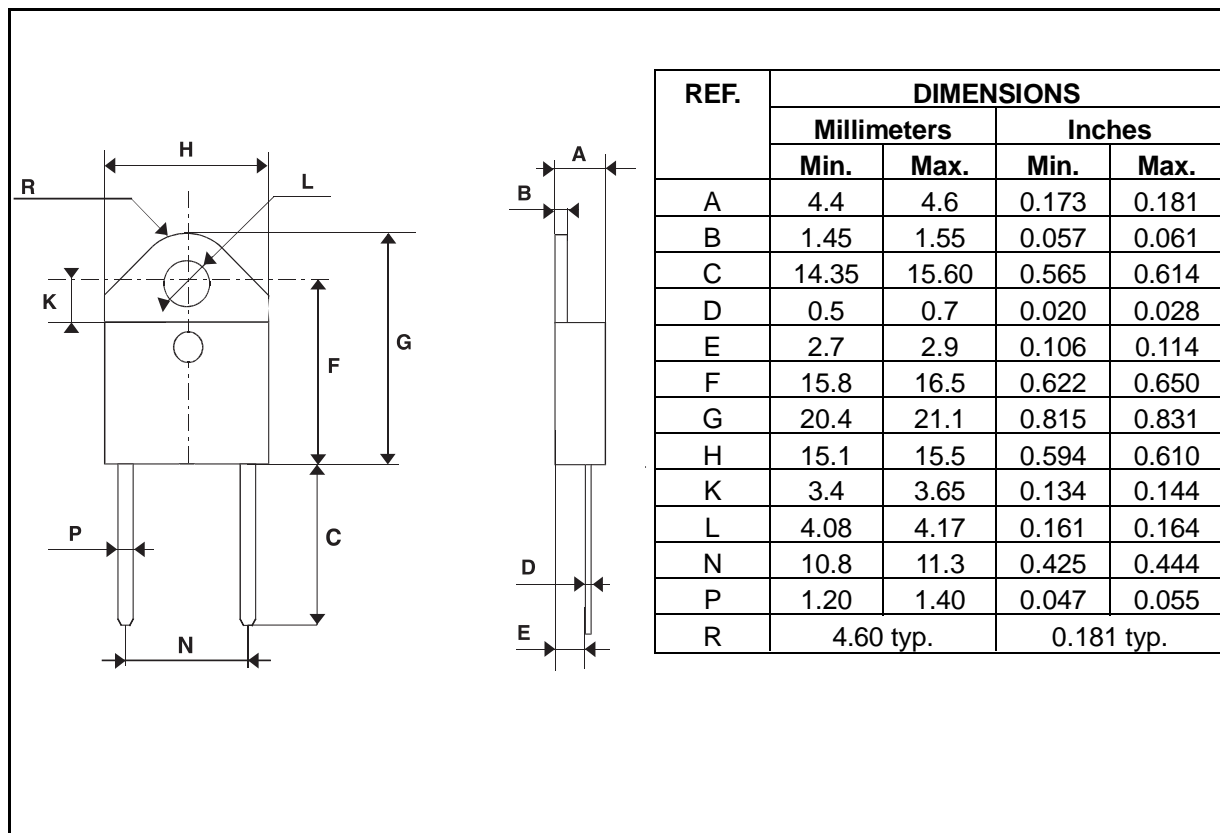

Figure 12. Turn-off switching characteristics (with series inductance)



PACKAGE MECHANICAL DATA :
Isolated DOP3I Plastic



- **Marking:** type number
- **Cooling method:** by conduction (method C)
- **Weight:** 4.52g
- **Recommended torque value:** 80cm. N
- **Maximum torque value:** 100cm. N

Information furnished is believed to be accurate and reliable. However, STMicroelectronics assumes no responsibility for the consequences of use of such information nor for any infringement of patents or other rights of third parties which may result from its use. No license is granted by implication or otherwise under any patent or patent rights of STMicroelectronics. Specifications mentioned in this publication are subject to change without notice. This publication supersedes and replaces all information previously supplied. STMicroelectronics products are not authorized for use as critical components in life support devices or systems without express written approval of STMicroelectronics.

The ST logo is a registered trademark of STMicroelectronics
© 1999 STMicroelectronics - Printed in Italy - All rights reserved.

STMicroelectronics GROUP OF COMPANIES
Australia - Brazil - China - Finland - France - Germany - Hong Kong - India - Italy - Japan - Malaysia
Malta - Morocco - Singapore - Spain - Sweden - Switzerland - United Kingdom - U.S.A.

<http://www.st.com>