

Ultra Fast Recovery Silicon Power Rectifier

Features

- Multiple diffusion
- Epitaxial – planar
- Ultra fast forward recovery time
- Ultra fast reverse recovery time
- Low reverse current
- Very good reverse current stability at high temperature
- Low thermal resistance

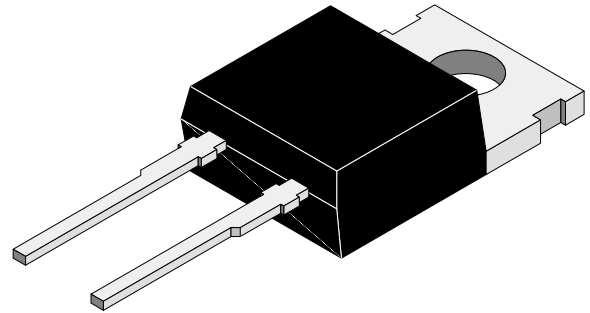

94 9537

Applications

Fast rectifiers in S.M.P.S
Freewheeling diodes and snubber diodes in motor control circuits

Absolute Maximum Ratings

$T_j = 25^\circ\text{C}$

| Parameter | Test Conditions | Type | Symbol | Value | Unit |
|--|---------------------|------------|-----------------|------------|------------------|
| Reverse voltage, repetitive peak reverse voltage | | BYT115/200 | $V_R = V_{RRM}$ | 200 | V |
| | | BYT115/400 | $V_R = V_{RRM}$ | 400 | V |
| Peak forward surge current | $t_p = 10\text{ms}$ | | I_{FSM} | 100 | A |
| Repetitive peak forward current | | | I_{FRM} | 30 | A |
| Average forward current | | | I_{FAV} | 15 | A |
| Junction temperature | | | T_j | 150 | $^\circ\text{C}$ |
| Storage temperature range | | | T_{stg} | -55...+150 | $^\circ\text{C}$ |

Maximum Thermal Resistance

$T_j = 25^\circ\text{C}$

| Parameter | Test Conditions | Symbol | Value | Unit |
|------------------|-----------------|------------|-------|------|
| Junction case | | R_{thJC} | 1.75 | K/W |
| Junction ambient | | R_{thJA} | 85 | K/W |

Characteristics

$T_j = 25^\circ\text{C}$

| Parameter | Test Conditions | Type | Symbol | Min | Typ | Max | Unit |
|--|---|------------|-----------|-----|-----|-----|---------------|
| Forward voltage | $I_F=15\text{A}$ | | V_F | | | 1.3 | V |
| | $I_F=15\text{A}, T_j=100^\circ\text{C}$ | | V_F | | | 1.2 | V |
| Reverse current | $V_R=V_{RRM}$ | | I_R | | | 2 | μA |
| | $V_R=V_{RRM}; T_j=100^\circ\text{C}$ | | I_R | | | 0.2 | mA |
| Forward recovery time | $I_F=15\text{A}, di_F/dt \leq 50\text{A}/\mu\text{s}$ | | t_{fr} | | 350 | | ns |
| Turn on transient peak voltage | | | V_{FP} | | | 4 | V |
| Reverse recovery characteristics, see Fig. 3 | $I_F=15\text{A}, di_F/dt \leq -150\text{A}/\mu\text{s}, V_{Batt}=200\text{V}$ | | I_{RM} | | 12 | | A |
| | | | t_{IRM} | | 75 | | ns |
| Reverse recovery time | $I_F=15\text{A}, di_F/dt \leq -150\text{A}/\mu\text{s}, V_{Batt}=200\text{V}$ | | t_{rr} | | 140 | | ns |
| | | BYT115/200 | t_{rr} | | | 35 | ns |
| | | BYT115/400 | t_{rr} | | | 50 | ns |

Typical Characteristics ($T_j = 25^\circ\text{C}$ unless otherwise specified)

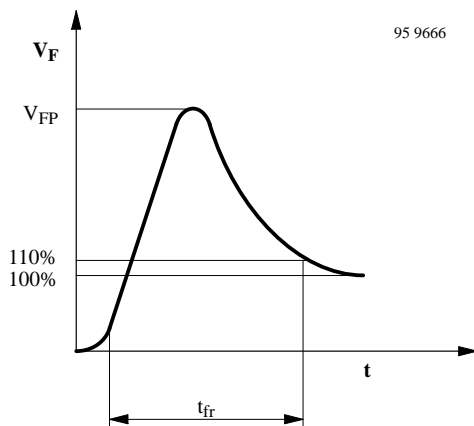

Figure 1. Turn on transient peak voltage

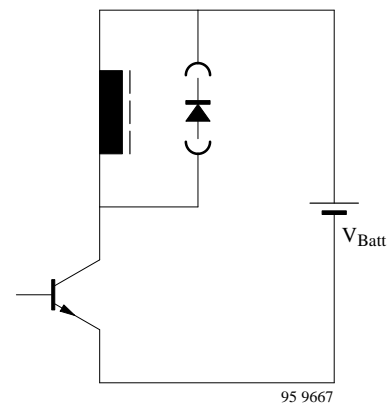

Figure 2. Test circuit

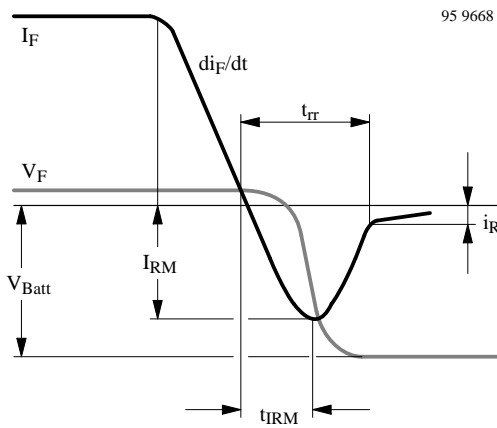

Figure 3. Turn off switching characteristic

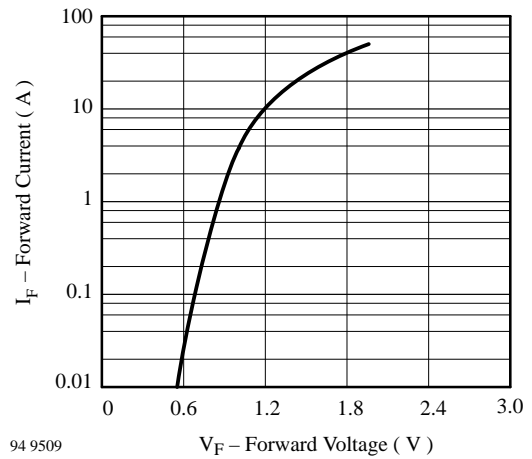

Figure 6. Forward Current vs. Forward Voltage

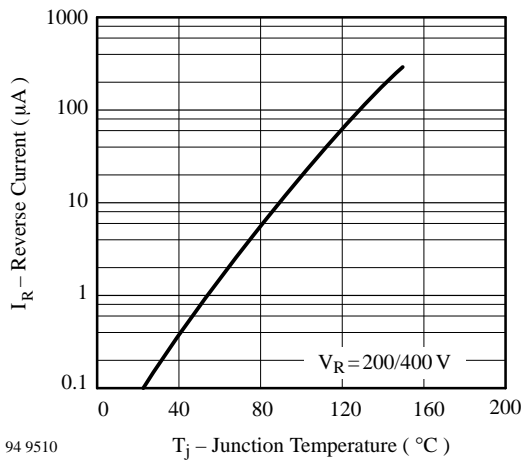

Figure 4. Reverse Current vs. Junction Temperature

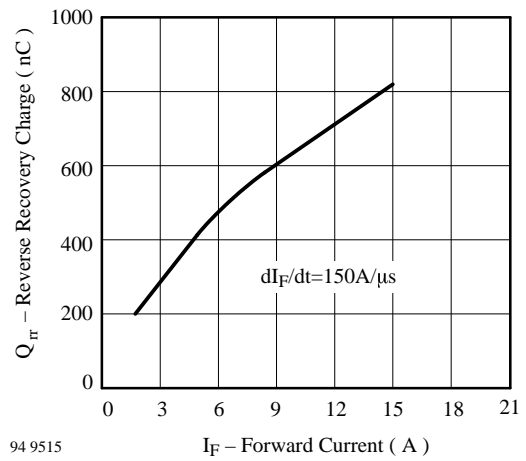

Figure 7. Reverse Recovery Charge vs. Forward Current

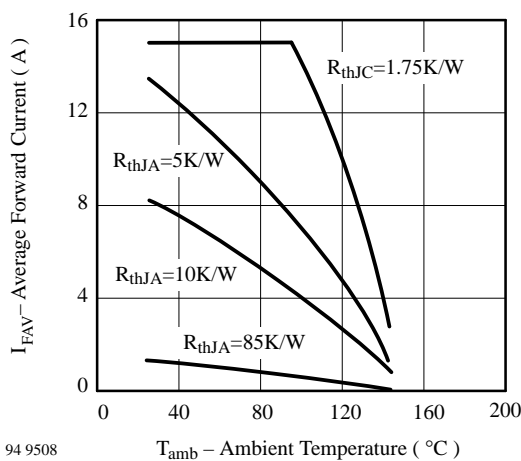

Figure 5. Average Forward Current vs. Ambient Temperature

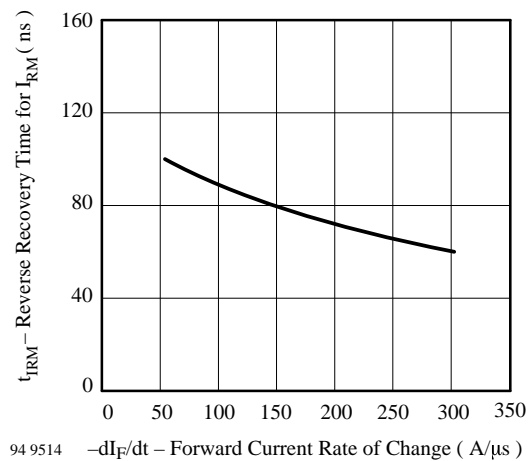

Figure 8. Reverse Recovery Time for IRM vs. Forward Current Rate of Change

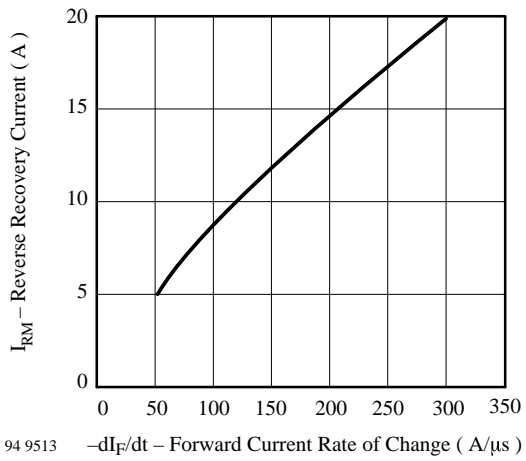

Figure 9. Reverse Recovery Current vs. Forward Current Rate of Change

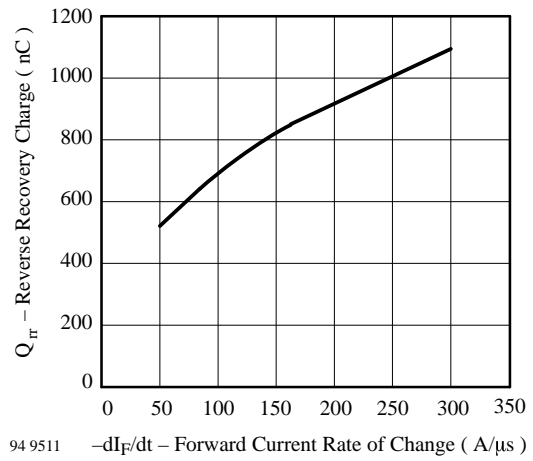

Figure 11. Reverse Recovery Charge vs. Forward Current Rate of Change

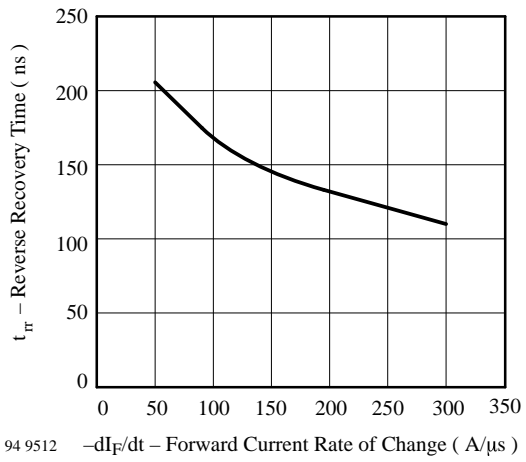
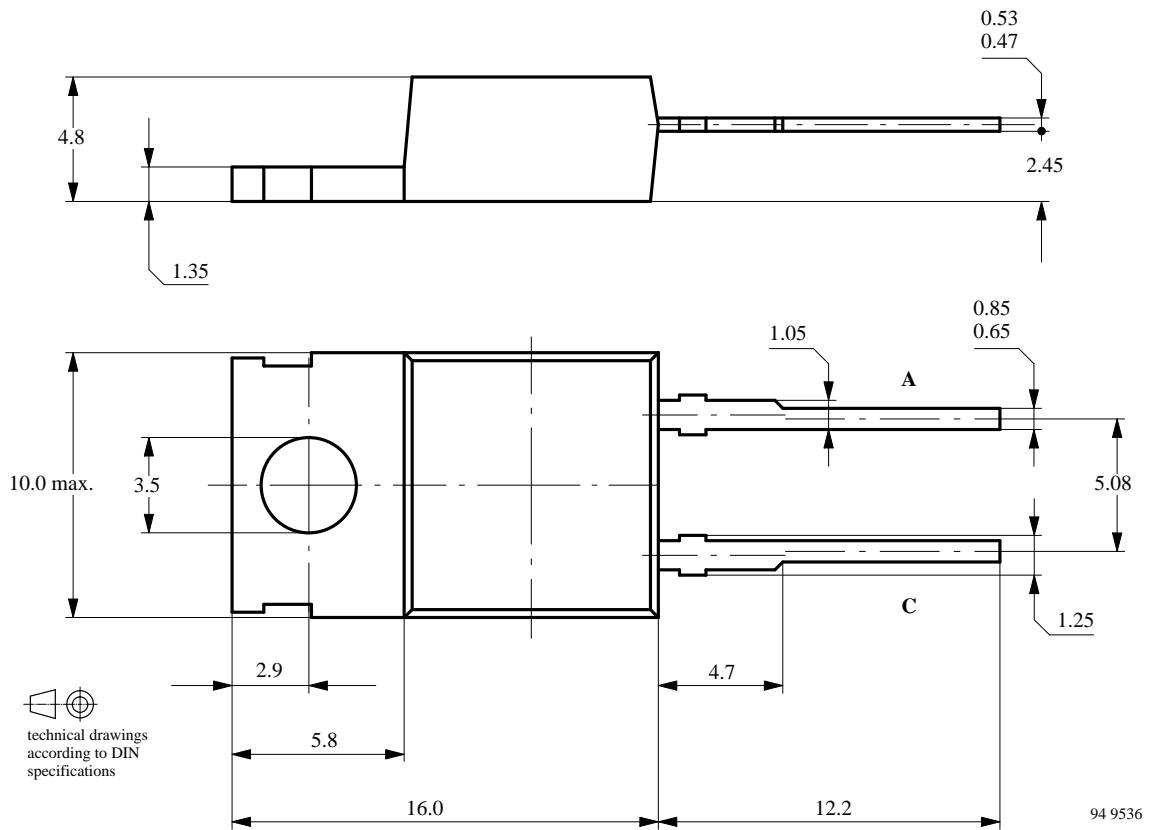

Figure 10. Reverse Recovery Time vs. Forward Current Rate of Change

Dimensions in mm



Cathode connected with metallic surface , Plastic Case DO 220 , Weight max.: 2.5 g

Ozone Depleting Substances Policy Statement

It is the policy of **TEMIC TELEFUNKEN microelectronic GmbH** to

1. Meet all present and future national and international statutory requirements.
2. Regularly and continuously improve the performance of our products, processes, distribution and operating systems with respect to their impact on the health and safety of our employees and the public, as well as their impact on the environment.

It is particular concern to control or eliminate releases of those substances into the atmosphere which are known as ozone depleting substances (ODSs).

The Montreal Protocol (1987) and its London Amendments (1990) intend to severely restrict the use of ODSs and forbid their use within the next ten years. Various national and international initiatives are pressing for an earlier ban on these substances.

TEMIC TELEFUNKEN microelectronic GmbH semiconductor division has been able to use its policy of continuous improvements to eliminate the use of ODSs listed in the following documents.

1. Annex A, B and list of transitional substances of the Montreal Protocol and the London Amendments respectively
2. Class I and II ozone depleting substances in the Clean Air Act Amendments of 1990 by the Environmental Protection Agency (EPA) in the USA
3. Council Decision 88/540/EEC and 91/690/EEC Annex A, B and C (transitional substances) respectively.

TEMIC can certify that our semiconductors are not manufactured with ozone depleting substances and do not contain such substances.

We reserve the right to make changes to improve technical design and may do so without further notice.

Parameters can vary in different applications. All operating parameters must be validated for each customer application by the customer. Should the buyer use TEMIC products for any unintended or unauthorized application, the buyer shall indemnify TEMIC against all claims, costs, damages, and expenses, arising out of, directly or indirectly, any claim of personal damage, injury or death associated with such unintended or unauthorized use.

TEMIC TELEFUNKEN microelectronic GmbH, P.O.B. 3535, D-74025 Heilbronn, Germany
Telephone: 49 (0)7131 67 2831, Fax number: 49 (0)7131 67 2423