

**Major Ratings and Characteristics**

Characteristics	50HQ...	Units
$I_{F(AV)}$ Rectangular waveform	60	A
$V_{RRM}$ range	35 to 45	V
$I_{FSM}$ @ $t_p=5\mu s$ sine	10,800	A
$V_F$ @ 60 Apk, $T_J=125^\circ C$	0.53	V
$T_J$ range	-65 to 150	$^\circ C$

**Description/ Features**

The 50HQ Schottky rectifier series has been optimized for very low forward voltage drop, with moderate leakage. The proprietary barrier technology allows for reliable operation up to 150° C junction temperature. Typical applications are in switching power supplies, converters, free-wheeling diodes, and reverse battery protection.

- 150° C  $T_J$  operation
- Very low forward voltage drop
- High frequency operation
- Guard ring for enhanced ruggedness and long term reliability
- Hermetic packaging

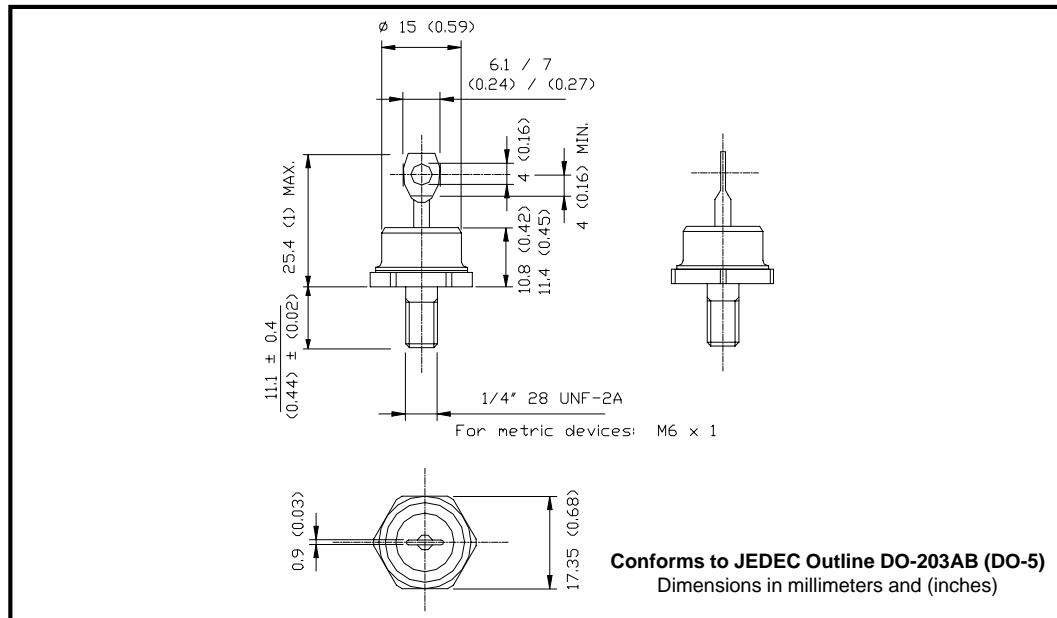

## 50HQ... Series

Bulletin PD-2.032 rev. G 11/02

International  

### Voltage Ratings

Part number	50HQ035	50HQ040	50HQ045
$V_R$ Max. DC Reverse Voltage (V)	35	40	45
$V_{RWM}$ Max. Working Peak Reverse Voltage (V)			

### Absolute Maximum Ratings

Parameters	50HQ	Units	Conditions
$I_{F(AV)}$ Max. Average Forward Current * See Fig. 5	60	A	50% duty cycle @ $T_C = 101^\circ\text{C}$ , rectangular wave form
$I_{FSM}$ Max. Peak One Cycle Non-Repetitive Surge Current * See Fig. 7	10,800	A	Following any rated load condition and with rated $V_{RWM}$ applied
	1150		
$E_{AS}$ Non-Repetitive Avalanche Energy	81	mJ	$T_J = 25^\circ\text{C}$ , $I_{AS} = 12$ Amps, $L = 1.12$ mH
$I_{AR}$ Repetitive Avalanche Current	12	A	Current decaying linearly to zero in 1 $\mu\text{sec}$ Frequency limited by $T_J$ max. $V_A = 1.5 \times V_R$ typical

### Electrical Specifications

Parameters	50HQ	Units	Conditions
$V_{FM}$ Max. Forward Voltage Drop (1) * See Fig. 1	0.60	V	@ 60A $T_J = 25^\circ\text{C}$
	0.78	V	@ 120A
	0.53	V	@ 60A $T_J = 125^\circ\text{C}$
	0.69	V	@ 120A
$I_{RM}$ Max. Reverse Leakage Current (1) * See Fig. 2	5	mA	$T_J = 25^\circ\text{C}$
	200	mA	$T_J = 125^\circ\text{C}$ $V_R = \text{rated } V_R$
$C_T$ Max. Junction Capacitance	2600	pF	$V_R = 5V_{DC}$ , (test signal range 100Khz to 1Mhz) $25^\circ\text{C}$
$L_S$ Typical Series Inductance	7.5	nH	Measured from top of terminal to mounting plane
dv/dt Max. Voltage Rate of Change	10000	V/ $\mu\text{s}$	(Rated $V_R$ )

(1) Pulse Width < 300 $\mu\text{s}$ , Duty Cycle < 2%

### Thermal-Mechanical Specifications

Parameters	50HQ	Units	Conditions
$T_J$ Max. Junction Temperature Range	-65 to 150	$^\circ\text{C}$	
$T_{stg}$ Max. Storage Temperature Range	-65 to 150	$^\circ\text{C}$	
$R_{thJC}$ Max. Thermal Resistance Junction to Case	0.83	$^\circ\text{C/W}$	DC operation * See Fig. 4
$R_{thCS}$ Typical Thermal Resistance, Case to Heatsink	0.25	$^\circ\text{C/W}$	Mounting surface, smooth and greased
wt Approximate Weight	15 (0.53)	g (oz.)	
T Mounting Torque	Min.	23 (20)	Non-lubricated threads
	Max.	46 (40)	
Case Style	DO-203AB(DO-5)	JEDEC	

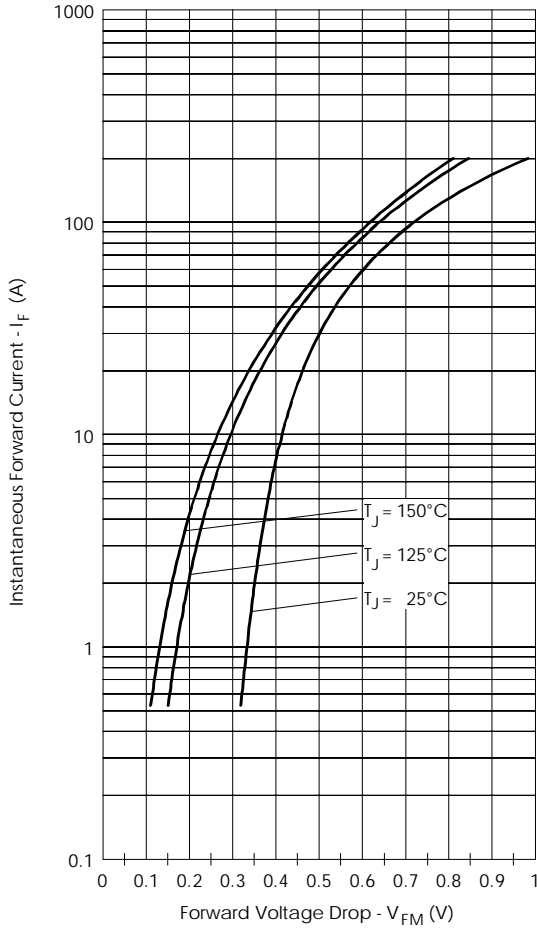

Fig. 1 - Maximum Forward Voltage Drop Characteristics

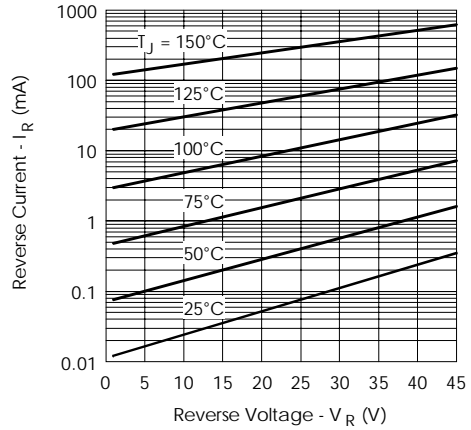

Fig. 2 - Typical Values of Reverse Current Vs. Reverse Voltage

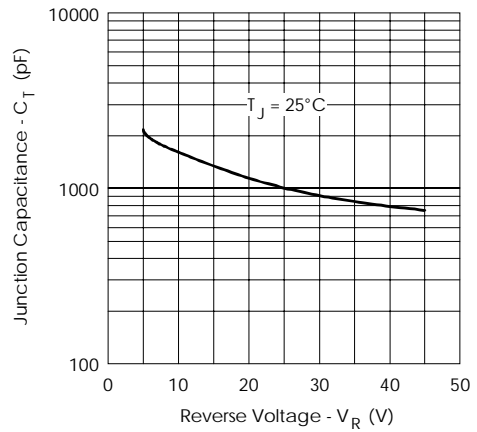

Fig. 3 - Typical Junction Capacitance Vs. Reverse Voltage

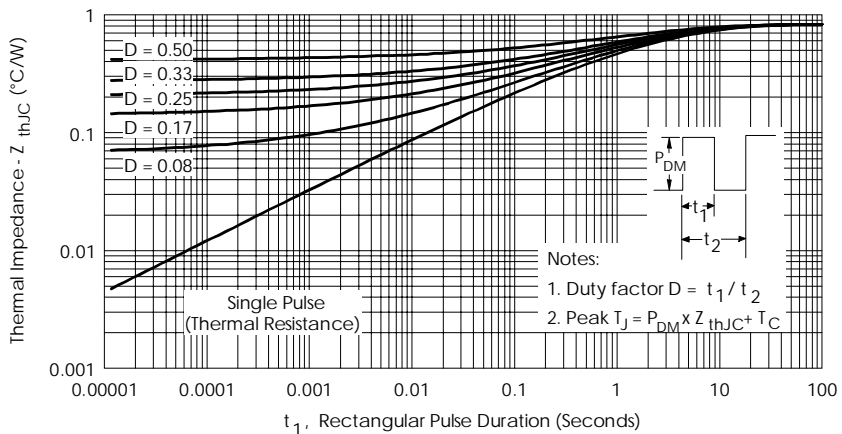

Fig. 4 - Maximum Thermal Impedance  $Z_{thJC}$  Characteristics

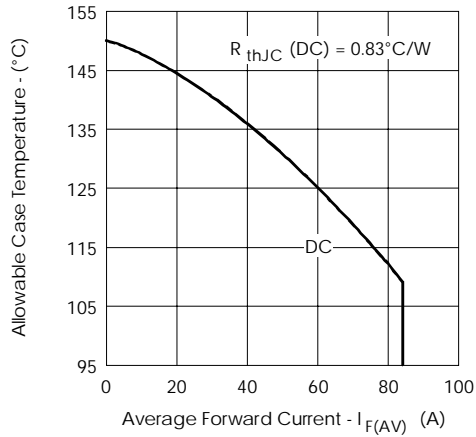

Fig. 5 - Maximum Allowable Case Temperature Vs. Average Forward Current

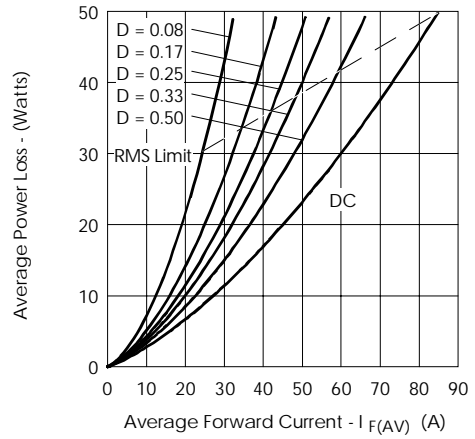

Fig. 6 - Forward Power Loss Characteristics

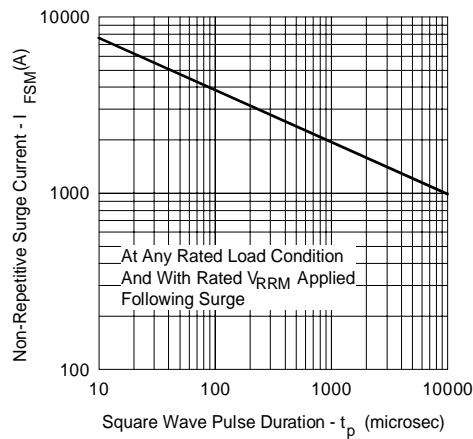

Fig. 7 - Maximum Non-Repetitive Surge Current

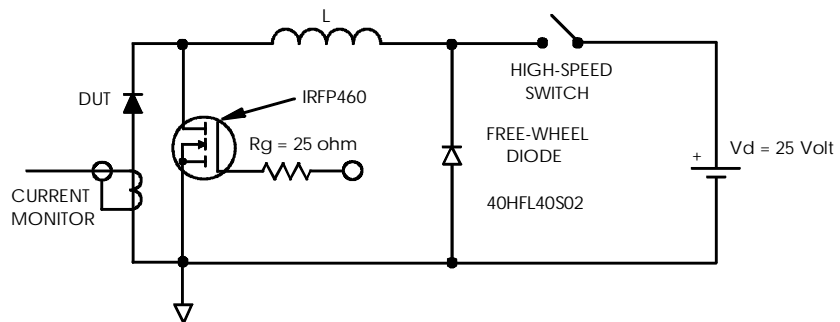

Fig. 8 - Unclamped Inductive Test Circuit

Data and specifications subject to change without notice.  
This product has been designed for Industrial Level.  
Qualification Standards can be found on IR's Web site.

International  
**IOR** Rectifier

**IR WORLD HEADQUARTERS:** 233 Kansas St., El Segundo, California 90245, USA Tel: (310) 252-7105  
TAC Fax: (310) 252-7309  
Visit us at [www.irf.com](http://www.irf.com) for sales contact information. 11/02