

STANDARD RECOVERY DIODES

Stud Version

Features

- Diffused diode
- High voltage ratings up to 1200V
- High surge current capabilities
- Stud cathode and stud anode version
- Hermetic metal case

150A

Typical Applications

- Welders
- Power supplies
- Machine tool controls
- High power drives
- Medium traction applications
- Battery charges
- Free-wheeling diodes

Major Ratings and Characteristics

| Parameters | 150U(R).. | Units |
|------------------|--------------|-------------------|
| $I_{F(AV)}$ | 150 | A |
| @ T_C | 125 | °C |
| $I_{F(RMS)}$ | 235 | A |
| I_{FSM} @ 50Hz | 3000 | A |
| @ 60Hz | 3140 | A |
| I^2t @ 50Hz | 45 | KA ² s |
| @ 60Hz | 41 | KA ² s |
| V_{RRM} range | 600 and 1200 | V |
| T_J | - 40 to 180 | °C |

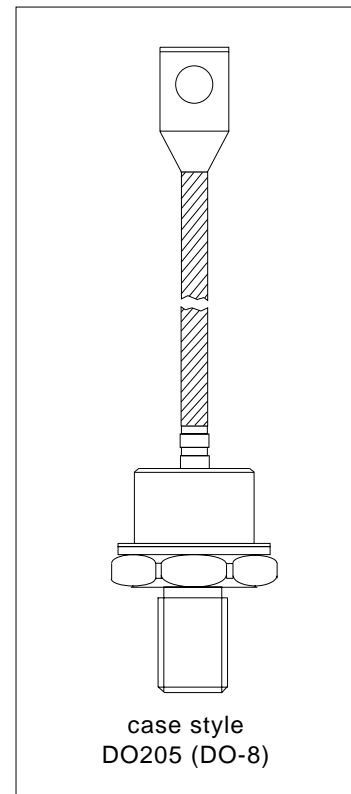

150U(R).. Series

Bulletin I2025 rev. D 03/03

International
IR Rectifier

ELECTRICAL SPECIFICATIONS

Voltage Ratings

| Type number | Voltage Code | V_{RRM} , maximum repetitive peak reverse voltage V | V_{RSM} , maximum non-repetitive peak rev. voltage V | I_{RRM} max. @ $T_J = T_J$ max. mA |
|-------------|--------------|----------------------------------------------------------|-----------------------------------------------------------|--------------------------------------------|
| 150U(R).. | 60 | 600 | 700 | 15 |
| | 80 | 800 | 900 | |
| | 100 | 1000 | 1100 | |
| | 120 | 1200 | 1300 | |

Forward Conduction

| Parameter | 150U(R).. | Units | Conditions | | |
|-------------------------------------------------------------------------|-----------|-------------------|---------------------------------------------------------------|-------------------------|---------------------------------------------------|
| $I_{F(AV)}$ Max. average forward current @ Case temperature | 150 | A | 180° conduction, half sine wave | | |
| | 125 | °C | | | |
| $I_{F(RMS)}$ Max. RMS forward current | 235 | A | Dc @ 110°C | | |
| I_{FSM} Max. peak, one-cycle forward, non-repetitive surge current | 3000 | A | t = 10ms | No voltage reapplied | Sinusoidal half wave, Initial $T_J = T_J$ max. |
| | 3140 | | t = 8.3ms | | |
| I^2t Maximum I^2t for fusing | 45 | KA ² s | t = 10ms | No voltage reapplied | |
| | 41 | | t = 8.3ms | | |
| r_f Slope resistance | 0.97 | mΩ | @ $T_J = T_J$ max. | | |
| $V_{F(T0)}$ Threshold voltage | 0.80 | V | | | |
| V_{FM} Max. forward voltage drop | 1.47 | V | $I_{pk} = 600A$, $T_J = 25°C$, $t_p = 10ms$ sinusoidal wave | | |

Thermal and Mechanical Specifications

| Parameter | 150U(R).. | Units | Conditions |
|------------------------------------------------------|---------------|-------|--------------------------------------------|
| T_J Max. junction operating temperature range | -40 to 180 | °C | |
| T_{stg} Max. storage temperature range | -40 to 180 | | |
| R_{thJC} Max. thermal resistance, junction to case | 0.3 | K/W | DC operation |
| R_{thCS} Max. thermal resistance, case to heatsink | 0.1 | | Mounting surface, smooth, flat and greased |
| T Max. allowed mounting torque +0 -20% | 17 | Nm | Not lubricated threads |
| | 14.5 | | Lubricated threads |
| wt Approximate weight | 130 | g | |
| Case style | DO-205 (DO-8) | | See Outline Table |

ΔR_{thJC} Conduction

(The following table shows the increment of thermal resistance R_{thJC} when devices operate at different conduction angles than DC)

| Conduction angle | Sinusoidal conduction | Rectangular conduction | Units | Conditions |
|------------------|-----------------------|------------------------|-------|------------------|
| 180° | 0.031 | 0.023 | K/W | $T_J = T_J$ max. |
| 120° | 0.038 | 0.040 | | |
| 90° | 0.048 | 0.053 | | |
| 60° | 0.071 | 0.075 | | |
| 30° | 0.120 | 0.121 | | |

Ordering Information Table

| Device Code | | | | | | |
|-------------|---|---|---|-----|---|---|
| 1 | 2 | 3 | 4 | 5 | 6 | 7 |
| 15 | 0 | U | R | 120 | D | L |

- 1** - 15 = Essential Part Number
- 2** - 0 = Standard Device
- 3** - U = Stud Normal Polarity (Cathode to Stud)
- 4** - None = Stud Normal Polarity (Cathode to Stud)
 R = Stud Reverse Polarity (Anode to Stud)
- 5** - Voltage code: Code x 10 = V_{RRM} (See Voltage Ratings table)
- 6** - Diffused diode
- 7** - L = Stud base 1/2" - 20UNF-2A threads
 None = Stud base 3/8" - 24UNF-2A threads

NOTE: For Metric Device M12 x 1.75 Contact Factory

Outline Table

GLASS-METAL SEAL

16.5 (0.65) MAX.

2.6 (0.10) MAX.

6.5 (0.26) MIN.

35 (1.38) MAX.

DIA. 8.5 (0.33) NOM.

C.S. 16mm² (0.015 s.i.)

165 (6.49) MIN.

170 (6.69) MAX.

55 (2.16) MIN.

DIA. 23.5 (0.93) MAX.

24 (0.94) MAX.

17 (0.69) MAX.

3/8"-24UNF-2A *

150U(R) Series
 Conforms to JEDEC DO-205 (DO-8)
 All dimensions in millimeters (inches)

* FOR METRIC DEVICE M12 x 1.75
 * FOR STUD BASE 1/2" - 20UNF-2A THREADS; refer "Ordering Information Table"

150U(R).. Series

Bulletin I2025 rev. D 03/03

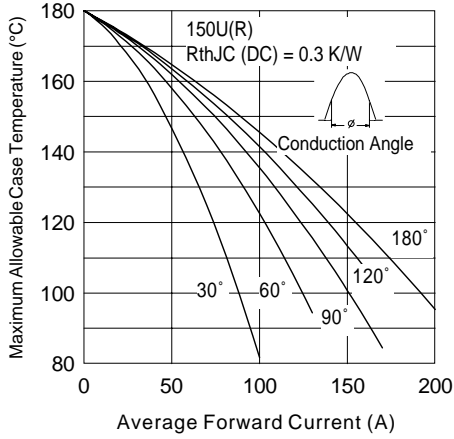

Fig. 1 - Current Ratings Characteristics

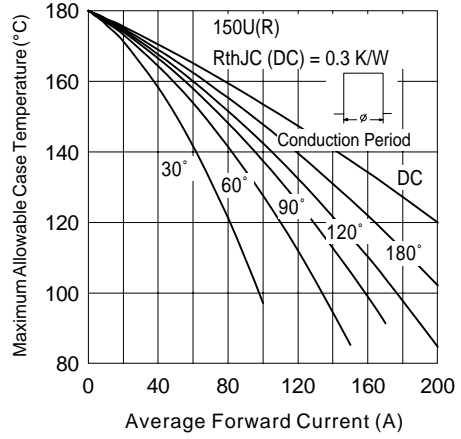

Fig. 2 - Current Ratings Characteristics

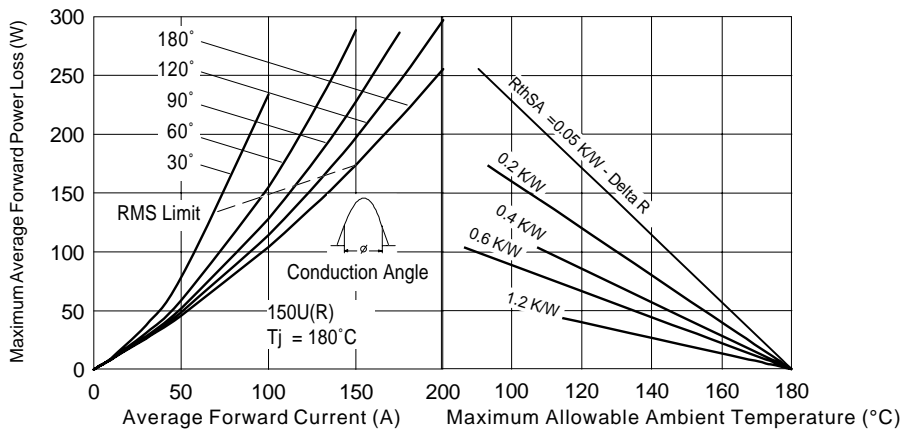

Fig. 3 - Forward Power Loss Characteristics

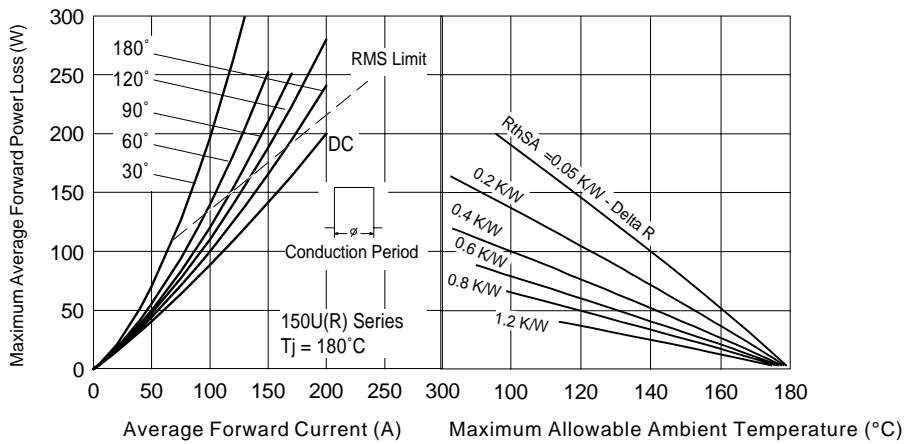
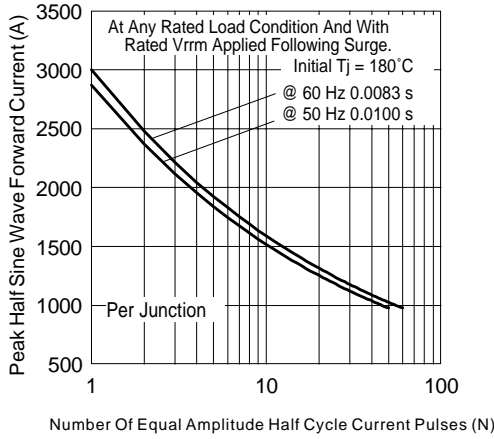
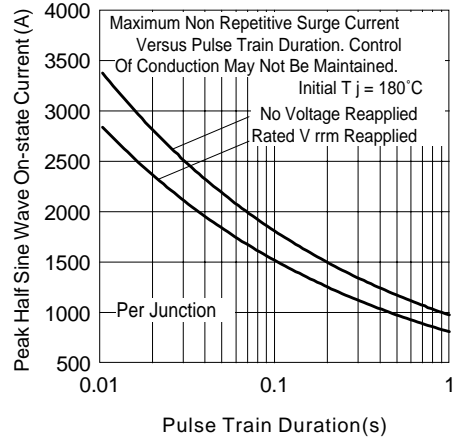

Fig. 4 - Forward Power Loss Characteristics



Number Of Equal Amplitude Half Cycle Current Pulses (N)

Fig. 5 - Maximum Non-Repetitive Surge Current



Pulse Train Duration(s)

Fig. 6 - Maximum Non-Repetitive Surge Current

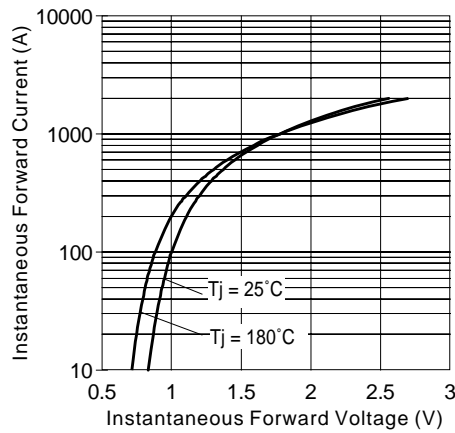

Fig. 7 - Forward Voltage Drop Characteristics

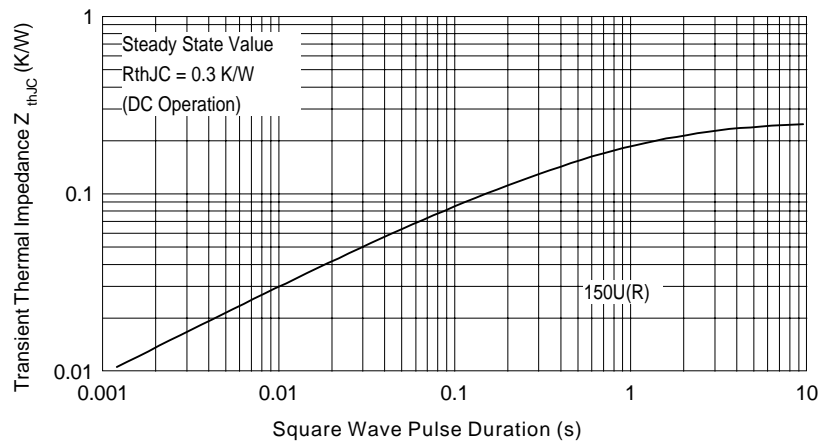

Fig. 8 - Thermal Impedance Z_{thJC} Characteristic

150U(R).. Series

Bulletin I2025 rev. D 03/03

International
IOR Rectifier

Data and specifications subject to change without notice.
This product has been designed and qualified for Industrial Level.
Qualification Standards can be found on IR's Web site.

International
IOR Rectifier

IR WORLD HEADQUARTERS: 233 Kansas St., El Segundo, California 90245, USA Tel: (310) 252-7105
TAC Fax: (310) 252-7309
Visit us at www.irf.com for sales contact information. 03/03