

BIPOLAR ANALOG INTEGRATED CIRCUIT

μ PC814

DUAL J-FET INPUT LOW-OFF SET OPERATIONAL AMPLIFIER

DESCRIPTION

Dual operational amplifier μ PC814 is a high-speed version of the μ PC812. NEC's unique high-speed PNP transistor ($f_T = 300$ MHz) in the output stage yields a high slew rate of 25 V/ μ s under voltage-follower conditions without an oscillation problem. Zener-zap resistor trimming in the input stage produces excellent offset voltage and temperature drift characteristics.

Having AC performance characteristics that are two times better than conventional bi-FET op amps, the μ PC814 is ideal for fast integrators, active filters, and other high-speed circuit applications.

FEATURES

- High slew rate: 25 V/ μ s (TYP.)
- Stable operation with 220 pF capacitive load
- Low input offset voltage
 ± 3 mV (MAX.)
- ± 7 μ V/ $^{\circ}$ C (TYP.) temperature drift
- Very low input bias and offset currents
- Low noise: $e_n = 19$ nV/ $\sqrt{\text{Hz}}$ (TYP.)
- Output short circuit protection
- High input impedance ... J-FET Input Stage
- Internal frequency compensation

EQUIVALENT CIRCUIT (1/2 Circuit)

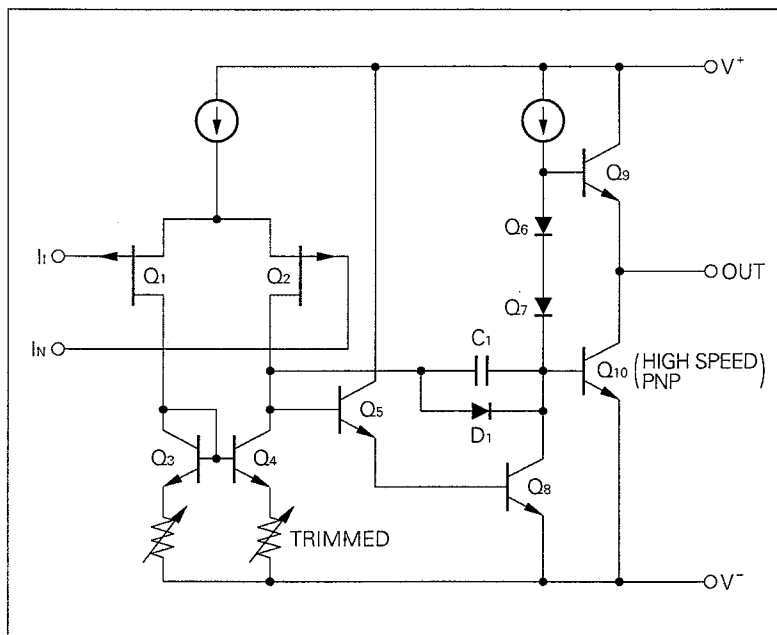

CONNECTION DIAGRAM (Top View)

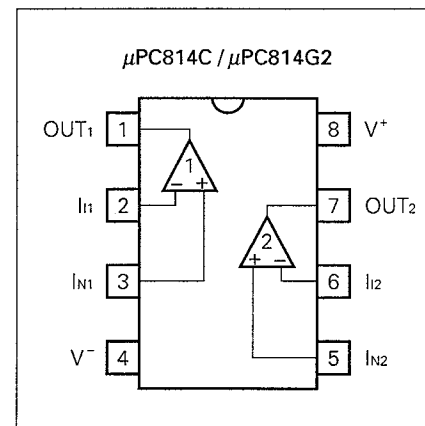

ORDERING INFORMATION

PART NUMBER	PACKAGE	QUALITY GRADE
μ PC814C	8 PIN PLASTIC DIP (300 mil)	Standard
μ PC814G2	8 PIN PLASTIC SOP (225 mil)	Standard

Please refer to "Quality grade on NEC Semiconductor Devices" (Document number IEI-1209) published by NEC Corporation to know the specification of quality grade on the devices and its recommended applications.

ABSOLUTE MAXIMUM RATINGS (T_a = 25 °C)

PARAMETER		SYMBOL	μPC814	UNIT
Voltage between V ⁺ and V ⁻ (Note 1)		V ⁺ - V ⁻	-0.3 to +36	V
Differential Input Voltage		V _{ID}	±30	V
Input Voltage (Note 2)		V _I	V ⁻ -0.3 to V ⁺ +0.3	V
Output Voltage (Note 3)		V _O	V ⁻ -0.3 to V ⁺ +0.3	V
Power Dissipation	C Package (Note 4)	P _T	350	mW
	G2 Package (Note 5)		440	mW
Output Short Circuit Duration (Note 6)			Indefinite	sec
Operating Temperature Range		T _{opt}	-40 to +85	°C
Storage Temperature Range		T _{stg}	-55 to +125	°C

Note 1. Reverse connection of supply voltage can cause destruction.

Note 2. The input voltage should be allowed to input without damage or destruction. Even during the transition period of supply voltage, power on/off etc., this specification should be kept. The normal operation will establish when the both inputs are within the Common Mode Input Voltage Range of electrical characteristics.

Note 3. This specification is the voltage which should be allowed to supply to the output terminal from external without damage or destructive. Even during the transition period of supply voltage, power on/off etc., this specification should be kept. The output voltage of normal operation will be the Output Voltage Swing of electrical characteristics.

Note 4. Thermal derating factor is -5.0 mW / °C when ambient temperature is higher than 55 °C.

Note 5. Thermal derating factor is -4.4 mW / °C when ambient temperature is higher than 25 °C.

Note 6. Pay careful attention to the total power dissipation not to exceed the absolute maximum ratings, Note 4 and Note 5.

RECOMMENDED OPERATING CONDITIONS

CHARACTERISTIC	SYMBOL	MIN.	TYP.	MAX.	UNIT
Supply Voltage	V [±]	± 5		± 16	V
Output Current	I _o			± 10	mA
Capacitive Load (A _v = +1, R _f = 0 Ω)	C _L			220	pF

ELECTRICAL CHARACTERISTICS ($T_a = 25\text{ }^\circ\text{C}$, $V^\pm = \pm 15\text{ V}$)

CHARACTERISTIC	SYMBOL	MIN.	TYP.	MAX.	UNIT	CONDITIONS
Input Offset Voltage	V_{io}		± 1	± 2.5	mV	$R_s \leq 50\ \Omega$
Input Offset Current (Note 7)	I_{io}		± 25	± 100	pA	
Input Bias Current (Note 7)	I_B		50	200	pA	
Large Signal Voltage Gain	A_v	25	200		V/mV	$R_L \geq 2\ \text{k}\Omega$, $V_o = \pm 10\ \text{V}$
Supply Current	I_{cc}		2.5	3.4	mA	$I_o = 0\ \text{A}$, Both Amplifier
Common Mode Rejection Ratio	CMR	70	100		dB	
Supply Voltage Rejection Ratio	SVR	70	100		dB	
Output Voltage Swing	V_{om}	± 12	+14.0 -13.3		V	$R_L \geq 10\ \text{k}\Omega$
Output Voltage Swing	V_{om}	± 10	+13.5 -12.8		V	$R_L \geq 2\ \text{k}\Omega$
Common Mode Input Voltage Range	V_{icm}	± 11	+14 -12		V	
Slew Rate	SR		15		V/ μ s	$A_v = 1$
Unity Gain Frequency	f_{unity}		4		MHz	
Input Equivalent Noise Voltage Density	e_n		19		nV/ $\sqrt{\text{Hz}}$	$R_s = 100\ \Omega$, $f = 1\ \text{kHz}$
Channel Separation			120		dB	
Input Offset Voltage	V_{io}			± 5	mV	$R_s \leq 50\ \Omega$, $T_a = -20\ \text{to}\ +70\ ^\circ\text{C}$
Average V_{io} Temperature Drift	$\Delta V_{io}/\Delta T$		± 7		$\mu\text{V}/^\circ\text{C}$	$T_a = -20\ \text{to}\ +70\ ^\circ\text{C}$
Input Offset Current (Note 7)	I_{io}			± 2	nA	$T_a = -20\ \text{to}\ +70\ ^\circ\text{C}$
Input Bias Current (Note 7)	I_B			7	nA	$T_a = -20\ \text{to}\ +70\ ^\circ\text{C}$

Note 7. Input bias currents flow into IC. Because each currents are gate leak current of P-channel J-FET on input stage.

And that are temperature sensitive. Short time measuring method is recommendable to maintain the junction temperature close to the ambient temperature.

TYPICAL PERFORMANCE CHARACTERISTICS ($T_a = 25^\circ\text{C}$, TYP.)

POWER DISSIPATION

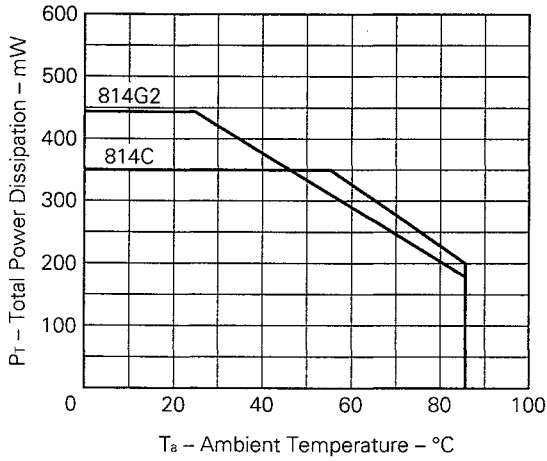

OPEN LOOP FREQUENCY RESPONSE

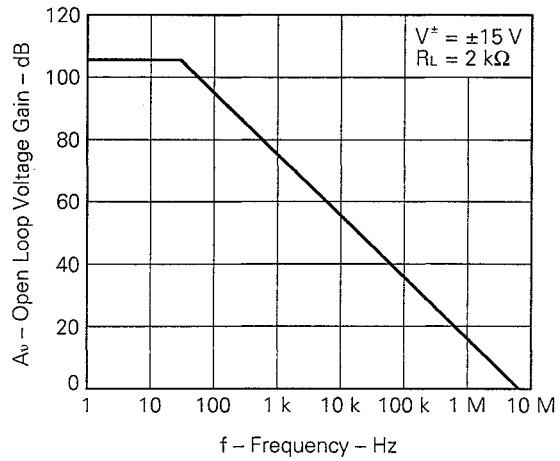

LARGE SIGNAL FREQUENCY RESPONSE

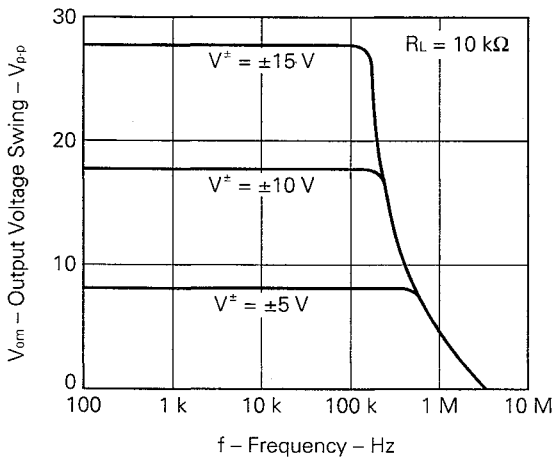

OUTPUT VOLTAGE SWING

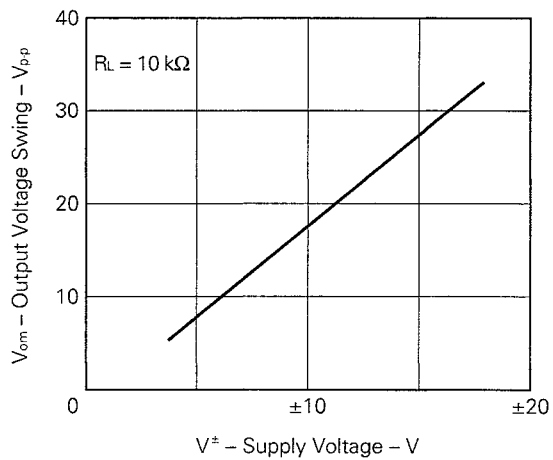

OUTPUT SOURCE CURRENT LIMIT

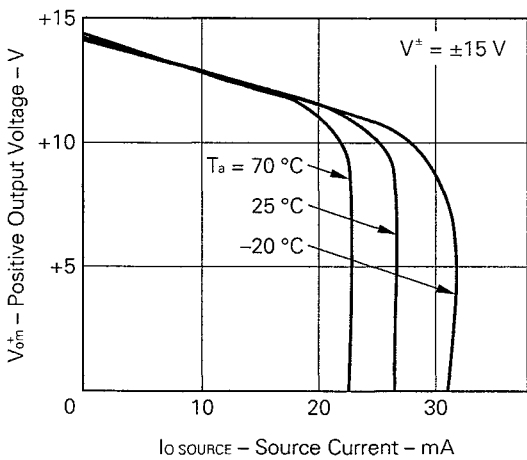

OUTPUT SINK CURRENT LIMIT

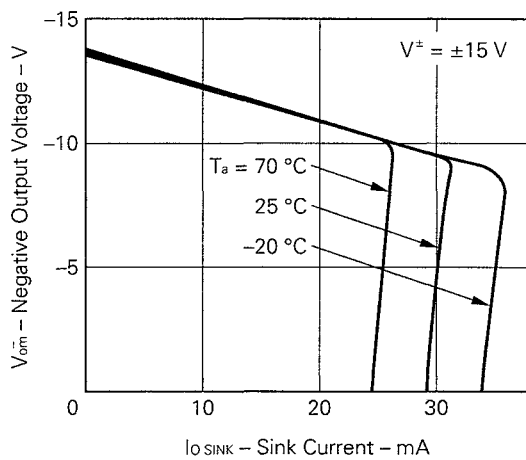

VOLTAGE FOLLOWER PULSE RESPONSE

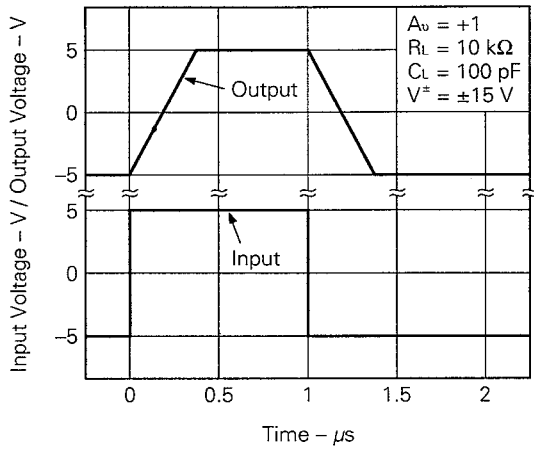

INPUT EQUIVALENT NOISE VOLTAGE DENSITY

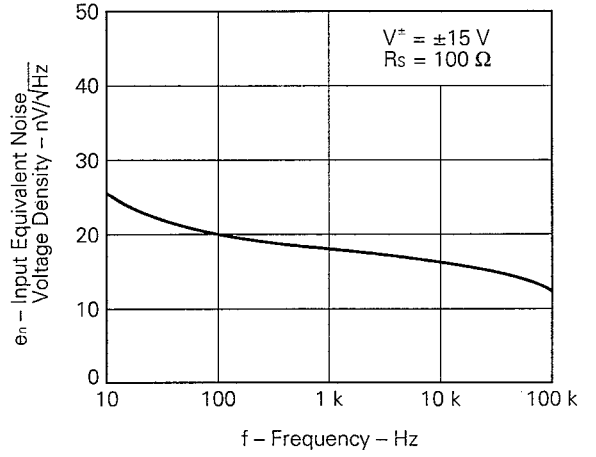

INPUT BIAS CURRENT

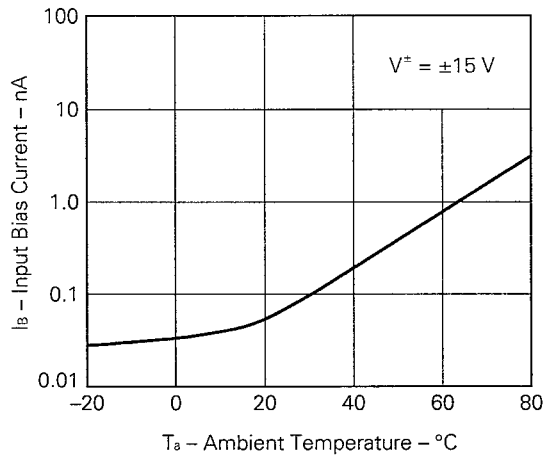

SUPPLY CURRENT

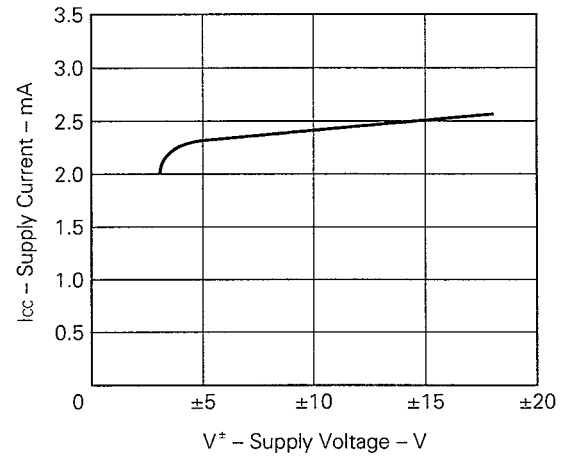

8PIN PLASTIC DIP (300 mil)

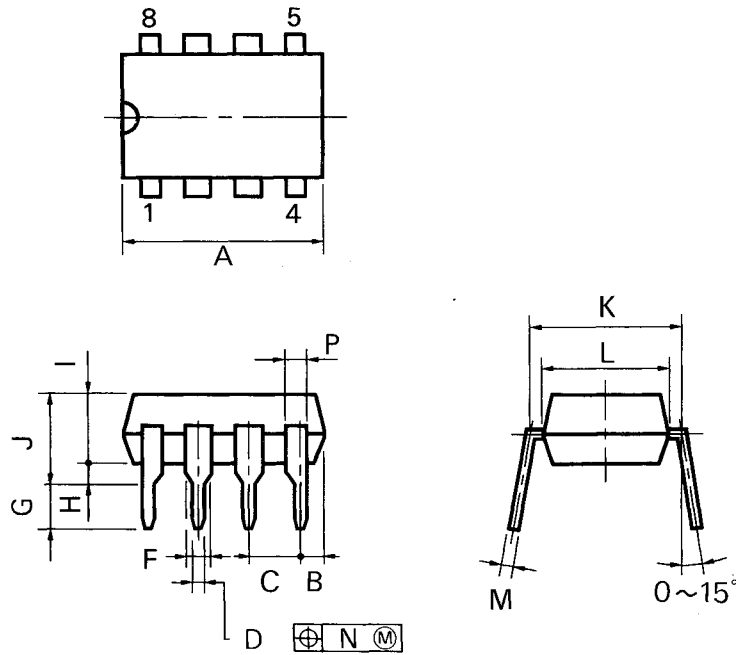

P8C-100-300B,C

NOTES

- 1) Each lead centerline is located within 0.25 mm (0.01 inch) of its true position (T.P.) at maximum material condition.
- 2) Item "K" to center of leads when formed parallel.

ITEM	MILLIMETERS	INCHES
A	10.16 MAX.	0.400 MAX.
B	1.27 MAX.	0.050 MAX.
C	2.54 (T.P.)	0.100 (T.P.)
D	0.50 ^{+0.10}	0.020 ^{+0.004} _{-0.005}
F	1.4 MIN.	0.055 MIN.
G	3.2 ^{+0.3}	0.126 ^{+0.012}
H	0.51 MIN.	0.020 MIN.
I	4.31 MAX.	0.170 MAX.
J	5.08 MAX.	0.200 MAX.
K	7.62 (T.P.)	0.300 (T.P.)
L	6.4	0.252
M	0.25 ^{+0.10} _{-0.05}	0.010 ^{+0.004} _{-0.003}
N	0.25	0.01
P	0.9 MIN.	0.035 MIN.

8 PIN PLASTIC SOP (225 mil)

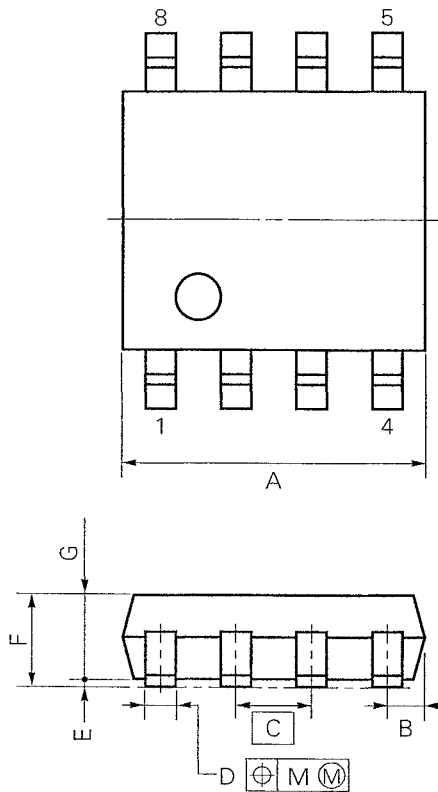

detail of lead end

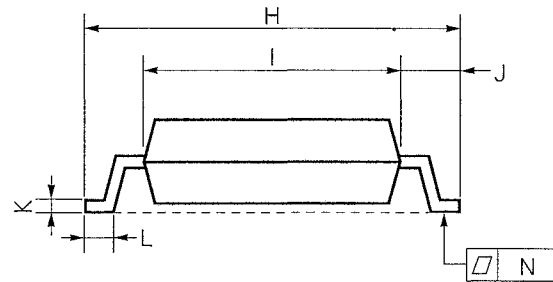
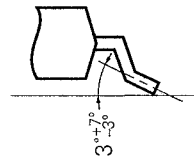

NOTE

Each lead centerline is located within 0.12 mm (0.005 inch) of its true position (T.P.) at maximum material condition.

S8GM-50-225B-2

ITEM	MILLIMETERS	INCHES
A	5.37 MAX.	0.212 MAX.
B	0.78 MAX.	0.031 MAX.
C	1.27 (T.P.)	0.050 (T.P.)
D	0.40 ^{+0.10} _{-0.05}	0.016 ^{+0.004} _{-0.003}
E	0.1±0.1	0.004±0.004
F	1.8 MAX.	0.071MAX.
G	1.49	0.059
H	6.5±0.3	0.256±0.012
I	4.4	0.173
J	1.1	0.043
K	0.15 ^{+0.10} _{-0.05}	0.006 ^{+0.004} _{-0.002}
L	0.6±0.2	0.024 ^{+0.008} _{-0.009}
M	0.12	0.005
N	0.15	0.006

RECOMMENDED SOLDERING CONDITIONS

The following conditions (see table below) must be met when soldering this product.
Please consult with our sales offices in case other soldering process is used, or in case soldering is done under different conditions.

TYPES OF SURFACE MOUNT DEVICE

For more details, refer to our document "SEMICONDUCTOR DEVICE MOUNTING TECHNOLOGY MANUAL" (IEI-1207).

[μPC814G2]

Soldering method	Soldering conditions	Recommended condition symbol
Infrared ray reflow	Peak package's surface temperature: 230 °C or below, Reflow time: 30 seconds or below (210 °C or higher), Number of reflow process: 1, Exposure limit*: None	IR30-00-1
VPS	Peak package's surface temperature: 215 °C or below, Reflow time: 40 seconds or below (200 °C or higher), Number of reflow process: 1, Exposure limit*: None	VP15-00-1
Wave soldering	Solder temperature: 260 °C or below, Flow time: 10 seconds or below, Number of flow process: 1, Exposure limit*: None	WS15-00-1
Partial heating method	Terminal temperature: 300 °C or below, Flow time: 10 seconds or below, Exposure limit*: None	

*: Exposure limit before soldering after dry-pack package is opened.
Storage conditions: 25 °C and relative humidity at 65 % or less.

Note: Do not apply more than a single process at once, except for "Partial heating method."

TYPES OF THROUGH HOLE DEVICE

[μPC814C]

Soldering method	Soldering conditions	Recommended condition symbol
Wave soldering	Solder temperature: 260 °C or below, Flow time: 10 seconds or below	

[MEMO]

[MEMO]

No part of this document may be copied or reproduced in any form or by any means without the prior written consent of NEC Corporation. NEC Corporation assumes no responsibility for any errors which may appear in this document.

NEC Corporation does not assume any liability for infringement of patents, copyrights or other intellectual property rights of third parties by or arising from use of a device described herein or any other liability arising from use of such device. No license, either express, implied or otherwise, is granted under any patents, copyrights or other intellectual property rights of NEC Corporation or others.

The devices listed in this document are not suitable for use in aerospace equipment, submarine cables, nuclear reactor control systems and life support systems. If customers intend to use NEC devices for above applications or they intend to use "Standard" quality grade NEC devices for applications not intended by NEC, please contact our sales people in advance.

Application examples recommended by NEC Corporation.

Standard: Computer, Office equipment, Communication equipment, Test and Measurement equipment, Machine tools, Industrial robots, Audio and Visual equipment, Other consumer products, etc.

Special: Automotive and Transportation equipment, Traffic control systems, Antidisaster systems, Anticrime systems, etc.