

UA592

MuA592 Differential Video Amplifier



Literature Number: SNOS252A

μA592 Differential Video Amplifier

General Description

The μA592 is a monolithic two-stage differential input, differential output video amplifier constructed using the Planar Epitaxial process. Internal series shunt feedback is used to obtain wide bandwidth, low phase distortion, and excellent gain stability. Emitter follower outputs enable the device to drive capacitive loads and all stages are current source biased to obtain high power supply and common mode rejection ratios.

The μA592, in the 14-lead version, offers fixed gains of 100 and 400 without external components. A fixed gain of 400 is available in the 8-lead part. Adjustable gains from 0 to 400 are obtained with one external resistor.

No external frequency compensation components are required for any gain option. The device is particularly useful in magnetic tape or disc file systems using phase or NRZ encoding. Other applications include general purpose video and pulse amplifiers.

Features

- 90 MHz bandwidth typ
- Selectable gains from 0 to 400 typ
- No frequency compensation required
- Adjustable pass band

Connection Diagrams

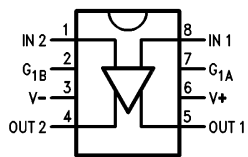
8-Lead DIP and SO-8 Package

TL/H/10047-1

Top View

Order Number μA592SC or μA592TC
See NS Package Number M08E or N08E

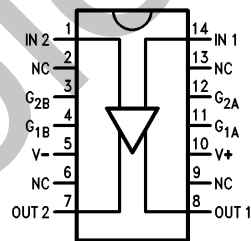
14-Lead DIP

TL/H/10047-2

Top View

Order Number μA592DC or μA592DM
See NS Package Number J14A

Order Information

Device Code	Package Code	Package Description
μA592TC	N08E	Molded DIP
μA592SC	M08A	Molded Surface Mount
μA592DM	J14A	Ceramic DIP
μA592DC	J14A	Ceramic DIP

Absolute Maximum Ratings

If Military/Aerospace specified devices are required, please contact the National Semiconductor Sales Office/Distributors for availability and specifications.

Storage Temperature Range	
Ceramic DIP	-65°C to +175°C
Molded DIP, SO-8	-65°C to +150°C
Operating Temperature Range	
Extended (μ A592M)	-55°C to +125°C
Commercial (μ A592C)	0°C to +70°C
Lead Temperature	
Ceramic DIP (Soldering, 60 sec.)	300°C
Molded DIP and SO Package (Soldering, 10 sec.)	265°C

Internal Power Dissipation (Notes 1, 2)

8L-Molded DIP	0.93W
SO-8	0.81W
14L-Molded DIP	1.04W
14L-Ceramic DIP	1.36W
Supply Voltage	$\pm 8.0V$
Differential Input Voltage	$\pm 5.0V$
Common Mode Input Voltage	$\pm 6.0V$
Output Current	10 mA

μ A592 and μ A592C

Electrical Characteristics $T_A = 25^\circ C$, $V_{CC} = \pm 6.0V$ unless otherwise specified.

Symbol	Parameter	Conditions (Notes 3, 4)	μ A592			μ A592C			Units	
			Min	Typ	Max	Min	Typ	Max		
A _{VD}	Differential Voltage Gain	R _L = 2.0 k Ω , V _O = 3.0 V _{P-P}	Gain 1	300	400	500	250	400	600	V/V
			Gain 2	90	100	110	80	100	120	
B _W	Bandwidth	R _S = 50 Ω	Gain 1		40			40		MHz
			Gain 2		90			90		
t _r	Risetime	R _S = 50 Ω , V _O = 1.0 V _{P-P}	Gain 1		10.5			10.5		ns
			Gain 2		4.5	10		4.5	12	
t _{pD}	Propagation Delay	R _S = 50 Ω , V _O = 1.0 V _{P-P}	Gain 1		7.5			7.5		ns
			Gain 2		6.0	10		6.0	10	
Z _I	Input Impedance		Gain 1		4.0			4.0		k Ω
			Gain 2	20	30		10	30		
C _I	Input Capacitance			2.0			2.0		pF	
I _{IO}	Input Offset Current			0.4	3.0		0.4	5.0	μ A	
I _{IB}	Input Bias Current			9.0	20		9.0	30	μ A	
e _n	Input Noise Voltage	R _S = 50 Ω , BW = 1.0 kHz to 10 MHz		12			12		μ V _{rms}	
V _{IR}	Input Voltage Range		± 1.0			± 1.0			V	
CMR	Common Mode Rejection	V _{CM} = 1.0V, Gain 2	60	86		60	86		dB	
PSRR	Power Supply Rejection Ratio	$\Delta V_{CC} = \pm 0.5V$, Gain 2	50	70		50	70		dB	
V _{OO}	Output Offset Voltage		Gain 1		0.6	1.5		0.6	1.5	V
			Gain 2		0.35	0.75		0.35	0.75	
V _{OCM}	Output Common Mode Voltage		2.4	2.9	3.4	2.4	2.9	3.4	V	
V _{OP}	Output Voltage Swing		3.0	4.0		3.0	4.0		V _{P-P}	
I _{O-}	Output Sink Current		2.5	3.6		2.5	3.6		mA	
R _O	Output Resistance			20			20		Ω	
I _{CC}	Supply Current			18	24		18	24	mA	

Note 1: T_{J Max} = 150°C for the Molded DIP and SOIC, and 175°C for the Ceramic DIP.

Note 2: Ratings apply to ambient temperature at 25°C. Above this temperature, derate the 8L-Molded DIP at 7.5 mW/°C, the SO-8 at 6.5 mW/°C, the 14L-Molded DIP at 8.3 mW/°C, and the 14L-Ceramic DIP at 9.1 mW/°C.

Note 3: Gain Select leads G_{1A} and G_{1B} connected together for Gain 1 and Gain Select leads G_{2A} and G_{2B} connected together for Gain 2.

Note 4: Gain 2 not applicable to 8 lead device.

Equivalent Circuit

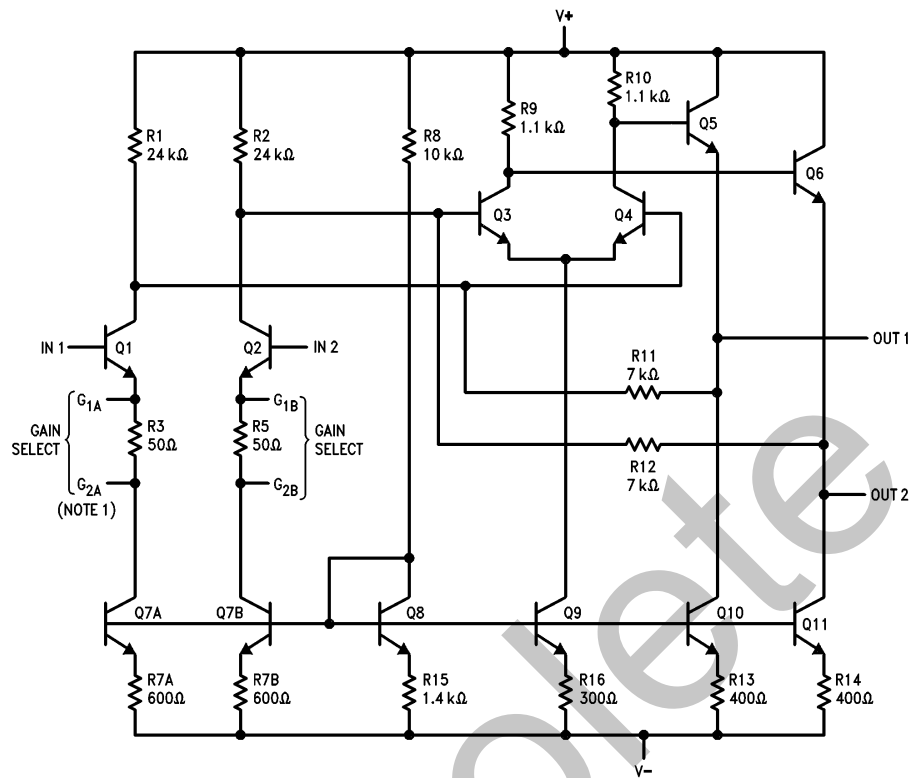

Note 1: G_{2A} and G_{2B} applies to 14 lead device only.

TL/H/10047-3

Typical Performance Curves

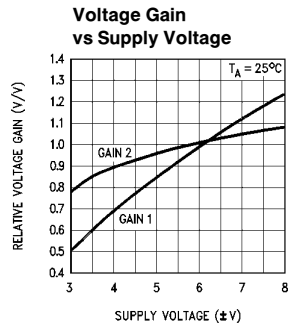
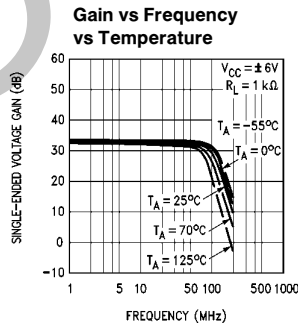
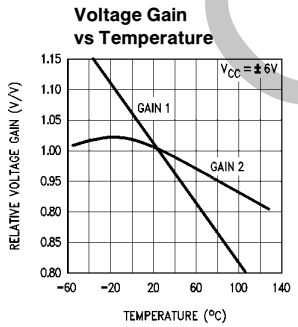
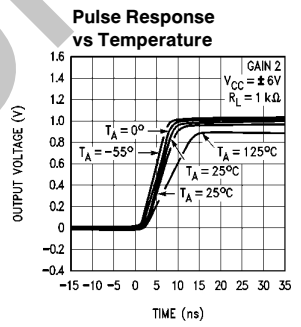
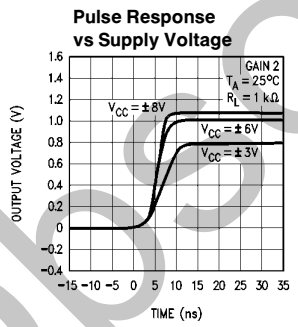
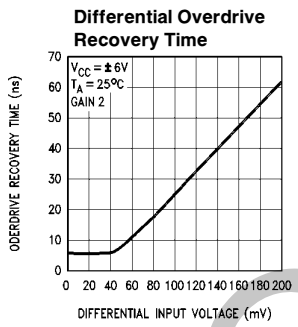
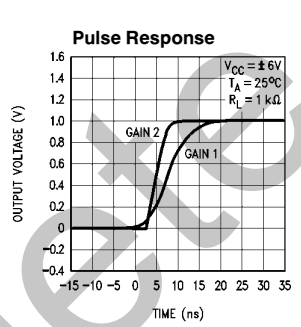
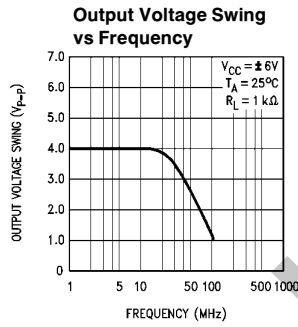
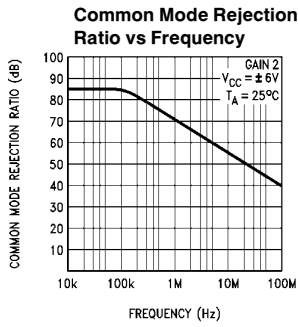
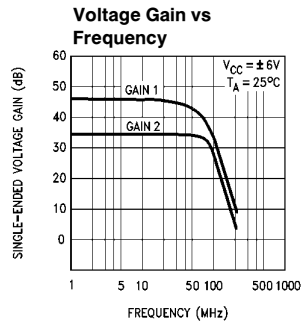
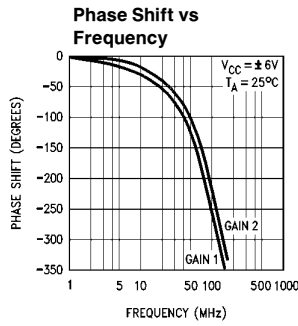
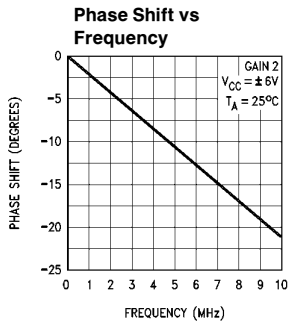

TL/H/10047-4

Typical Performance Curves (Continued)

Output Voltage and Current Swing vs Supply Voltage

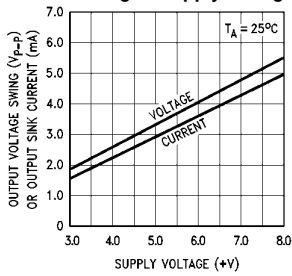

Voltage Gain Adjust Circuit

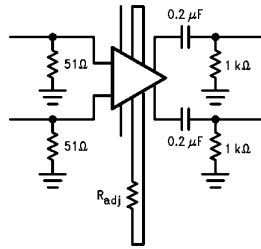

Voltage Gain vs R_{ADJ}

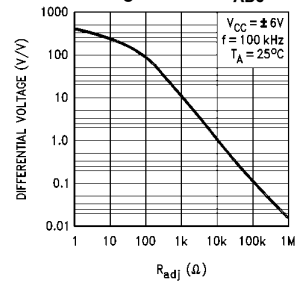

Output Voltage Swing vs Load Resistance

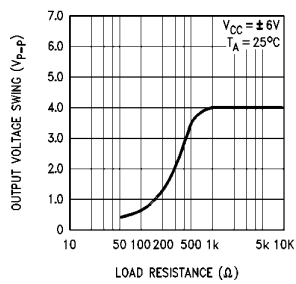

Input Noise Voltage vs Source Resistance

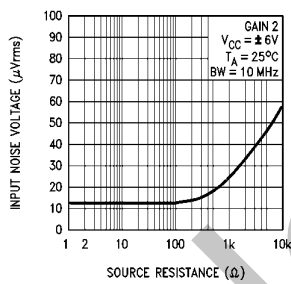

Supply Current vs Temperature

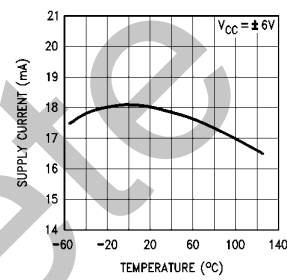

TL/H/10047-5

Supply Current vs Supply Voltage

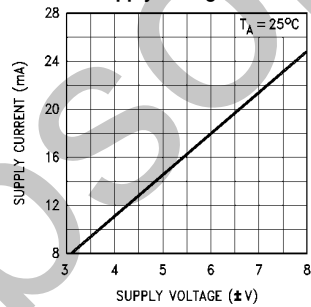

TL/H/10047-6

Obsolete

Physical Dimensions inches (millimeters)

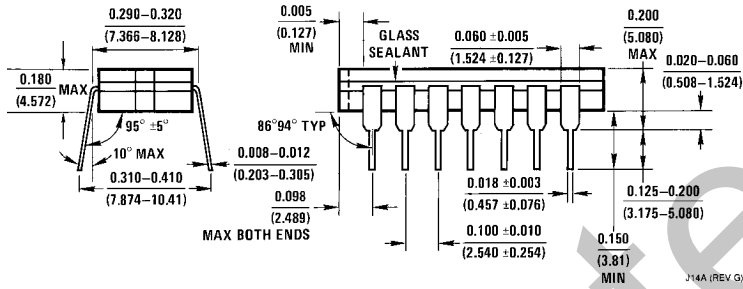
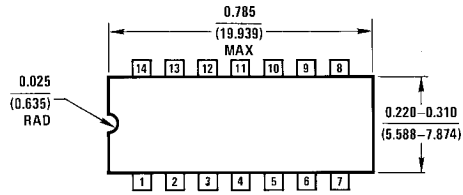

14-Lead Ceramic Dual-In-Line Package (J)
 Order Number μ A592DC or μ A592DM
 NS Package Number J14A

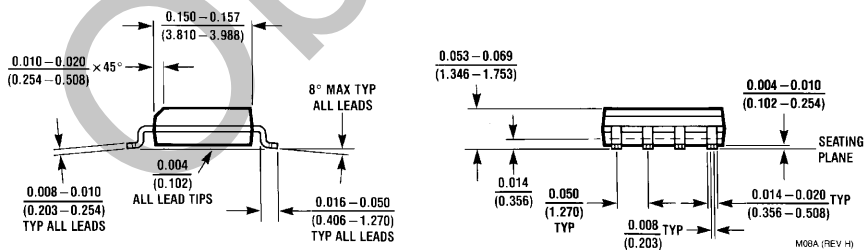
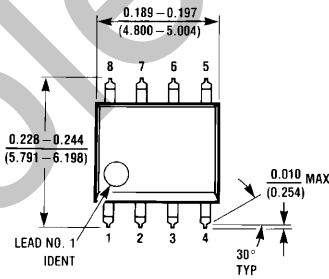

8-Lead Molded Surface Mount (M)
 Order Number μ A592SC
 NS Package Number M08A

Physical Dimensions inches (millimeters) (Continued)

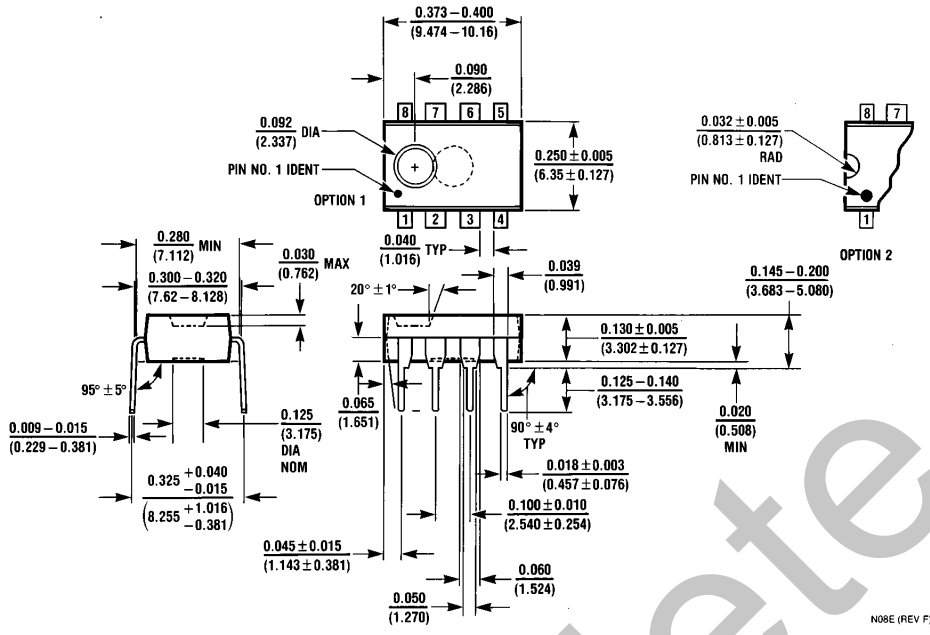

8-Lead Molded Dual-In-Line Package (N)
Order Number μA592TC
NS Package Number N08E

LIFE SUPPORT POLICY

NATIONAL'S PRODUCTS ARE NOT AUTHORIZED FOR USE AS CRITICAL COMPONENTS IN LIFE SUPPORT DEVICES OR SYSTEMS WITHOUT THE EXPRESS WRITTEN APPROVAL OF THE PRESIDENT OF NATIONAL SEMICONDUCTOR CORPORATION. As used herein:

1. Life support devices or systems are devices or systems which, (a) are intended for surgical implant into the body, or (b) support or sustain life, and whose failure to perform, when properly used in accordance with instructions for use provided in the labeling, can be reasonably expected to result in a significant injury to the user.
2. A critical component is any component of a life support device or system whose failure to perform can be reasonably expected to cause the failure of the life support device or system, or to affect its safety or effectiveness.



National Semiconductor Corporation
 1111 West Bardin Road
 Arlington, TX 76017
 Tel: 1(800) 272-9959
 Fax: 1(800) 737-7018

National Semiconductor Europe
 Fax: (+49) 0-180-530 85 86
 Email: cnjwge@tevm2.nsc.com
 Deutsch Tel: (+49) 0-180-530 85 85
 English Tel: (+49) 0-180-532 78 32
 Français Tel: (+49) 0-180-532 93 58
 Italiano Tel: (+49) 0-180-534 16 80

National Semiconductor Hong Kong Ltd.
 19th Floor, Straight Block,
 Ocean Centre, 5 Canton Rd.
 Tsimshatsui, Kowloon
 Hong Kong
 Tel: (852) 2737-1600
 Fax: (852) 2736-9960

National Semiconductor Japan Ltd.
 Tel: 81-043-299-2309
 Fax: 81-043-299-2408

National does not assume any responsibility for use of any circuitry described, no circuit patent licenses are implied and National reserves the right at any time without notice to change said circuitry and specifications.

IMPORTANT NOTICE

Texas Instruments Incorporated and its subsidiaries (TI) reserve the right to make corrections, modifications, enhancements, improvements, and other changes to its products and services at any time and to discontinue any product or service without notice. Customers should obtain the latest relevant information before placing orders and should verify that such information is current and complete. All products are sold subject to TI's terms and conditions of sale supplied at the time of order acknowledgment.

TI warrants performance of its hardware products to the specifications applicable at the time of sale in accordance with TI's standard warranty. Testing and other quality control techniques are used to the extent TI deems necessary to support this warranty. Except where mandated by government requirements, testing of all parameters of each product is not necessarily performed.

TI assumes no liability for applications assistance or customer product design. Customers are responsible for their products and applications using TI components. To minimize the risks associated with customer products and applications, customers should provide adequate design and operating safeguards.

TI does not warrant or represent that any license, either express or implied, is granted under any TI patent right, copyright, mask work right, or other TI intellectual property right relating to any combination, machine, or process in which TI products or services are used. Information published by TI regarding third-party products or services does not constitute a license from TI to use such products or services or a warranty or endorsement thereof. Use of such information may require a license from a third party under the patents or other intellectual property of the third party, or a license from TI under the patents or other intellectual property of TI.

Reproduction of TI information in TI data books or data sheets is permissible only if reproduction is without alteration and is accompanied by all associated warranties, conditions, limitations, and notices. Reproduction of this information with alteration is an unfair and deceptive business practice. TI is not responsible or liable for such altered documentation. Information of third parties may be subject to additional restrictions.

Resale of TI products or services with statements different from or beyond the parameters stated by TI for that product or service voids all express and any implied warranties for the associated TI product or service and is an unfair and deceptive business practice. TI is not responsible or liable for any such statements.

TI products are not authorized for use in safety-critical applications (such as life support) where a failure of the TI product would reasonably be expected to cause severe personal injury or death, unless officers of the parties have executed an agreement specifically governing such use. Buyers represent that they have all necessary expertise in the safety and regulatory ramifications of their applications, and acknowledge and agree that they are solely responsible for all legal, regulatory and safety-related requirements concerning their products and any use of TI products in such safety-critical applications, notwithstanding any applications-related information or support that may be provided by TI. Further, Buyers must fully indemnify TI and its representatives against any damages arising out of the use of TI products in such safety-critical applications.

TI products are neither designed nor intended for use in military/aerospace applications or environments unless the TI products are specifically designated by TI as military-grade or "enhanced plastic." Only products designated by TI as military-grade meet military specifications. Buyers acknowledge and agree that any such use of TI products which TI has not designated as military-grade is solely at the Buyer's risk, and that they are solely responsible for compliance with all legal and regulatory requirements in connection with such use.

TI products are neither designed nor intended for use in automotive applications or environments unless the specific TI products are designated by TI as compliant with ISO/TS 16949 requirements. Buyers acknowledge and agree that, if they use any non-designated products in automotive applications, TI will not be responsible for any failure to meet such requirements.

Following are URLs where you can obtain information on other Texas Instruments products and application solutions:

Products

Audio	www.ti.com/audio
Amplifiers	amplifier.ti.com
Data Converters	dataconverter.ti.com
DLP® Products	www.dlp.com
DSP	dsp.ti.com
Clocks and Timers	www.ti.com/clocks
Interface	interface.ti.com
Logic	logic.ti.com
Power Mgmt	power.ti.com
Microcontrollers	microcontroller.ti.com
RFID	www.ti-rfid.com
OMAP Mobile Processors	www.ti.com/omap
Wireless Connectivity	www.ti.com/wirelessconnectivity

Applications

Communications and Telecom	www.ti.com/communications
Computers and Peripherals	www.ti.com/computers
Consumer Electronics	www.ti.com/consumer-apps
Energy and Lighting	www.ti.com/energy
Industrial	www.ti.com/industrial
Medical	www.ti.com/medical
Security	www.ti.com/security
Space, Avionics and Defense	www.ti.com/space-avionics-defense
Transportation and Automotive	www.ti.com/automotive
Video and Imaging	www.ti.com/video

TI E2E Community Home Page

e2e.ti.com

Mailing Address: Texas Instruments, Post Office Box 655303, Dallas, Texas 75265
Copyright © 2011, Texas Instruments Incorporated