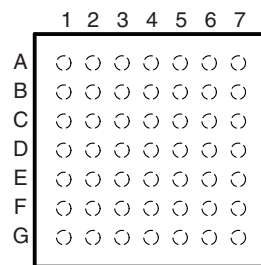
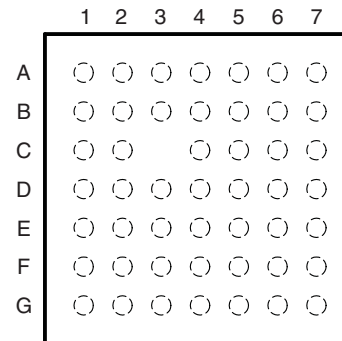

SDIO, UART, AND AUDIO VOLTAGE-TRANSLATION TRANSCEIVER

Check for Samples: [TWL1200](#)

FEATURES

- **Level Translator**
 - V_{CCA} and V_{CCB} Range of 1.1 V to 3.6 V
- **Seamlessly Bridges 1.8-V/2.6-V Digital-Switching Compatibility Gap Between 2.6-V processors and TI's Wi-Link (WL1271 and WL1273)**
- **Latch-Up Performance Exceeds 100 mA Per JESD 78, Class II**
- **ESD Protection Exceeds JESD 22**
 - 2500-V Human-Body Model (A114-B)
 - 250-V Machine Model (A115-A)
 - 1500-V Charged-Device Model (C101)

**YFF PACKAGE
(TOP VIEW)**

**ZQC PACKAGE
(TOP VIEW)**

BGA PACKAGE TERMINAL ASSIGNMENTS

| | 1 | 2 | 3 | 4 | 5 | 6 | 7 |
|----------|----------------|----------------|----------------|-----------------|----------------|----------------|----------------|
| A | SDIO_CLK(A) | SDIO_CMD(A) | AUDIO_CLK(A) | AUD_DIR | AUDIO_CLK(B) | SDIO_CMD(B) | SDIO_CLK(B) |
| B | SDIO_DATA3(A) | SDIO_DATA0(A) | AUDIO_F-SYN(A) | \overline{OE} | AUDIO_F-SYN(B) | SDIO_DATA0(B) | SDIO_DATA3(B) |
| C | SDIO_DATA2(A) | SDIO_DATA1(A) | | V_{CCA} | V_{CCB} | SDIO_DATA1(B) | SDIO_DATA2(B) |
| D | WLAN_EN(A) | WLAN_IRQ(A) | GND | V_{CCA} | V_{CCB} | WLAN_EN(B) | WLAN_IRQ(B) |
| E | CLK_REQ(A) | BT_EN(A) | GND | GND | GND | BT_EN(B) | CLK_REQ(B) |
| F | BT_UART_CTS(A) | BT_UART_RTS(A) | AUDIO_IN(A) | SLOW_CLK(B) | AUDIO_IN(B) | BT_UART_RTS(B) | BT_UART_CTS(B) |
| G | BT_UART_RX(A) | BT_UART_TX(A) | AUDIO_OUT(A) | SLOW_CLK(A) | AUDIO_OUT(B) | BT_UART_TX(B) | BT_UART_RX(B) |

WCS PACKAGE TERMINAL ASSIGNMENTS

| | 1 | 2 | 3 | 4 | 5 | 6 | 7 |
|----------|----------------|----------------|-------------------|-----------------|----------------|----------------|----------------|
| A | SDIO_CLK(A) | SDIO_CMD(A) | AUDIO_CLK(A) | AUD_DIR | AUDIO_CLK(B) | SDIO_CMD(B) | SDIO_CLK(B) |
| B | SDIO_DATA3(A) | SDIO_DATA0(A) | AUDIO_F-SYN(A) | \overline{OE} | AUDIO_F-SYN(B) | SDIO_DATA0(B) | SDIO_DATA3(B) |
| C | SDIO_DATA2(A) | SDIO_DATA1(A) | NC ⁽¹⁾ | V_{CCA} | V_{CCB} | SDIO_DATA1(B) | SDIO_DATA2(B) |
| D | WLAN_EN(A) | WLAN_IRQ(A) | GND | V_{CCA} | V_{CCB} | WLAN_EN(B) | WLAN_IRQ(B) |
| E | CLK_REQ(A) | BT_EN(A) | GND | GND | GND | BT_EN(B) | CLK_REQ(B) |
| F | BT_UART_CTS(A) | BT_UART_RTS(A) | AUDIO_IN(A) | SLOW_CLK(B) | AUDIO_IN(B) | BT_UART_RTS(B) | BT_UART_CTS(B) |
| G | BT_UART_RX(A) | BT_UART_TX(A) | AUDIO_OUT(A) | SLOW_CLK(A) | AUDIO_OUT(B) | BT_UART_TX(B) | BT_UART_RX(B) |

(1) NC – No internal connection



Please be aware that an important notice concerning availability, standard warranty, and use in critical applications of Texas Instruments semiconductor products and disclaimers thereto appears at the end of this data sheet.

DESCRIPTION/ORDERING INFORMATION

The TWL1200 is an 19-bit voltage translator specifically designed to seamlessly bridge the 1.8-V/2.6-V digital-switching compatibility gap between 2.6-V baseband and the TI Wi-Link-6 (WL1271/3). It is optimized for SDIO, UART, and audio functions. The TWL1200 has two supply-voltage pins, V_{CCA} and V_{CCB} , that can be operated over the full range of 1.1 V to 3.6 V. The TWL1200 enables system designers to easily interface applications processors or digital basebands to peripherals operating at a different I/O voltage levels, such as the TI Wi-Link-6 (WL1271/3) or other SDIO/memory cards.

The TWL1200 is offered in both 48-ball 0.5-mm ball grid array (BGA) and 49-bump 0.4-mm wafer chip scale package (WCSP) packages. Low static power consumption and small package size make the TWL1200 an ideal choice for mobile-phone applications.

ORDERING INFORMATION⁽¹⁾

| T_A | PACKAGE ⁽²⁾ | | ORDERABLE PART NUMBER | TOP-SIDE MARKING |
|---------------|---------------------------------------|---------------|-----------------------|------------------|
| –40°C to 85°C | BGA MicroStar Junior™ – ZQC (Pb-free) | Tape and reel | TWL1200ZQCR | YW200 |
| | WCSP™ – YFF (Pb-free) | Tape and reel | TWL1200YFFR | YW200 |

- (1) For the most current package and ordering information, see the Package Option Addendum at the end of this document, or see the TI web site at www.ti.com.
 (2) Package drawings, thermal data, and symbolization are available at www.ti.com/packaging.

TERMINAL FUNCTIONS

| TERMINAL | | | TYPE | DESCRIPTION |
|----------------|----------------|-----------------|-------|--|
| ZQC BALL NO. | YFF BUMP NO. | NAME | | |
| C4, D4 | C4, D4 | V_{CCA} | Power | A-side supply voltage (1.1 V to 3.6 V) |
| B2 | B2 | SDIO_DATA0(A) | I/O | Data bit 1 connected to baseband SDIO controller |
| C2 | C2 | SDIO_DATA1(A) | I/O | Data bit 2 connected to baseband SDIO controller |
| C1 | C1 | SDIO_DATA2(A) | I/O | Data bit 3 connected to baseband SDIO controller |
| B1 | B1 | SDIO_DATA3(A) | I/O | Data bit 4 connected to baseband SDIO controller |
| A2 | A2 | SDIO_CMD(A) | I/O | Command bit connected to baseband SDIO controller. Referenced to V_{CCA} . |
| A6 | A6 | SDIO_CMD(B) | I/O | Command bit connected to SD/SDIO peripheral. Includes a 15-k Ω pullup resistor to V_{CCB} . |
| D3, E3, E4, E5 | D3, E3, E4, E5 | GND | | Ground |
| B6 | B6 | SDIO_DATA0(B) | I/O | Data bit 1 connected to SD/SDIO peripheral |
| C6 | C6 | SDIO_DATA1(B) | I/O | Data bit 2 connected to SD/SDIO peripheral |
| C7 | C7 | SDIO_DATA2(B) | I/O | Data bit 3 connected to SD/SDIO peripheral |
| B7 | B7 | SDIO_DATA3(B) | I/O | Data bit 4 connected to SD/SDIO peripheral |
| A1 | A1 | SDIO_CLK(A) | I | Clock signal connected to baseband SDIO controller. Referenced to V_{CCA} . |
| A7 | A7 | SDIO_CLK(B) | O | Clock signal connected to SD/SDIO peripheral. Referenced to V_{CCB} ; drive strength = 8 mA |
| C5, D5 | C5, D5 | V_{CCB} | Pwr | B-side supply voltage (1.1 V to 3.6 V) |
| C3 | C3 | – | – | No ball (for ZQC) and No-Connect (for YFF) |
| B4 | B4 | \overline{OE} | I | Output enable (active low) |
| A4 | A4 | AUD_DIR | I | Direction control signal for AUDIO_CLK and AUDIO_F-SYNC signals |
| G3 | G3 | AUDIO_OUT(A) | O | Connected to baseband audio subsystem; drive strength = 4 mA |
| G5 | G5 | AUDIO_OUT(B) | I | Connected to Wi-Link-6 PCM subsystem |
| D1 | D1 | WLAN_EN(A) | I | Connected to baseband SDIO controller |
| D6 | D6 | WLAN_EN(B) | O | Connected to SD/SDIO peripheral; drive strength = 2 mA |
| G2 | G2 | BT_UART_TX(A) | O | Connected to baseband UART subsystem; drive strength = 8 mA |
| G6 | G6 | BT_UART_TX(B) | I | Connected to BT UART subsystem of Wi-Link-6 |
| D2 | D2 | WLAN_IRQ(A) | O | Connected to baseband SDIO controller; drive strength = 4 mA |

TERMINAL FUNCTIONS (continued)

| TERMINAL | | | TYPE | DESCRIPTION |
|--------------|--------------|----------------|------|---|
| ZQC BALL NO. | YFF BUMP NO. | NAME | | |
| D7 | D7 | WLAN_IRQ(B) | I | Connected to SD/SDIO peripheral |
| G4 | G4 | SLOW_CLK(A) | I | Low frequency 32-kHz clock connected to baseband device |
| F4 | F4 | SLOW_CLK(B) | O | Low frequency 32-kHz clock connected to Wi-Link-6 device; drive strength = 2 mA |
| G1 | G1 | BT_UART_RX(A) | I | Connected to baseband UART subsystem |
| G7 | G7 | BT_UART_RX(B) | O | Connected to BT UART subsystem of Wi-Link-6; drive strength = 8 mA |
| E1 | E1 | CLK_REQ(A) | O | Connected to baseband SDIO controller; drive strength = 4 mA |
| E7 | E7 | CLK_REQ(B) | I | Connected to SD/SDIO peripheral |
| F1 | F1 | BT_UART_CTS(A) | I | Connected to baseband UART subsystem |
| F3 | F3 | AUDIO_IN(A) | I | Connected to baseband audio subsystem |
| F5 | F5 | AUDIO_IN(B) | O | Connected to Wi-Link-6 PCM subsystem; drive strength = 4 mA |
| A3 | A3 | AUDIO_CLK(A) | I/O | Connected to baseband audio subsystem; drive strength = 4 mA |
| A5 | A5 | AUDIO_CLK(B) | I/O | Connected to Wi-Link-6 PCM subsystem; drive strength = 4 mA |
| E2 | E2 | BT_EN(A) | I | Connected to baseband UART subsystem |
| E6 | E6 | BT_EN(B) | O | Connected to BT UART subsystem of Wi-Link-6; drive strength = 2 mA |
| F7 | F7 | BT_UART_CTS(B) | O | Connected to BT UART subsystem of Wi-Link-6; drive strength = 4 mA |
| F2 | F2 | BT_UART_RTS(A) | O | Connected to baseband UART subsystem; drive strength = 4 mA |
| F6 | F6 | BT_UART_RTS(B) | I | Connected to BT UART subsystem of Wi-Link-6 |
| B3 | B3 | AUDIO_F-SYN(A) | I/O | Connected to baseband audio subsystem; drive strength = 4 mA |
| B5 | B5 | AUDIO_F-SYN(B) | I/O | Connected to Wi-Link-6 PCM subsystem; drive strength = 4 mA |

Table 1. FUNCTION TABLE

| CONTROL INPUTS | | OPERATION |
|------------------------|---------|---|
| $\overline{\text{OE}}$ | AUD_DIR | |
| H | X | All outputs are Hi-Z |
| L | H | AUDIO_CLK(A) to AUDIO_CLK(B) and AUDIO_F-SYNC(A) to AUDIO_F-SYNC(B) |
| L | L | AUDIO_CLK(B) to AUDIO_CLK(A) and AUDIO_F-SYNC(B) to AUDIO_F-SYNC(A) |

LOGIC DIAGRAM

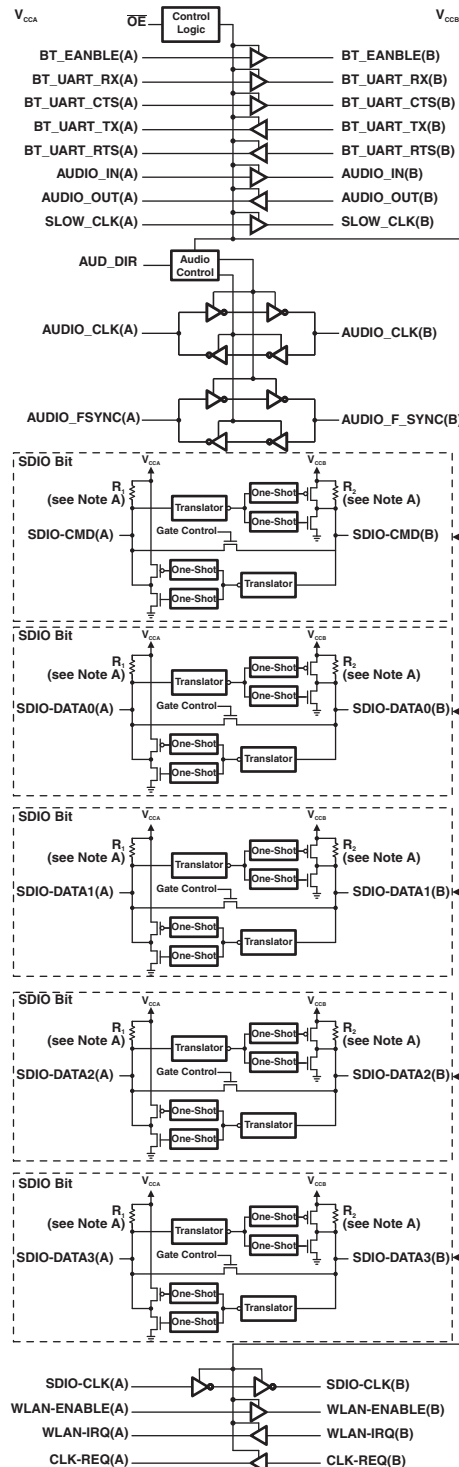

- A. R_1 and R_2 resistor values are determined based upon the logic level applied to the A port or B port as follows:
 R_1 and $R_2 = 25\text{ k}\Omega$ when a logic level low is applied to the A port or B port.
 R_1 and $R_2 = 4\text{ k}\Omega$ when a logic level high is applied to the A port or B port.
 R_1 and $R_2 = 70\text{ k}\Omega$ when the port is deselected (or in High-Z or 3-state).
- B. \overline{OE} controls all output buffers. When $\overline{OE} = \text{high}$, all outputs are Hi-Z.

TYPICAL APPLICATION BLOCK DIAGRAM

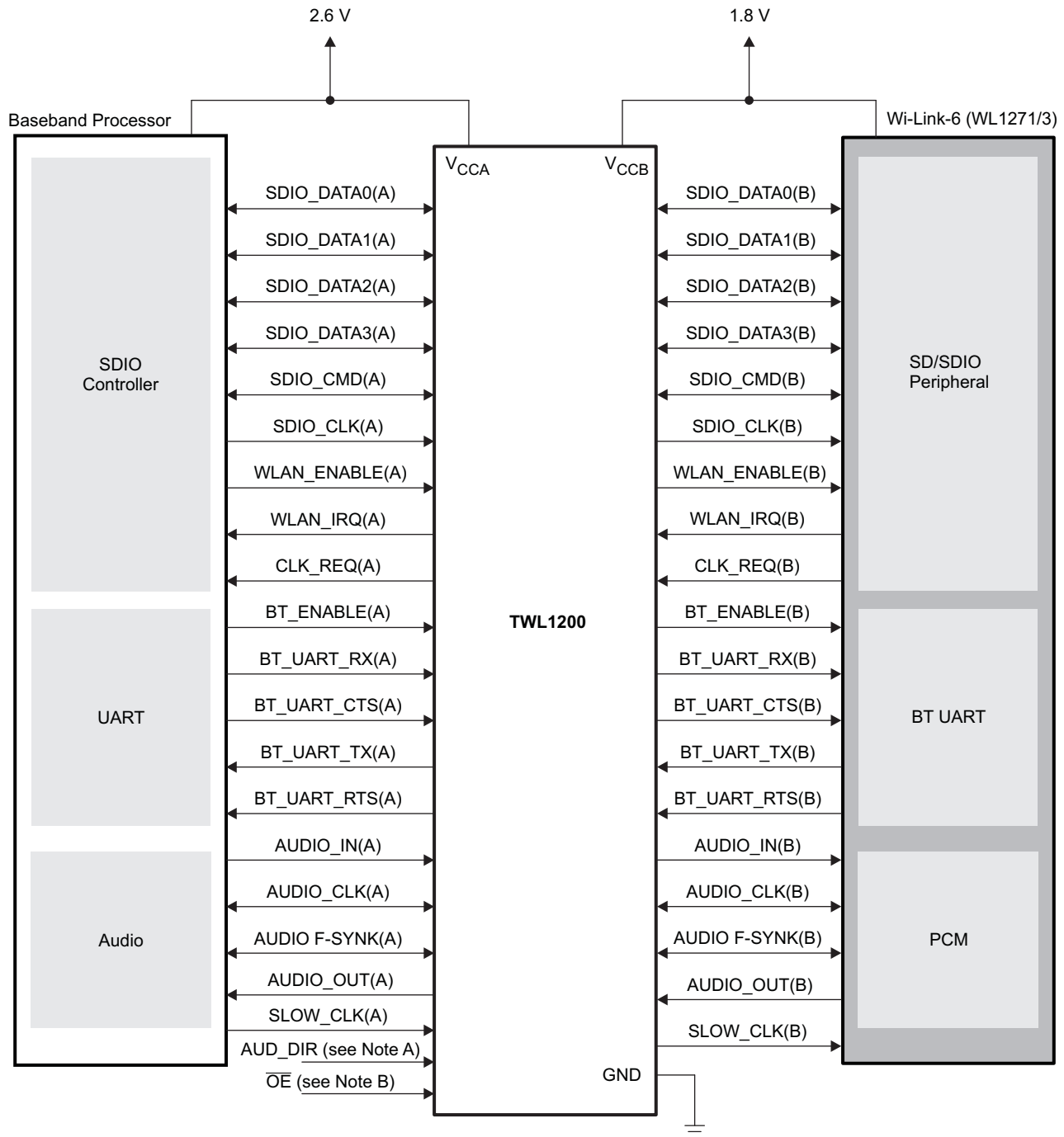

- A. AUD_DIR must be biased to determine audio direction (see Function Table for properly establishing the bias).
- B. \overline{OE} is an active-low pin that must be grounded to 0 V to enable operation of the TWL1200 device.

ABSOLUTE MAXIMUM RATINGS⁽¹⁾

over operating free-air temperature range (unless otherwise noted)

| | | MIN | MAX | UNIT | |
|------------------|---|--------------------|------|------|---|
| V _{CCA} | Supply voltage range | -0.5 | 4.6 | V | |
| V _{CCB} | Supply voltage range | -0.5 | 4.6 | V | |
| V _I | Input voltage range | I/O ports (A port) | -0.5 | 4.6 | V |
| | | I/O ports (B port) | -0.5 | 4.6 | |
| | | Control inputs | -0.5 | 4.6 | |
| V _O | Voltage range applied to any output in the high-impedance or power-off state ⁽²⁾ | A port | -0.5 | 4.6 | V |
| | | B port | -0.5 | 4.6 | |
| V _O | Voltage range applied to any output in the high or low state ⁽²⁾ | A port | -0.5 | 4.6 | V |
| | | B port | -0.5 | 4.6 | |
| I _{IK} | Input clamp current | V _I < 0 | -50 | mA | |
| I _{OK} | Output clamp current | V _O < 0 | -50 | mA | |
| I _O | Continuous output current | | ±50 | mA | |
| | Continuous current through V _{CCA} , V _{CCB} , or GND | | ±100 | mA | |
| T _{stg} | Storage temperature range | -65 | 150 | °C | |

- (1) Stresses beyond those listed under "absolute maximum ratings" may cause permanent damage to the device. These are stress ratings only, and functional operation of the device at these or any other conditions beyond those indicated under "recommended operating conditions" is not implied. Exposure to absolute-maximum-rated conditions for extended periods may affect device reliability.
- (2) The input and output voltage ratings may be exceeded if the input and output clamp-current ratings are observed.

THERMAL IMPEDANCE RATINGS

| | | | UNIT |
|-----------------|--|-------------|-------|
| θ _{JA} | Package thermal impedance ⁽¹⁾ | ZQC package | 171.6 |
| | | YFF package | 75 |

- (1) The package thermal impedance is calculated in accordance with JESD 51-7.

RECOMMENDED OPERATING CONDITIONS⁽¹⁾

| | | | V_{CCI} | V_{CCO} | MIN | MAX | UNIT |
|---------------------|------------------------------------|-------------------------------|----------------|------------------|-----------------------|-----------------------|------|
| V_{CCA} | Supply voltage | | | | 1.1 | 3.6 | V |
| V_{CCB} | Supply voltage | | | | 1.1 | 3.6 | V |
| V_{IH} | High-level input voltage | Buffer type | 1.1 V to 3.6 V | 1.1 V to 3.6 V | $V_{CCI} \times 0.65$ | 3.6 | V |
| | | \overline{OE} and AUD_DIR | | | $V_{CCA} \times 0.65$ | 3.6 | |
| V_{IH} | High-level input voltage | Switch type | 1.1 V to 3.6 V | 1.1 V to 3.6 V | $V_{CCI} - 0.2$ | V_{CCI} | V |
| V_{IL} | Low-level input voltage | Buffer type and Control Logic | 1.1 V to 3.6 V | 1.1 V to 3.6 V | 0 | $V_{CCI} \times 0.35$ | V |
| | | \overline{OE} and AUD_DIR | | | 0 | $V_{CCA} \times 0.35$ | |
| $V_{IL}^{(2)}$ | Low-level input voltage | Switch type | 1.1 V to 3.6 V | 1.1 V to 3.6 V | 0 | 0.15 | V |
| V_I | Input voltage | | | | 0 | 3.6 | V |
| V_O | Output voltage | Active state | | | 0 | V_{CCO} | V |
| | | 3-state | | | 0 | 3.6 | |
| I_{OH} | High-level output current | | | 1.1 V to 1.3 V | | -0.5 | mA |
| | | | | 1.4 V to 1.6 V | | -1 | |
| | | | | 1.65 V to 1.95 V | | -2 | |
| | | | | 2.3 V to 2.7 V | | -4 | |
| | | | | 3 V to 3.6 V | | -8 | |
| I_{OL} | Low-level output current | | | 1.1 V to 1.3 V | | 0.5 | mA |
| | | | | 1.4 V to 1.6 V | | 1 | |
| | | | | 1.65 V to 1.95 V | | 2 | |
| | | | | 2.3 V to 2.7 V | | 4 | |
| | | | | 3 V to 3.6 V | | 8 | |
| $\Delta t/\Delta v$ | Input transition rise or fall rate | | | | | 5 | ns/V |
| T_A | Operating free-air temperature | | | | -40 | 85 | °C |

(1) All unused data inputs of the device must be held at V_{CCI} or GND to ensure proper device operation. Refer to the TI application report, *Implications of Slow or Floating CMOS Inputs*, literature number SCBA004.

(2) Note, the max V_{IL} value is provided to ensure that a valid V_{OL} is maintained. The V_{OL} value is the V_{IL} + the voltage-drop across the pass-gate transistor.

ELECTRICAL CHARACTERISTICS

over recommended operating free-air temperature range (unless otherwise noted)

| PARAMETER | | TEST CONDITIONS | V _{CCA} | V _{CCB} | MIN | TYP ⁽¹⁾ | MAX | UNIT |
|---|---|---|--|------------------|------------------------|--------------------|------|------|
| V _{OH} | A port (Buffer-type output, 8-mA drive) | I _{OH} = -100 µA | 1.1 V to 3.6 V | 1.1 V to 3.6 V | V _{CC0} - 0.2 | | | V |
| | | | 1.65 V | 1.65 V | 1.2 | | | |
| | | | 2.5 V | 2.5 V | 1.97 | | | |
| | A port (Buffer-type output, 4-mA drive) | I _{OH} = -100 µA | 1.1 V to 3.6 V | 1.1 V to 3.6 V | V _{CC0} - 0.2 | | | |
| | | | 1.65 V | 1.65 V | 1.2 | | | |
| | | | 2.5 V | 2.5 V | 1.97 | | | |
| V _{OH} | A port (Switch-type outputs) | I _{OH} = -20 µA | 1.65 V | 1.65 V | 1.5 | | | V |
| | | | 2.5 V | 2.5 V | 2.3 | | | |
| V _{OL} | A port (Buffer-type output, 8-mA drive) | I _{OL} = 100 µA | 1.1 V to 3.6 V | 1.1 V to 3.6 V | | | 0.2 | V |
| | | | 1.65 V | 1.65 V | | | 0.45 | |
| | | | 2.5 V | 2.5 V | | | 0.55 | |
| | A port (Buffer-type output, 4-mA drive) | I _{OL} = 100 µA | 1.1 V to 3.6 V | 1.1 V to 3.6 V | | | 0.2 | |
| | | | 1.65 V | 1.65 V | | | 0.45 | |
| | | | 2.5 V | 2.5 V | | | 0.55 | |
| V _{OL} | A port (Switch-type outputs) | I _{OL} = 220 µA, V _{IN} = 0.15 V | 1.65 V | 1.65 V | | | 0.45 | V |
| | | | 2.5 V | 2.5 V | | | 0.55 | |
| V _{OH} | B port (Buffer-type output, 8-mA drive) | I _{OH} = -100 µA | 1.1 V to 3.6 V | 1.1 V to 3.6 V | V _{CC0} - 0.2 | | | V |
| | | | 1.65 V | 1.65 V | 1.2 | | | |
| | | | 2.5 V | 2.5 V | 1.97 | | | |
| | B port (Buffer-type output, 4-mA drive) | I _{OH} = -100 µA | 1.1 V to 3.6 V | 1.1 V to 3.6 V | V _{CC0} - 0.2 | | | |
| | | | 1.65 V | 1.65 V | 1.2 | | | |
| | | | 2.5 V | 2.5 V | 1.97 | | | |
| | B port (Buffer-type output, 2-mA drive) | I _{OH} = -100 µA | 1.1 V to 3.6 V | 1.1 V to 3.6 V | V _{CC0} - 0.2 | | | |
| | | | 1.65 V | 1.65 V | 1.2 | | | |
| | B port (Switch-type outputs) | I _{OH} = -20 µA | 1.65 V | 1.65 V | 1.5 | | | |
| | | | 2.5 V | 2.5 V | 2.3 | | | |
| | | | 1.65 V | 1.65 V | 1.5 | | | |
| | V _{OL} | B port (Buffer-type output, 8-mA drive) | I _{OL} = 100 µA | 1.1 V to 3.6 V | 1.1 V to 3.6 V | | | |
| 1.65 V | | | | 1.65 V | | | 0.45 | |
| 2.5 V | | | | 2.5 V | | | 0.55 | |
| B port (Buffer-type output, 4-mA drive) | | I _{OL} = 100 µA | 1.1 V to 3.6 V | 1.1 V to 3.6 V | | | 0.2 | |
| | | | 1.65 V | 1.65 V | | | 0.45 | |
| | | | 2.5 V | 2.5 V | | | 0.55 | |
| B port (Buffer-type output, 2-mA drive) | | I _{OL} = 100 µA | 1.1 V to 3.6 V | 1.1 V to 3.6 V | | | 0.2 | |
| | | | 1.65 V | 1.65 V | | | 0.45 | |
| B port (Switch-type outputs) | | I _{OL} = 220 µA, V _{IN} = 0.15 V | 1.65 V | 1.65 V | | | 0.45 | |
| | | | 2.5 V | 2.5 V | | | 0.55 | |
| | | | 2.5 V | 2.5 V | | | 0.55 | |
| I _I | | | V _I = V _{CCA} or GND | 1.1 V to 3.6 V | 1.1 V to 3.6 V | | | ±1 |
| | 3.6 V | | | 0 V | | | 15 | |
| | 0 V | | | 3.6 V | | | -12 | |
| I _{CCA} | | Switch-type I/O are open and all other inputs are biased at either V _{CC} or GND | 1.1 V to 3.6 V | 1.1 V to 3.6 V | | | 15 | µA |
| | | | 3.6 V | 0 V | | | 14 | |
| | | | 0 V | 3.6 V | | | -12 | |

(1) All typical values are at T_A = 25°C.

ELECTRICAL CHARACTERISTICS (continued)

over recommended operating free-air temperature range (unless otherwise noted)

| PARAMETER | | TEST CONDITIONS | V _{CCA} | V _{CCB} | MIN | TYP ⁽¹⁾ | MAX | UNIT |
|-------------------------------------|----------------------------------|---|------------------|------------------|-----|--------------------|-----|------|
| I _{CCB} | | Switch-type I/O are open and all other inputs are biased at either V _{CC} or GND | 1.1 V to 3.6 V | 1.1 V to 3.6 V | | | 15 | μA |
| | | | 3.6 V | 0 V | | | -12 | |
| | | | 0 V | 3.6 V | | | 14 | |
| I _{CCA} + I _{CCB} | | V _I = V _{CCI} or GND, I _O = 0 | 1.1 V to 3.6 V | 1.1 V to 3.6 V | | | 30 | μA |
| C _{IO} | Auto-Dir (SDIO lines) | V _I = V _{CCI} | | | | | 5.5 | pF |
| | Bi-Dir buffer | V _I = V _{CCX} or GND | | | | | 4.5 | |
| C _I | AUD_DIR / $\overline{\text{OE}}$ | V _I = V _{CCA} or GND | | | | | 4 | pF |
| | Buffer | V _I = V _{CCX} or GND | | | | | 4 | |
| C _O | 2-mA buffer | V _I = V _{CCX} or GND | | | | | 5 | pF |
| | 4-mA buffer | V _I = V _{CCX} or GND | | | | | 5 | |
| | 8-mA buffer | V _I = V _{CCX} or GND | | | | | 6 | |

OUTPUT DRIVE STRENGTH

| 2 mA | 4 mA | 8 mA |
|-------------|-----------------|---------------|
| WLAN_EN(B) | AUDIO_OUT(A) | SDIO_CLK(B) |
| SLOW_CLK(B) | WLAN_IRQ(A) | BT_UART_TX(A) |
| BT_EN(B) | CLK_REQ(A) | BT_UART_RX(B) |
| | AUDIO_IN(B) | |
| | AUDIO_CLK(A) | |
| | BT_UART_CTS(B) | |
| | BT_UART_RTS(A) | |
| | AUDIO_F-SYNC(A) | |

TIMING REQUIREMENTS

$V_{CCA} = 2.5\text{ V} \pm 0.2\text{ V}$

over recommended operating free-air temperature range (unless otherwise noted)

| | | | $V_{CCB} = 1.8\text{ V} \pm 0.15\text{ V}$ | | UNIT |
|----------------------|------------|--------------------|--|-----|---------------|
| | | | MIN | MAX | |
| Data rate | SDIO_CMD | Push-pull driving | 60 | | Mbps |
| | | Open-drain driving | 1 | | |
| | SDIO_CLK | Push-pull driving | 50 | | MHz |
| | SDIO_DATAx | | 60 | | Mbps |
| t_w Pulse duration | SDIO_CMD | Push-pull driving | 17 | | ns |
| | | Open-drain driving | 1 | | μs |
| | SDIO_CLK | Push-pull driving | 10 | | ns |
| | SDIO_DATAx | | 17 | | ns |

TIMING REQUIREMENTS

$V_{CCA} = 3.3\text{ V} \pm 0.3\text{ V}$

over recommended operating free-air temperature range (unless otherwise noted)

| | | | $V_{CCB} = 1.8\text{ V} \pm 0.15\text{ V}$ | | UNIT |
|----------------------|------------|--------------------|--|-----|---------------|
| | | | MIN | MAX | |
| Data rate | SDIO_CMD | Push-pull driving | 60 | | Mbps |
| | | Open-drain driving | 1 | | |
| | SDIO_CLK | Push-pull driving | 50 | | MHz |
| | SDIO_DATAx | | 60 | | Mbps |
| t_w Pulse duration | SDIO_CMD | Push-pull driving | 17 | | ns |
| | | Open-drain driving | 1 | | μs |
| | SDIO_CLK | Push-pull driving | 10 | | ns |
| | SDIO_DATAx | | 17 | | ns |

SWITCHING CHARACTERISTICS

$V_{CCA} = 2.5 \text{ V} \pm 0.2 \text{ V}$

over recommended operating free-air temperature range (unless otherwise noted)

| PARAMETER | FROM (INPUT) | TO (OUTPUT) | TEST CONDITIONS | $V_{CCB} = 1.8 \text{ V} \pm 0.15 \text{ V}$ | | UNIT |
|---------------|----------------------------|----------------------------|-----------------------------|--|------|---------------|
| | | | | MIN | MAX | |
| t_{pd} | SDIO_CMD(A) | SDIO_CMD(B) | Push-pull driving | | 7 | ns |
| | | | Open-drain driving (H-to-L) | 1.1 | 7 | |
| | | | Open-drain driving (L-to-H) | 30 | 510 | |
| | SDIO_CMD(B) | SDIO_CMD(A) | Push-pull driving | | 7 | |
| | | | Open-drain driving (H-to-L) | 1 | 7.5 | |
| | | | Open-drain driving (L-to-H) | 30 | 515 | |
| | SDIO_CLK(A) | SDIO_CLK(B) | Push-pull driving | 1 | 6.5 | |
| | SDIO_DATAx(A) | SDIO_DATAx(B) | Push-pull driving | 1 | 7 | |
| | SDIO_DATAx(B) | SDIO_DATAx(A) | | 1 | 7 | |
| | | Buffered input | 2-mA drive strength output | Push-pull driving | 1 | |
| | Buffered input | 4-mA drive strength output | Push-pull driving | 1 | 7 | |
| | Buffered input | 8-mA drive strength output | Push-pull driving | 1 | 6.5 | |
| t_{en} | OE | 2-mA drive strength output | Push-pull driving | | 16 | ns |
| | | 4-mA drive strength output | Push-pull driving | | 19 | |
| | | 8-mA drive strength output | Push-pull driving | | 18 | |
| | | Switch-type output | Push-pull driving | | 1 | μs |
| t_{dis} | OE | 2-mA drive strength output | Push-pull driving | | 17 | ns |
| | | 4-mA drive strength output | Push-pull driving | | 16.5 | |
| | | 8-mA drive strength output | Push-pull driving | | 16 | |
| | | Switch-type outputs | Push-pull driving | | 1 | μs |
| t_{rA} | SDIO_CMD(A) rise time | | Push-pull driving | 1 | 5 | ns |
| | | | Open-drain driving | 15 | 420 | |
| | | SDIO_DATAx(A) rise time | | Push-pull driving | 1 | 4.7 |
| t_{rB} | SDIO_CMD(B) rise time | | Push-pull driving | 1 | 9.7 | ns |
| | | | Open-drain driving | 15 | 420 | |
| | SDIO_CLK(B) rise time | | Push-pull driving | 0.5 | 6 | |
| | | SDIO_DATAx(B) rise time | | 1 | 9.7 | |
| t_{fA} | SDIO_CMD(A) fall time | | Push-pull driving | 0.7 | 8.3 | ns |
| | | | Open-drain driving | 1.6 | 8.3 | |
| | | SDIO_DATAx(A) fall time | | 1 | 8.3 | |
| t_{fB} | SDIO_CMD(B) fall time | | Push-pull driving | 1 | 9.9 | ns |
| | | | Open-drain driving | 1.6 | 10.9 | |
| | SDIO_CLK(B) fall time | | Push-pull driving | 0.5 | 5.3 | |
| | | SDIO_DATAx(B) fall time | | 1 | 9.9 | |
| $t_{sk(O)}$ | SDIO Ch-A to Ch-B skew | | Push-pull driving | | 0.4 | ns |
| | SDIO Ch-B to Ch-A skew | | Push-pull driving | | 0.4 | |
| | SDIO channel-to-clock skew | | Push-pull driving | | 1.3 | |
| Max data rate | SDIO_CMD | | Push-pull driving | | 60 | Mbps |
| | | | Open-drain driving | | 1 | |
| | SDIO_CLK | | Push-pull driving | | 50 | MHz |
| SDIO_DATAx | | Push-pull driving | | 60 | Mbps | |

SWITCHING CHARACTERISTICS

V_{CCA} = 3.3 V ± 0.3 V

over recommended operating free-air temperature range (unless otherwise noted)

| PARAMETER | FROM (INPUT) | TO (OUTPUT) | TEST CONDITIONS | V _{CCB} = 1.8 V ± 0.15 V | | UNIT |
|--------------------|----------------------------|----------------------------|-----------------------------|-----------------------------------|------|------|
| | | | | MIN | MAX | |
| t _{pd} | SDIO_CMD(A) | SDIO_CMD(B) | Push-pull driving | | 7 | ns |
| | | | Open-drain driving (H-to-L) | 1.1 | 7 | |
| | | | Open-drain driving (L-to-H) | 30 | 510 | |
| | SDIO_CMD(B) | SDIO_CMD(A) | Push-pull driving | | 7 | |
| | | | Open-drain driving (H-to-L) | 1 | 7.5 | |
| | | | Open-drain driving (L-to-H) | 30 | 515 | |
| | SDIO_CLK(A) | SDIO_CLK(B) | Push-pull driving | 1 | 6.5 | |
| | SDIO_DATAx(A) | SDIO_DATAx(B) | Push-pull driving | 1 | 7 | |
| | SDIO_DATAx(B) | SDIO_DATAx(A) | | 1 | 7 | |
| | Buffered input | 2-mA drive strength output | Push-pull driving | 1 | 7.6 | |
| Buffered input | 4-mA drive strength output | Push-pull driving | 1 | 7 | | |
| Buffered -nput | 8-mA drive strength output | Push-pull driving | 1 | 6.5 | | |
| t _{en} | OE | 2-mA drive strength output | Push-pull driving | | 16 | ns |
| | | 4-mA drive strength output | Push-pull driving | | 19 | |
| | | 8-mA drive strength output | Push-pull driving | | 19 | |
| | | Switch-type output | Push-pull driving | | 1 | µs |
| t _{dis} | OE | 2-mA drive strength output | Push-pull driving | | 17 | ns |
| | | 4-mA drive strength output | Push-pull driving | | 16 | |
| | | 8-mA drive strength output | Push-pull driving | | 16 | |
| | | Switch-type output | Push-pull driving | | 1 | µs |
| t _{rA} | SDIO_CMD(A) rise time | | Push-pull driving | 1 | 4.25 | ns |
| | SDIO_DATAx(A) rise time | | Open-drain driving | 15 | 420 | |
| t _{rB} | SDIO_CMD(B) rise time | | Push-pull driving | 1 | 9.5 | ns |
| | SDIO_CLK(B) rise time | | Open-drain driving | 15 | 420 | |
| | SDIO_DATAx(B) rise time | | Push-pull driving | 0.5 | 5.9 | |
| t _{fA} | SDIO_CMD(A) fall time | | Push-pull driving | 0.7 | 8.2 | ns |
| | SDIO_DATAx(A) fall time | | Open-drain driving | 1.6 | 8.2 | |
| t _{fB} | SDIO_CMD(B) fall time | | Push-pull driving | 1 | 9.2 | ns |
| | SDIO_CLK(B) fall time | | Open-drain driving | 1.6 | 10.8 | |
| | SDIO_DATAx(B) fall time | | Push-pull driving | 0.5 | 5.2 | |
| t _{sk(O)} | SDIO Ch-A to Ch-B skew | | Push-pull driving | | 0.4 | ns |
| | SDIO Ch-B to Ch-A skew | | Push-pull driving | | 0.4 | |
| | SDIO Channel-to-Clock skew | | Push-pull driving | | 1.3 | |
| Max data rate | SDIO_CMD | | Push-pull driving | | 60 | Mbps |
| | SDIO_CMD | | Open-drain driving | | 1 | |
| | SDIO_CLK | | Push-pull driving | | 50 | MHz |
| SDIO_DATAx | | | | 60 | Mbps | |

OPERATING CHARACTERISTICS
 $T_A = 25^\circ\text{C}$

| PARAMETER | | | TEST CONDITIONS | $V_{CCA} = V_{CCB} = 1.8\text{ V}$ | $V_{CCA} = V_{CCB} = 2.5\text{ V}$ | UNIT |
|---------------|----------|----------------------|---|------------------------------------|------------------------------------|------|
| DATAx and CMD | Enabled | C_{pd} input side | $C_L = 0,$ $f = 10\text{ MHz},$ $t_r = t_f = 1\text{ ns}$ | 18.3 | 20.3 | pF |
| | | C_{pd} output side | | 18.25 | 19.52 | |
| | Disabled | C_{pd} input side | | 0.8 | 0.8 | |
| | | C_{pd} output side | | 0.1 | 0.1 | |
| Clock | Enabled | C_{pd} input side | $C_L = 0,$ $f = 10\text{ MHz},$ $t_r = t_f = 1\text{ ns}$ | 0.6 | 0.9 | pF |
| | | C_{pd} output side | | 8.8 | 10.1 | |
| | Disabled | C_{pd} input side | | 0.1 | 0.1 | |
| | | C_{pd} output side | | 0.1 | 0.1 | |
| 2-mA buffer | Enabled | C_{pd} input side | $C_L = 0,$ $f = 10\text{ MHz},$ $t_r = t_f = 1\text{ ns}$ | 0.6 | 1.0 | pF |
| | | C_{pd} output side | | 7.1 | 7.9 | |
| | Disabled | C_{pd} input side | | 0.1 | 0.1 | |
| | | C_{pd} output side | | 0.1 | 0.1 | |
| 4-mA buffer | Enabled | C_{pd} input side | $C_L = 0,$ $f = 10\text{ MHz},$ $t_r = t_f = 1\text{ ns}$ | 0.6 | 1.0 | pF |
| | | C_{pd} output side | | 7.6 | 8.6 | |
| | Disabled | C_{pd} input side | | 0.1 | 0.1 | |
| | | C_{pd} output side | | 0.1 | 0.1 | |
| 8-mA buffer | Enabled | C_{pd} input side | $C_L = 0,$ $f = 10\text{ MHz},$ $t_r = t_f = 1\text{ ns}$ | 0.6 | 1.0 | pF |
| | | C_{pd} output side | | 8.8 | 10.1 | |
| | Disabled | C_{pd} input side | | 0.1 | 0.1 | |
| | | C_{pd} output side | | 0.1 | 0.1 | |
| 4-mA I/O | Enabled | C_{pd} input side | $C_L = 0,$ $f = 10\text{ MHz},$ $t_r = t_f = 1\text{ ns}$ | 0.6 | 0.95 | pF |
| | | C_{pd} output side | | 8.2 | 9.1 | |
| | Disabled | C_{pd} input side | | 0.1 | 0.1 | |
| | | C_{pd} output side | | 0.1 | 0.1 | |

TYPICAL CHARACTERISTICS

**LOW-LEVEL OUTPUT VOLTAGE
vs
LOW-LEVEL OUTPUT CURRENT**

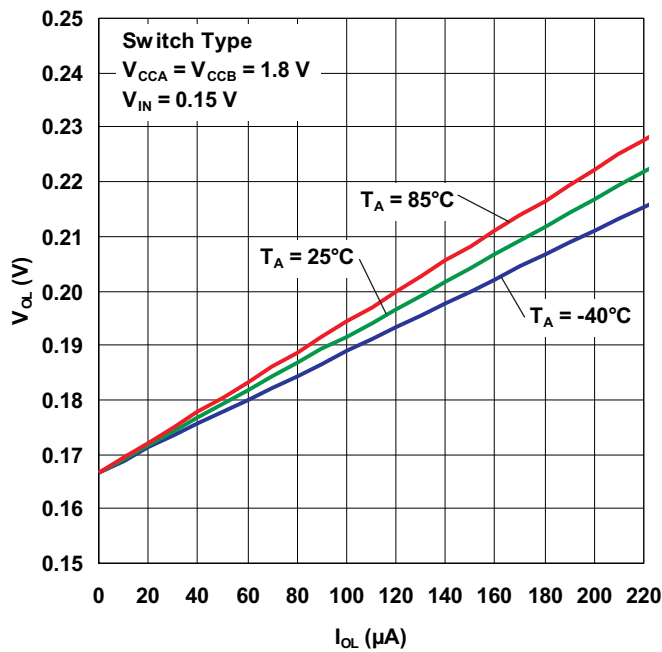

Figure 1.

**LOW-LEVEL OUTPUT VOLTAGE
vs
LOW-LEVEL OUTPUT CURRENT**

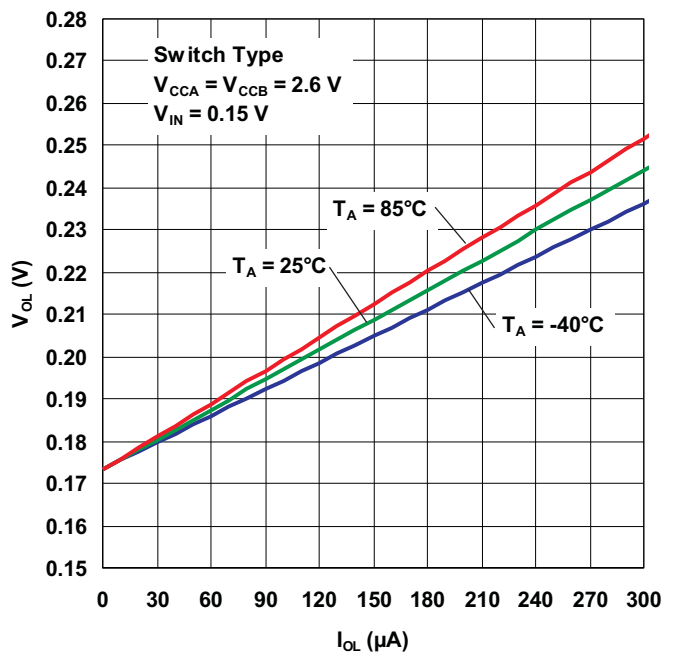

Figure 2.

**LOW-LEVEL OUTPUT VOLTAGE
vs
LOW-LEVEL OUTPUT CURRENT**

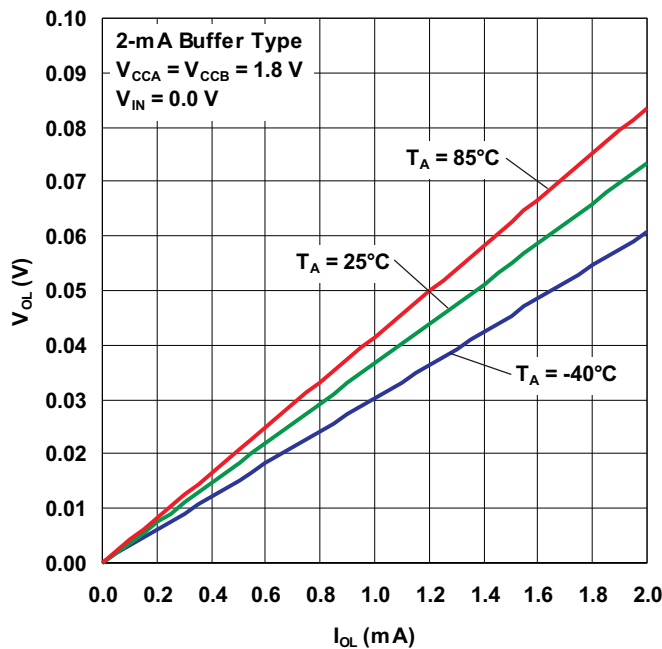

Figure 3.

**LOW-LEVEL OUTPUT VOLTAGE
vs
LOW-LEVEL OUTPUT CURRENT**

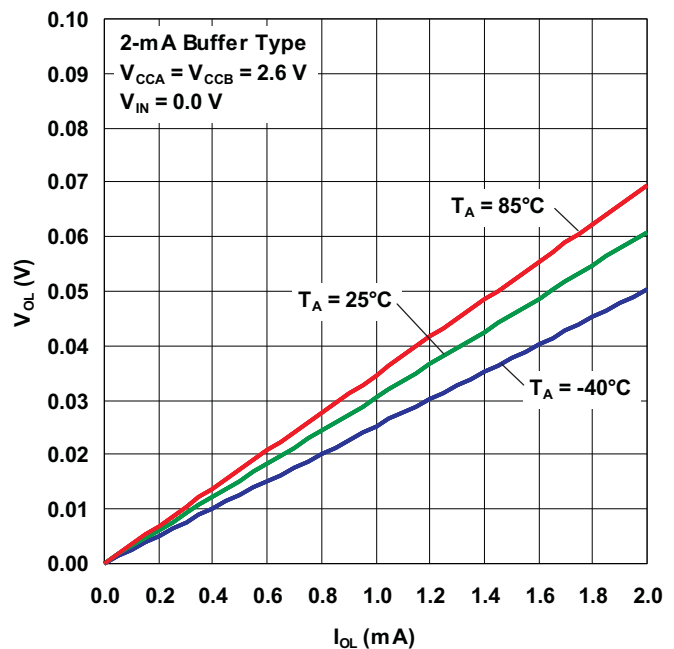

Figure 4.

TYPICAL CHARACTERISTICS (continued)

LOW-LEVEL OUTPUT VOLTAGE
VS
LOW-LEVEL OUTPUT CURRENT

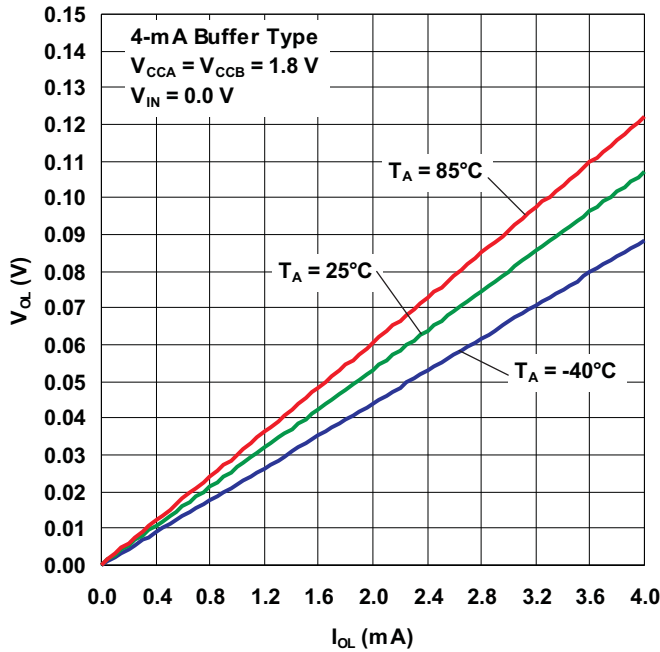

Figure 5.

LOW-LEVEL OUTPUT VOLTAGE
VS
LOW-LEVEL OUTPUT CURRENT

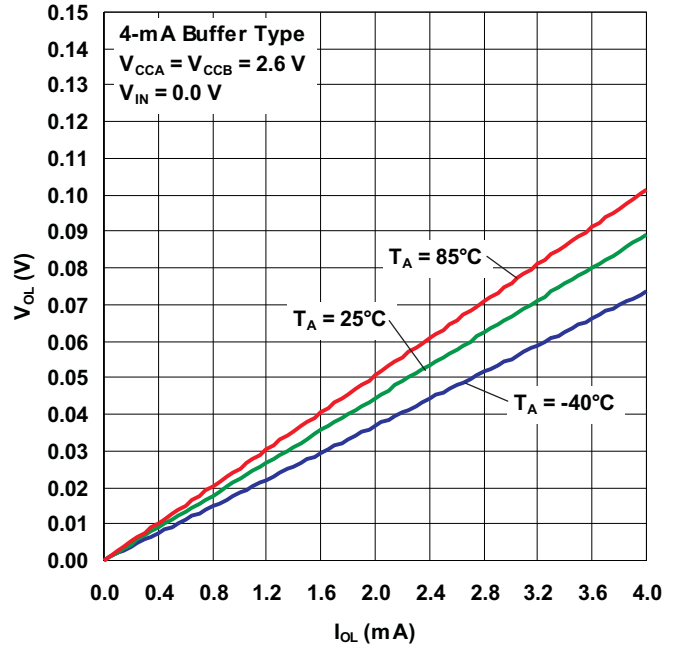

Figure 6.

LOW-LEVEL OUTPUT VOLTAGE
VS
LOW-LEVEL OUTPUT CURRENT

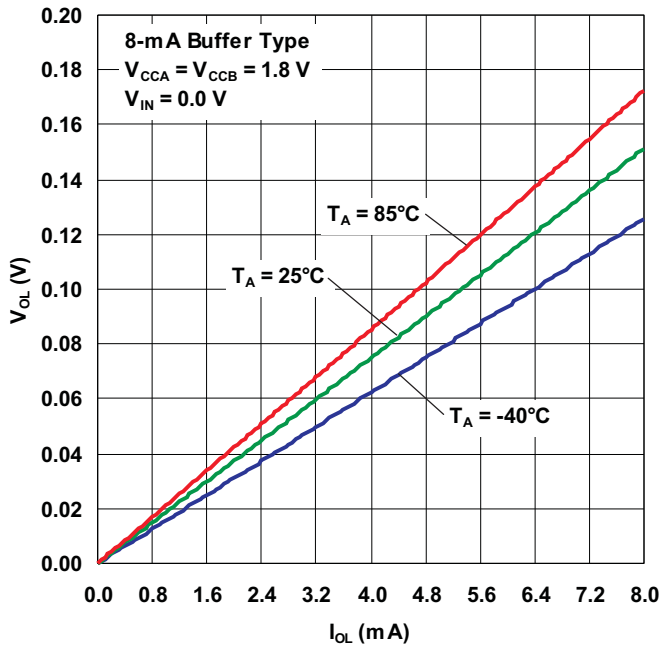

Figure 7.

LOW-LEVEL OUTPUT VOLTAGE
VS
LOW-LEVEL OUTPUT CURRENT

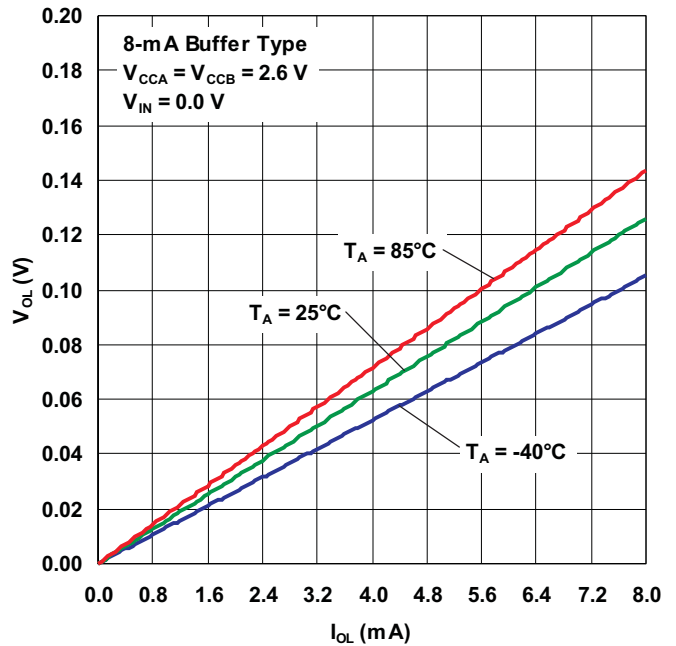

Figure 8.

TYPICAL CHARACTERISTICS (continued)

**HIGH-LEVEL OUTPUT VOLTAGE
vs
HIGH-LEVEL OUTPUT CURRENT**

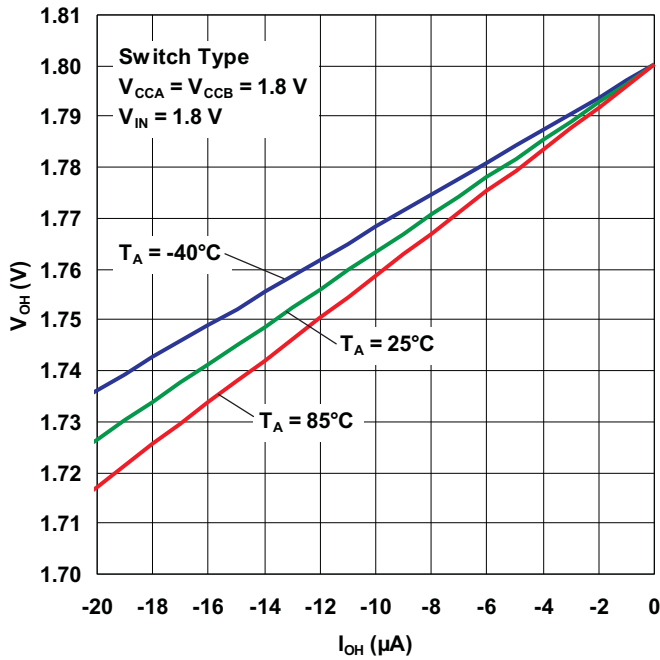

Figure 9.

**HIGH-LEVEL OUTPUT VOLTAGE
vs
HIGH-LEVEL OUTPUT CURRENT**

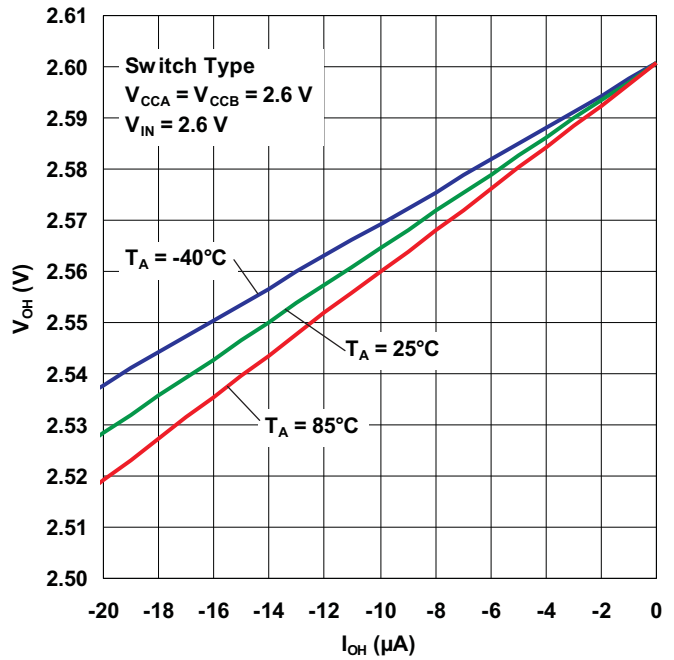

Figure 10.

**HIGH-LEVEL OUTPUT VOLTAGE
vs
HIGH-LEVEL OUTPUT CURRENT**

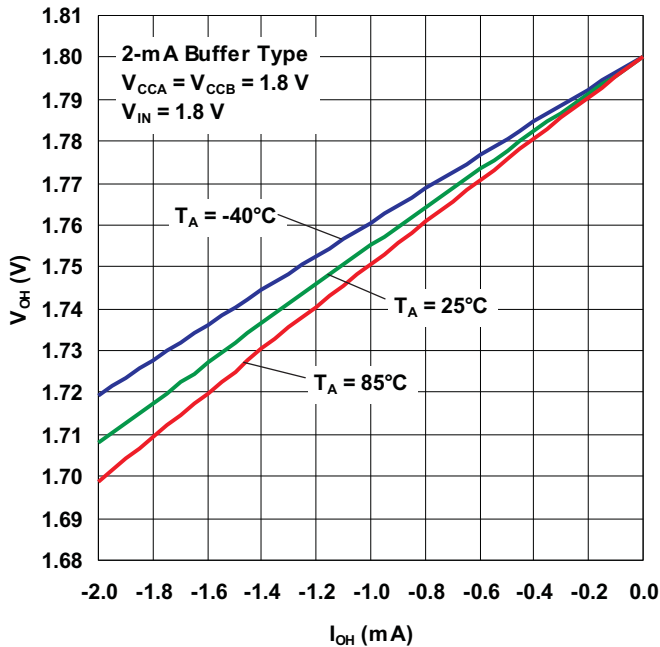

Figure 11.

**HIGH-LEVEL OUTPUT VOLTAGE
vs
HIGH-LEVEL OUTPUT CURRENT**

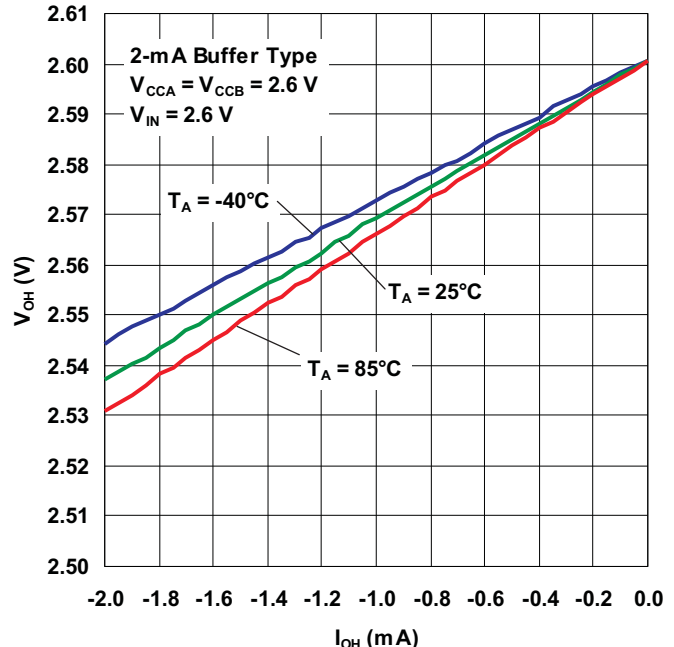

Figure 12.

TYPICAL CHARACTERISTICS (continued)

HIGH-LEVEL OUTPUT VOLTAGE
VS
HIGH-LEVEL OUTPUT CURRENT

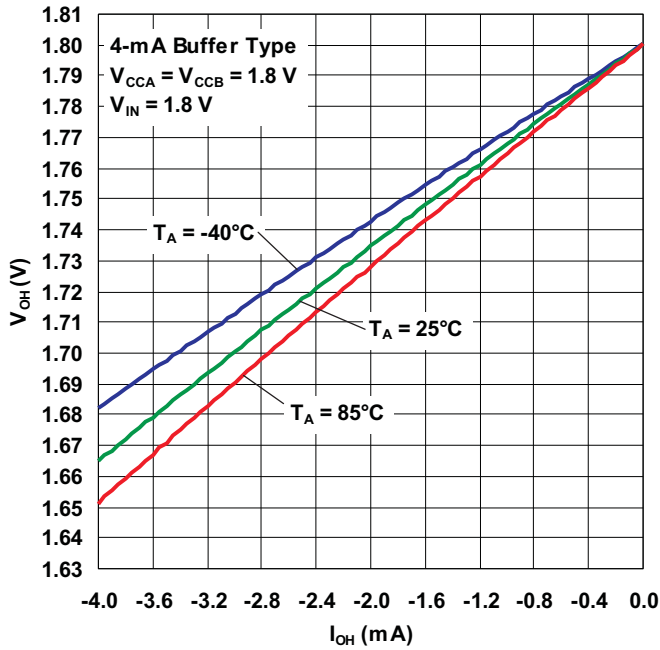

Figure 13.

HIGH-LEVEL OUTPUT VOLTAGE
VS
HIGH-LEVEL OUTPUT CURRENT

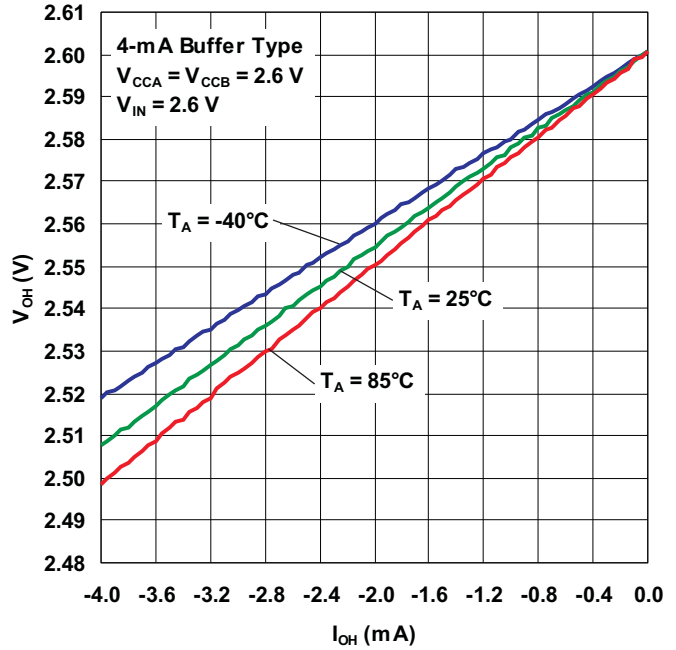

Figure 14.

HIGH-LEVEL OUTPUT VOLTAGE
VS
HIGH-LEVEL OUTPUT CURRENT

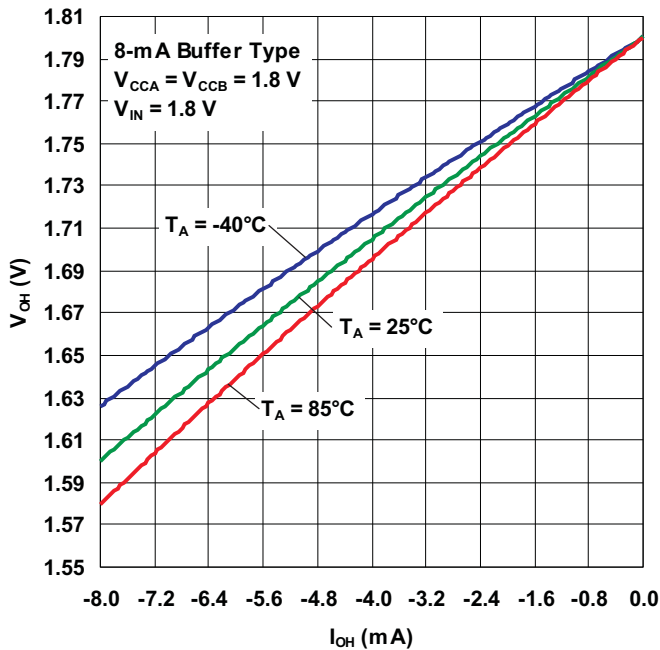

Figure 15.

HIGH-LEVEL OUTPUT VOLTAGE
VS
HIGH-LEVEL OUTPUT CURRENT

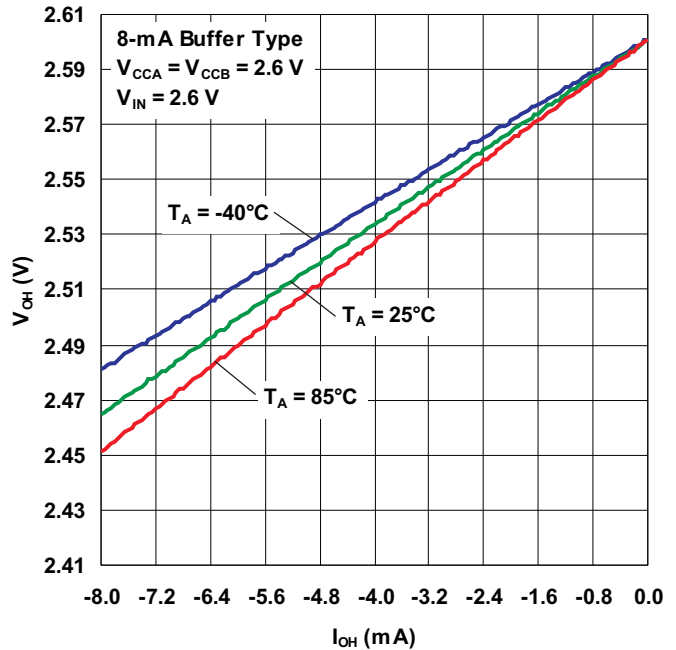

Figure 16.

TYPICAL CHARACTERISTICS (continued)

**PROPAGATION DELAY TIME (HIGH TO LOW)
VS
LOAD CAPACITANCE**

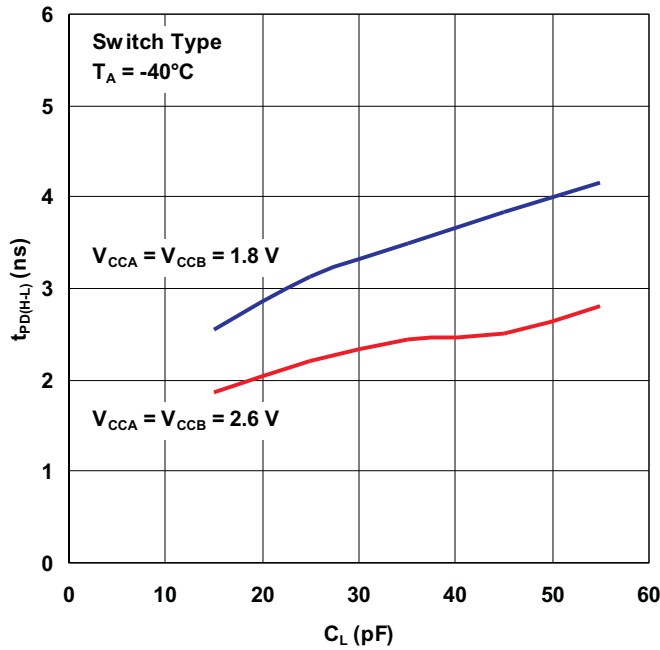

Figure 17.

**PROPAGATION DELAY TIME (LOW TO HIGH)
VS
LOAD CAPACITANCE**

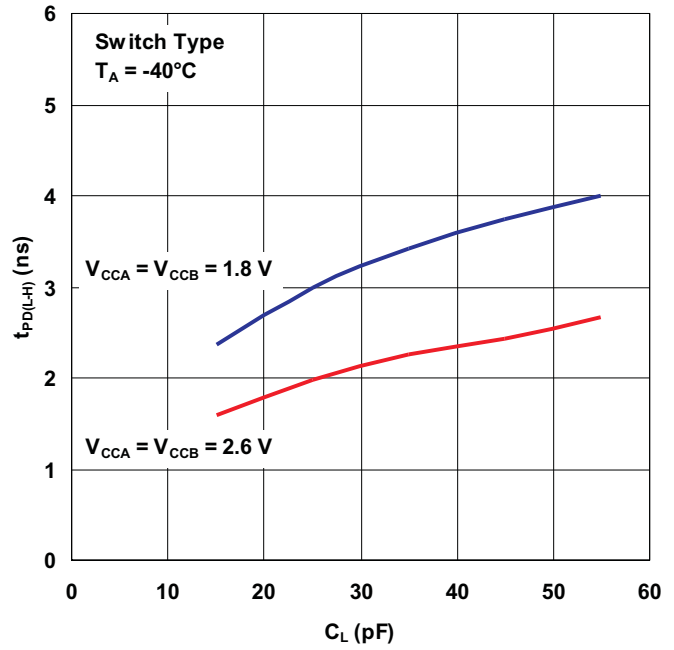

Figure 18.

**PROPAGATION DELAY TIME (HIGH TO LOW)
VS
LOAD CAPACITANCE**

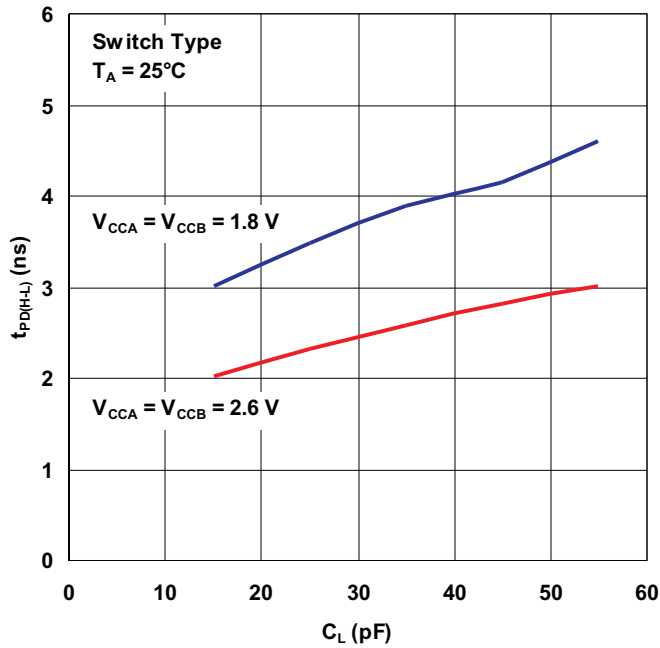

Figure 19.

**PROPAGATION DELAY TIME (LOW TO HIGH)
VS
LOAD CAPACITANCE**

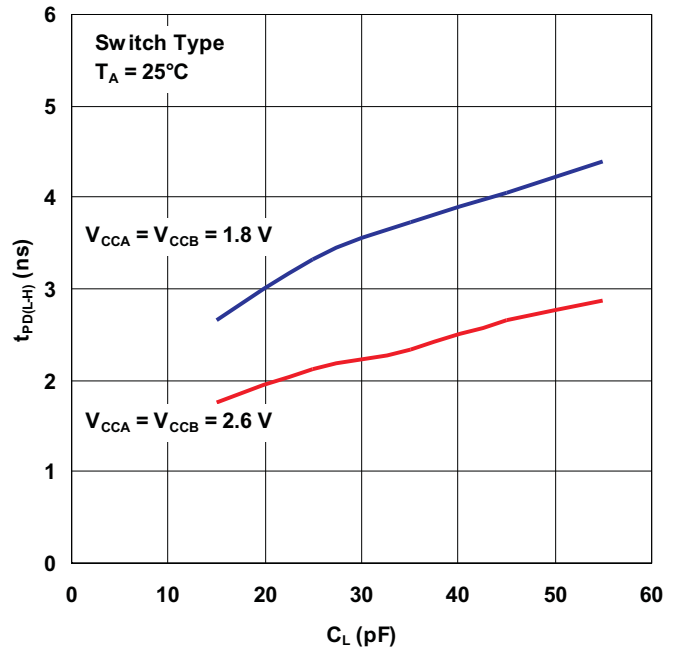

Figure 20.

TYPICAL CHARACTERISTICS (continued)

PROPAGATION DELAY TIME (HIGH TO LOW)
VS
LOAD CAPACITANCE

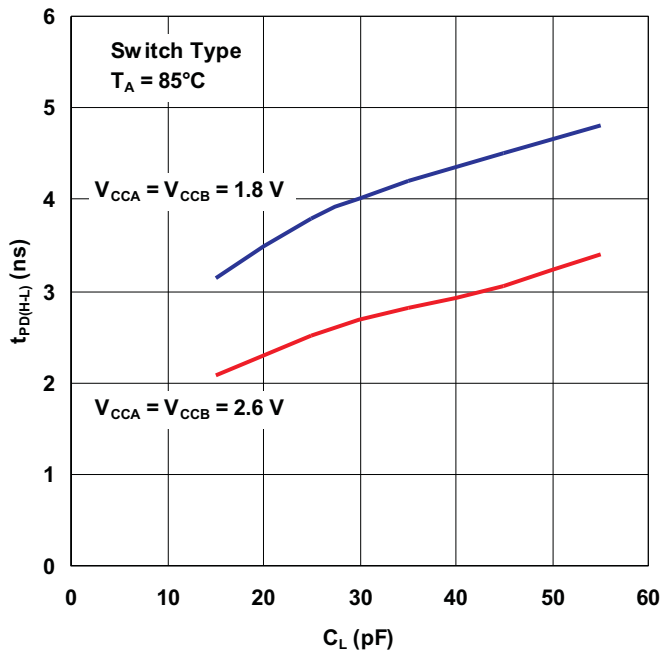

Figure 21.

PROPAGATION DELAY TIME (LOW TO HIGH)
VS
LOAD CAPACITANCE

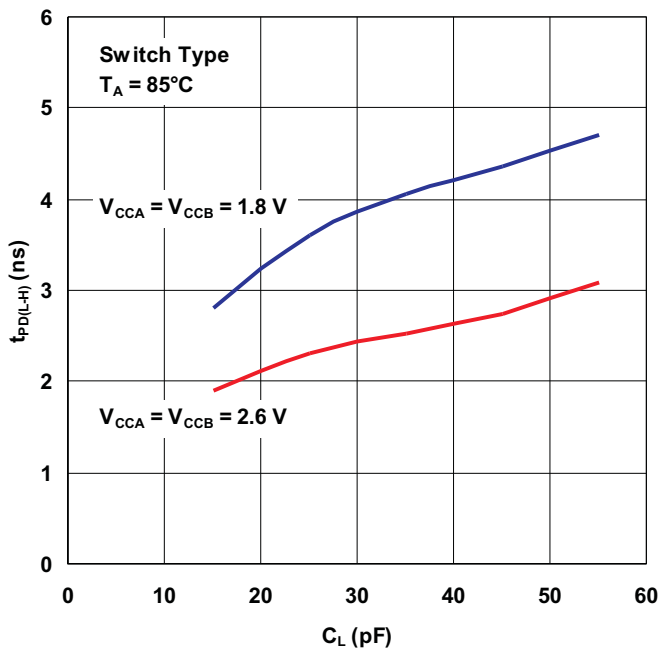

Figure 22.

Typical Application Wiring for TWL1200 When Connecting to the WL1271

Table 2. WL1271+TWL1200 Interface

| HOST (MSM) | PIN NAME | BALL NO. | TYPE | | TYPE | BALL NO. | PIN NAME | WL1271 COB |
|------------|-----------------|----------|---------------|---------|---------------|----------|----------------|------------|
| | VCCA | C4 | Power (3.0 V) | TWL1200 | Power (1.8 V) | C5 | VCCB | |
| | VCCA | D4 | Power (3.0 V) | | Power (1.8 V) | D5 | VCCB | |
| | SDIO_DATA0(A) | B2 | I/O ↔ | | I/O ↔ | B6 | SDIO_DATA0(B) | K4 |
| | SDIO_DATA1(A) | C2 | I/O ↔ | | I/O ↔ | C6 | SDIO_DATA1(B) | J4 |
| | SDIO_DATA2(A) | C1 | I/O ↔ | | I/O ↔ | C7 | SDIO_DATA2(B) | J3 |
| | SDIO_DATA3(A) | B1 | I/O ↔ | | I/O ↔ | B7 | SDIO_DATA3(B) | J5 |
| | SDIO_CMD(A) | A2 | I/O ↔ | | I/O ↔ | A6 | SDIO_CMD(B) | L3 |
| | SDIO_CLK(A) | A1 | I → | | O → | A7 | SDIO_CLK(B) | M3 |
| | WLAN_EN(A) | D1 | I → | | O → | D6 | WLAN_EN(B) | J2 |
| | WLAN_IRQ(A) | D2 | O ← | | I ← | D7 | WLAN_IRQ(B) | G4 |
| | CLK_REQ(A) | E1 | O ← | | I ← | E7 | CLK_REQ(B) | F5 |
| | BT_EN(A) | E2 | I → | | O → | E6 | BT_EN(B) | G5 |
| | BT_UART_RX(A) | G1 | I → | | O → | G7 | BT_UART_RX(B) | G7 |
| | BT_UART_CTS(A) | F1 | I → | | O → | F7 | BT_UART_CTS(B) | E11 |
| | BT_UART_TX(A) | G2 | O ← | | I ← | G6 | BT_UART_TX(B) | G8 |
| | BT_UART_RTS(A) | F2 | O ← | | I ← | F6 | BT_UART_RTS(B) | G11 |
| | AUDIO_IN(A) | F3 | I → | | I/O ↔ | F5 | AUDIO_IN(B) | F6 |
| | AUDIO_CLK(A) | A3 | I/O ↔ | | I/O ↔ | A5 | AUDIO_CLK(B) | F8 |
| | AUDIO_F-SYN(A) | B3 | I/O ↔ | | I/O ↔ | B5 | AUDIO_F-SYN(B) | H11 |
| | AUDIO_OUT(A) | G3 | O ← | | I ← | G5 | AUDIO_OUT(B) | F7 |
| | SLOW_CLK(A) | G4 | I → | | O → | F4 | SLOW_CLK(B) | K9 |
| | AUD_DIR | A4 | I → | | GND | D3 | GND | |
| | \overline{OE} | B4 | active low | | | E3 | GND | |
| | | | | | | E4 | GND | |
| | | | | | | E5 | GND | |

PARAMETER MEASUREMENT INFORMATION

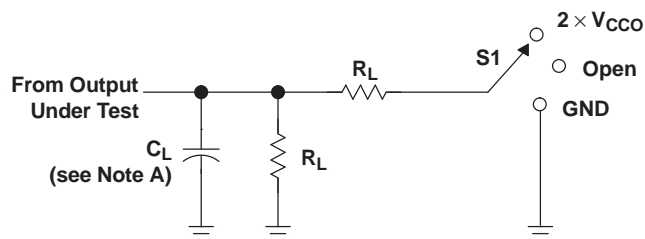

LOAD CIRCUIT FOR BUFFER-TYPE OUTPUTS

| V_{CCO} | C_L | R_L | V_{TP} |
|----------------------------------|-------|--------------|----------|
| $1.8\text{ V} \pm 0.15\text{ V}$ | 15 pF | 2 k Ω | 0.15 V |
| $2.5\text{ V} \pm 0.2\text{ V}$ | 15 pF | 2 k Ω | 0.15 V |
| $3.3\text{ V} \pm 0.3\text{ V}$ | 15 pF | 2 k Ω | 0.3 V |

| TEST | S1 |
|-------------------|--------------------|
| t_{pd} | Open |
| t_{PLZ}/t_{PZL} | $2 \times V_{CCO}$ |
| t_{PHZ}/t_{PZH} | GND |

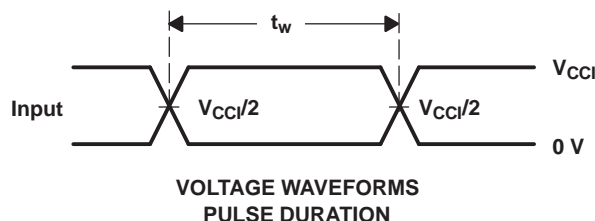

VOLTAGE WAVEFORMS PULSE DURATION

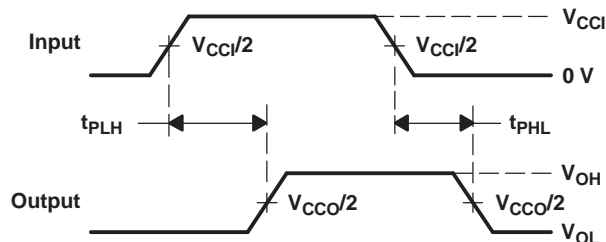

VOLTAGE WAVEFORMS PROPAGATION DELAY TIMES

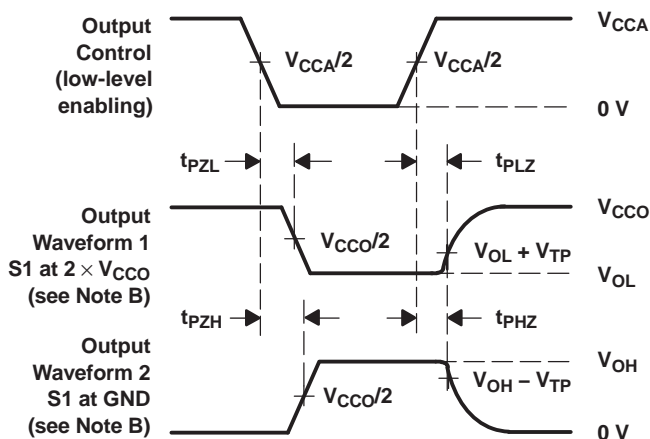

VOLTAGE WAVEFORMS ENABLE AND DISABLE TIMES

- NOTES:
- A. C_L includes probe and jig capacitance.
 - B. Waveform 1 is for an output with internal conditions such that the output is low, except when disabled by the output control. Waveform 2 is for an output with internal conditions such that the output is high, except when disabled by the output control.
 - C. All input pulses are supplied by generators having the following characteristics: $PRR \leq 10\text{ MHz}$, $Z_O = 50\ \Omega$, $dv/dt \geq 1\text{ V/ns}$.
 - D. The outputs are measured one at a time, with one transition per measurement.
 - E. t_{PLZ} and t_{PHZ} are the same as t_{dis} .
 - F. t_{PZL} and t_{PZH} are the same as t_{en} .
 - G. t_{PLH} and t_{PHL} are the same as t_{pd} .
 - H. V_{CC1} is the V_{CC} associated with the input port.
 - I. V_{CCO} is the V_{CC} associated with the output port.

Figure 23. Push-Pull Buffered Direction Control Load Circuit and Voltage Waveform

PARAMETER MEASUREMENT INFORMATION (continued)

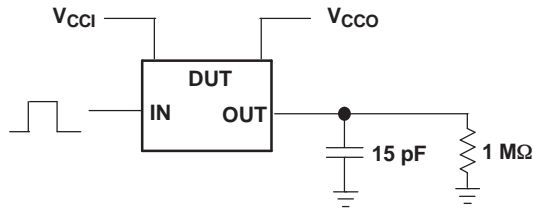

DATA RATE, PULSE DURATION, PROPAGATION DELAY, OUTPUT RISE AND FALL TIME MEASUREMENT USING A PUSH-PULL DRIVER

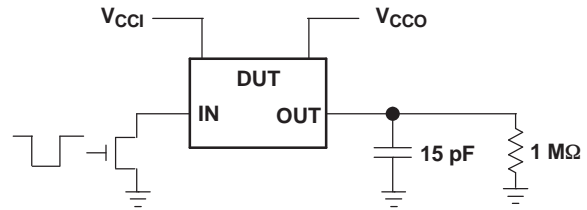

DATA RATE, PULSE DURATION, PROPAGATION DELAY, OUTPUT RISE AND FALL TIME MEASUREMENT USING AN OPEN-DRAIN DRIVER

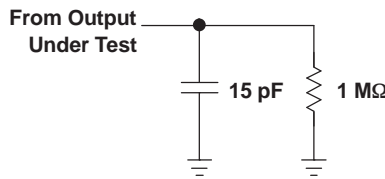

LOAD CIRCUIT FOR ENABLE/DISABLE TIME MEASUREMENT – SWITCH-TYPE SDIOS

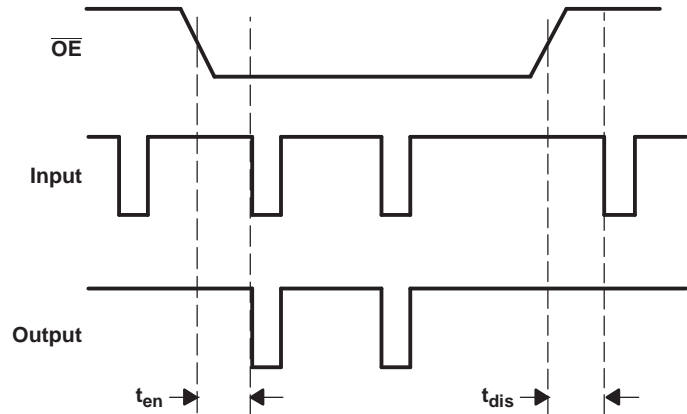
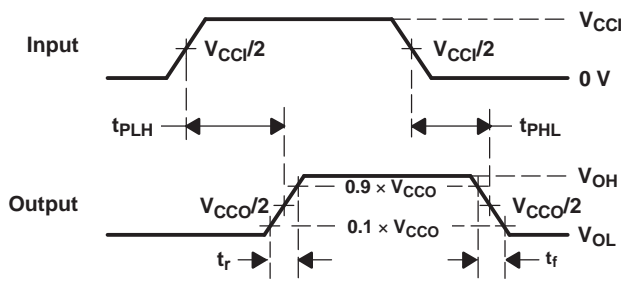
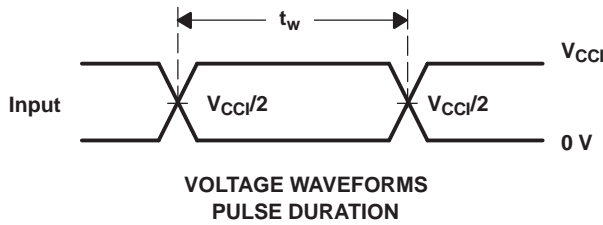

- A. C_L includes probe and jig capacitance.
- B. Waveform 1 is for an output with internal conditions such that the output is low, except when disabled by the output control. Waveform 2 is for an output with internal conditions such that the output is high, except when disabled by the output control.
- C. All input pulses are supplied by generators having the following characteristics: $PRR \leq 10$ MHz, $Z_O = 50 \Omega$, $dv/dt \geq 1$ V/ns.
- D. The outputs are measured one at a time, with one transition per measurement.
- E. t_{PLZ} and t_{PHZ} are the same as t_{dis} .
- F. t_{PZL} and t_{PZH} are the same as t_{en} .
- G. t_{PLH} and t_{PHL} are the same as t_{pd} .
- H. V_{CCI} is the V_{CC} associated with the input port.
- I. V_{CCO} is the V_{CC} associated with the output port.
- J. All parameters and waveforms are not applicable to all devices.

Figure 24. Auto-Direction Control Load Circuit and Voltage Waveform

APPLICATION CIRCUIT EXAMPLES

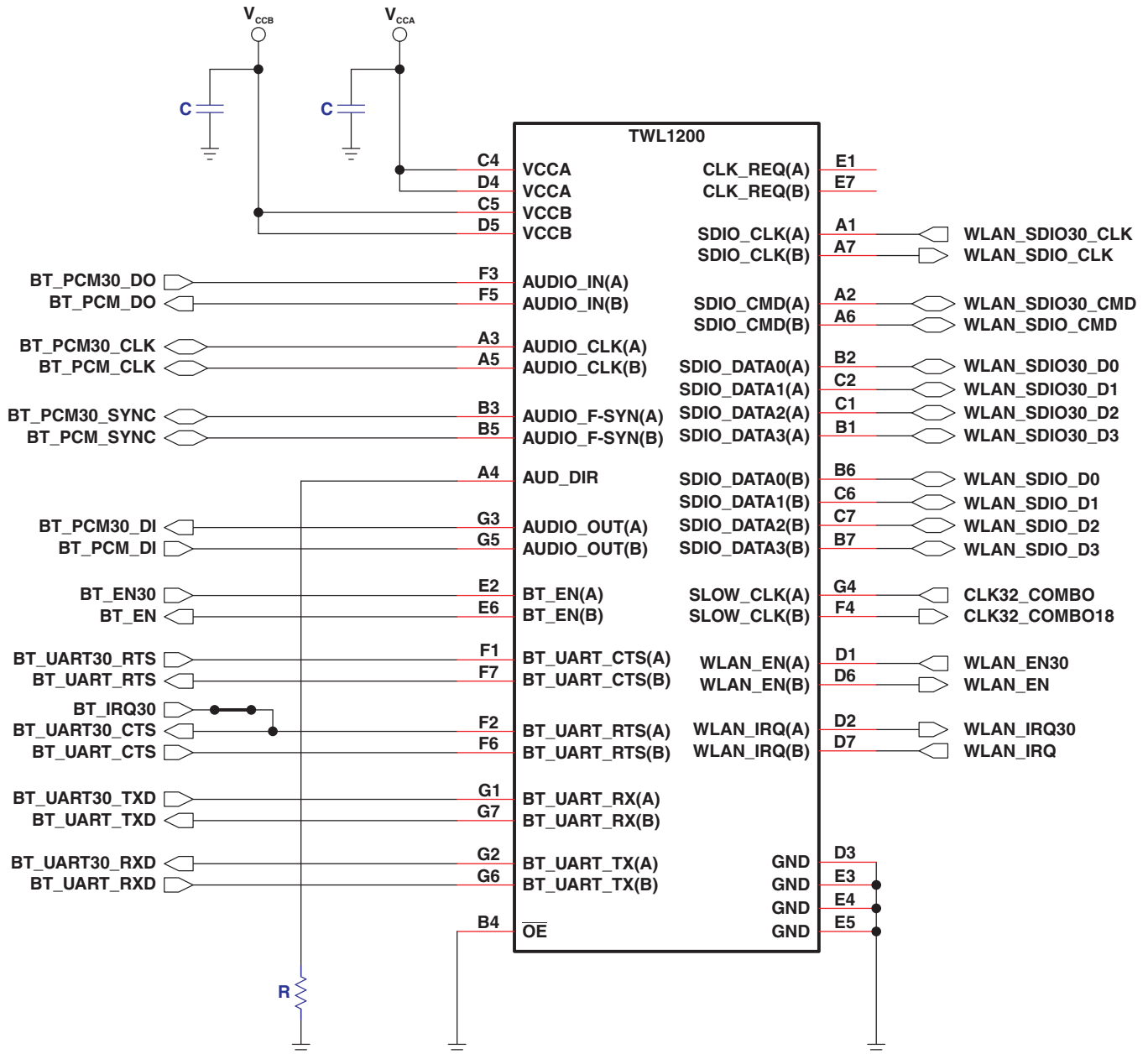

Figure 25. Application Circuit Example, OE Connection With Audio_CLK and Audio_F-SYNC Channels Established From B Side to A Side

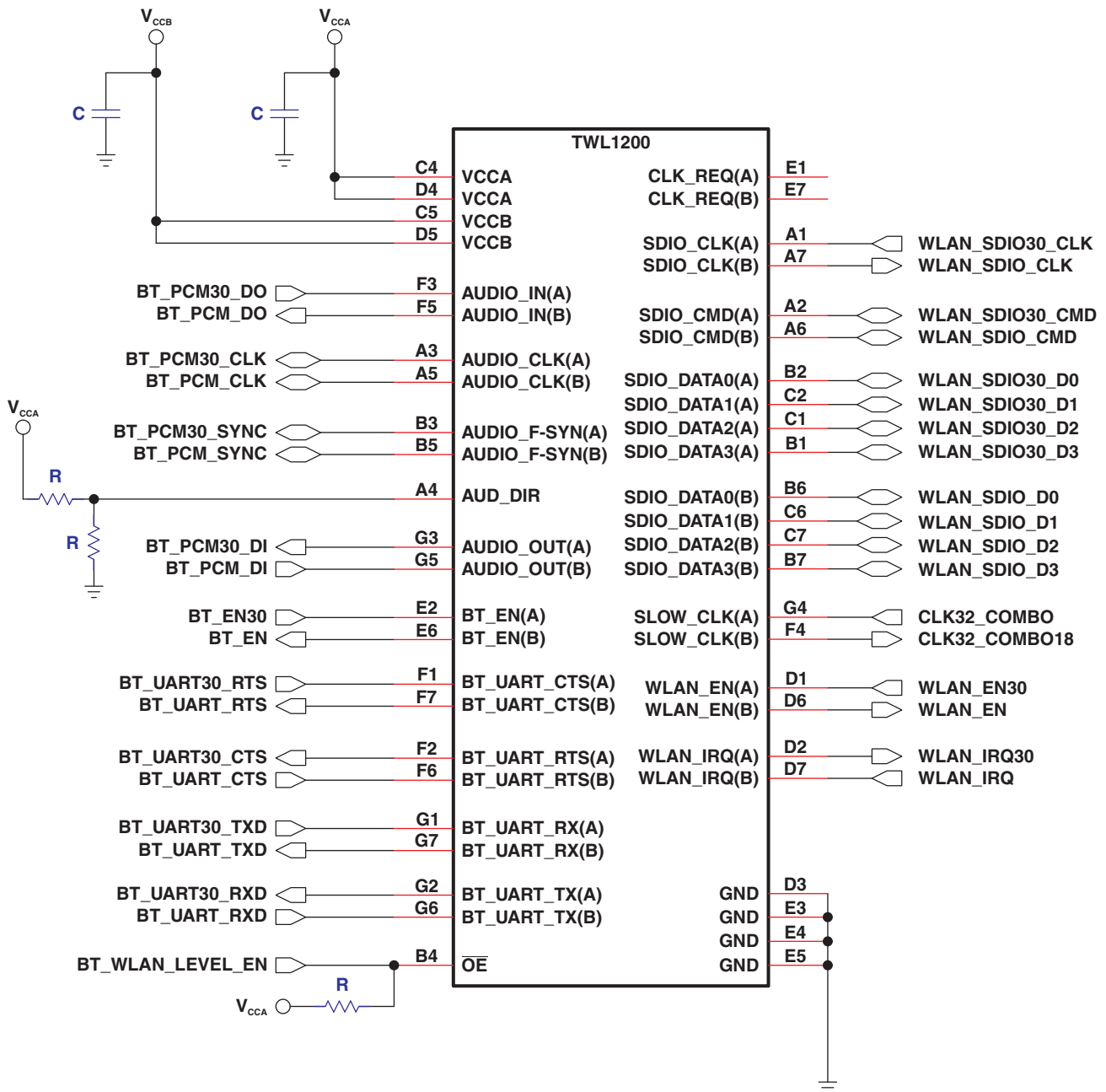

Figure 26. Application Circuit Example, With Voltage Divider for AUD_DIR Connection

PRINCIPLES OF OPERATION

Applications

The TWL1200 device has been designed to bridge the digital-switching compatibility gap between two voltage nodes to successfully interface logic threshold levels between a host processor and the Texas Instruments Wi-Link-6 WLAN/BT/FM products. It is intended to be used in a point-to-point topology when interfacing these devices that may or may not be operating at different interface voltages.

Architecture

The BT/UART and PCM/Audio subsystem interfaces consist of a fully-buffered voltage translator design that has its output transistors to source and sink current optimized for drive strength.

The SDIO lines comprise a semi-buffered auto-direction-sensing based translator architecture (see Figure 27) that does not require a direction-control signal to control the direction of data flow of the A to B ports (or from B to A ports).

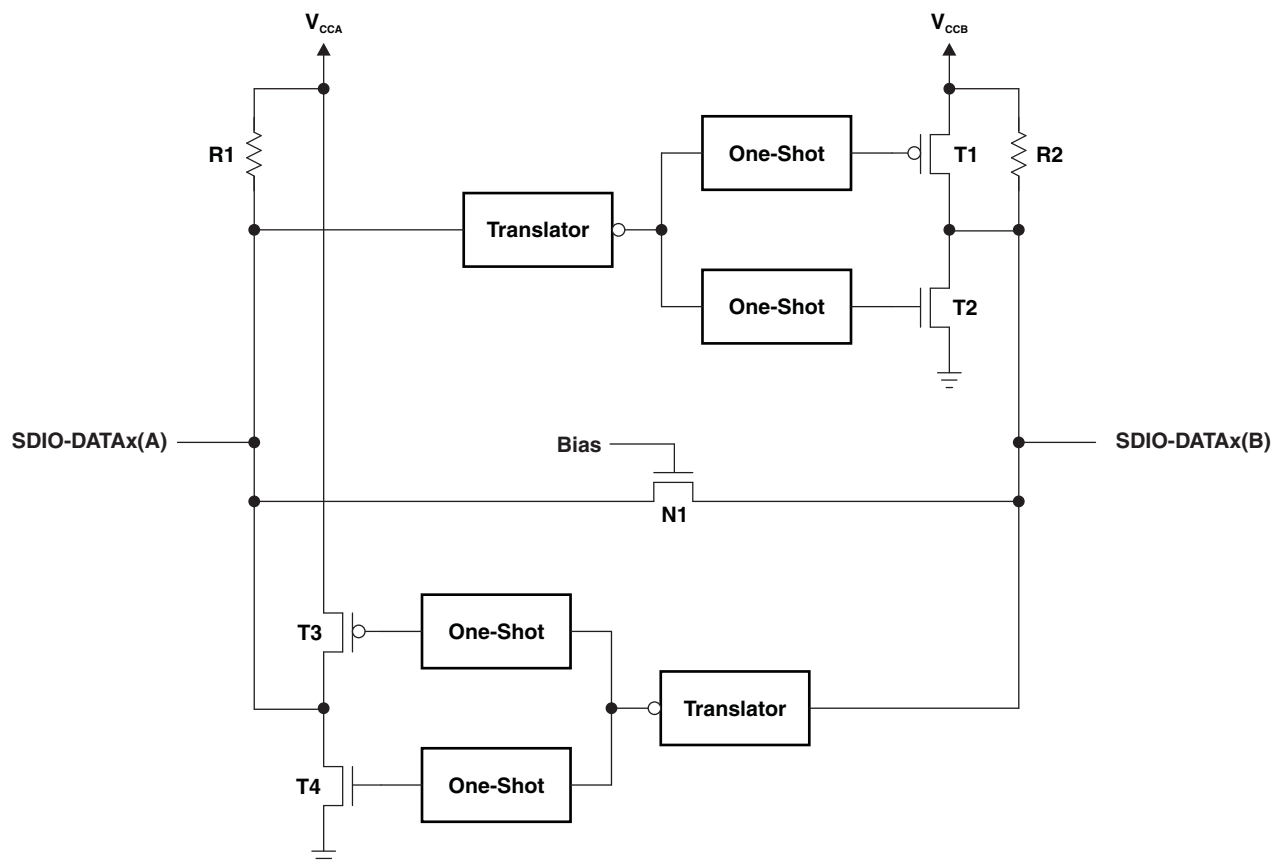

Figure 27. Architecture of an SDIO Switch-Type Cell

Each of these bidirectional SDIO channels independently determines the direction of data flow without a direction-control signal. Each I/O pin can be automatically reconfigured as either an input or an output, which is how this auto-direction feature is realized.

The following two key circuits are employed to facilitate the "switch-type" voltage translation function:

1. Integrated pullup resistors to provide dc-bias and drive capabilities
2. An N-channel pass-gate transistor topology (with a high R_{ON} of $\sim 300 \Omega$) that ties the A-port to the B-port
3. Output one-shot (O.S.) edge-rate accelerator circuitry to detect and accelerate rising edges on the A or B ports

For bidirectional voltage translation, pullup resistors are included on the device for dc current sourcing capability. The V_{GATE} gate bias of the N-channel pass transistor is set at a level that optimizes the switch characteristics for maximum data rate as well as minimal static supply leakage. Data can flow in either direction without guidance from a control signal.

The edge-rate acceleration circuitry speeds up the output slew rate by monitoring the input edge for transitions, helping maintain the data rate through the device.

During a low-to-high signal rising-edge, the O.S. circuits turn on the PMOS transistors (T_1, T_3) and its associated driver output resistance of the driver is decreased to approximately $50\ \Omega$ to $70\ \Omega$ during this acceleration phase to increase the current drive capability of the driver for approximately 30 ns or 95% of the input edge, whichever occurs first. This edge-rate acceleration provides high ac drive by bypassing the internal pullup resistors during the low-to-high transition to speed up the rising-edge signal.

During a high-to-low signal falling-edge, the O.S. circuits turn on the NMOS transistors (T_2, T_4) and its associated driver output resistance of the driver is decreased to approximately $50\ \Omega$ to $70\ \Omega$ during this acceleration phase to increase the current drive capability of the driver for approximately 30 ns or 95% of the input edge, whichever occurs first.

To minimize dynamic I_{CC} and the possibility of signal contention, the user should wait for the O.S. circuit to turn-off before applying a signal in the opposite direction. The worst-case duration is equal to the minimum pulse-width number provided in the *Timing Requirements* section of this data sheet.

Once the O.S. is triggered and switched off, both the A and B ports must go to the same state (i.e. both High or both Low) for the one-shot to trigger again. In a DC state, the output drivers maintain a Low state through the pass transistor. The output drivers maintain a High through the "smart pullup resistors" that dynamically change value based on whether a Low or a High is being passed through the SDIO lines, as follows:

- R_{PU1} and R_{PU2} values are $25\ k\Omega$ when the output is driving a low
- R_{PU1} and R_{PU2} values are $4\ k\Omega$ when the output is driving a high
- R_{PU1} and R_{PU2} values are $70\ k\Omega$ when the device is disabled via the \overline{OE} pin or by pulling the either V_{CCA} or V_{CCB} to 0 V.

The reason for using these "smart" pullup resistors is to allow the TWL1200 to realize a lower static power consumption (when the I/Os are low), support lower V_{OL} values for the same size pass-gate transistor, and improved simultaneous switching performance.

Input Driver Requirements

The continuous dc-current "sinking" capability is determined by the external system-level driver interfaced to the SDIO pins. Since the high bandwidth of these bidirectional SDIO circuits necessitates the need for a port to quickly change from an input to an output (and vice-versa), they have a modest dc-current "sourcing" capability of hundreds of micro-Amps, as determined by the smart pullup resistor values.

The fall time (t_{fA}, t_{fB}) of a signal depends on the edge rate and output impedance of the external device driving the SDIO I/Os, as well as the capacitive loading on these lines.

Similarly, the t_{pd} and max data rates also depend on the output impedance of the external driver. The values for t_{fA}, t_{fB}, t_{pd} , and maximum data rates in the data sheet assume that the output impedance of the external driver is less than $50\ \Omega$.

Output Load Considerations

TI recommends careful PCB layout practices with short PCB trace lengths to avoid excessive capacitive loading and to ensure that proper O.S. triggering takes place. PCB signal trace-lengths should be kept short enough such that the round trip delay of any reflection is less than the one-shot duration. This improves signal integrity by ensuring that any reflection sees a low impedance at the driver. The O.S. circuits have been designed to stay on for approximately 30 ns. The maximum capacitance of the lumped load that can be driven also depends directly on the one-shot duration. With very heavy capacitive loads, the one-shot can time-out before the signal is driven fully to the positive rail. The O.S. duration has been set to best optimize trade-offs between dynamic I_{CC} , load driving capability, and maximum bit-rate considerations. Both PCB trace length and connectors add to the capacitance that the TWL1200 SDIO output sees, so it is recommended that this lumped-load capacitance be considered and kept below $75\ pF$ to avoid O.S. retriggering, bus contention, output signal oscillations, or other adverse system-level affects.

Package Dimensions

The dimensions for the YFF package are shown in [Table 3](#). See the package drawing at the end of this data sheet.

Table 3. YFF Package Dimensions

| Packaged Device | D | E |
|-----------------|----------------|----------------|
| TWL1200YFFR | 2.76 ± 0.03 mm | 2.76 ± 0.03 mm |

PACKAGING INFORMATION

| Orderable Device | Status ⁽¹⁾ | Package Type | Package Drawing | Pins | Package Qty | Eco Plan ⁽²⁾ | Lead/ Ball Finish | MSL Peak Temp ⁽³⁾ | Samples (Requires Login) |
|------------------|-----------------------|----------------------------|-----------------|------|-------------|----------------------------|----------------------|------------------------------|-----------------------------|
| TWL1200YFFR | ACTIVE | DSBGA | YFF | 49 | 3000 | Green (RoHS & no Sb/Br) | SNAGCU | Level-1-260C-UNLIM | Add to cart |
| TWL1200ZQCR | ACTIVE | BGA MICROSTAR JUNIOR | ZQC | 48 | 2500 | Green (RoHS & no Sb/Br) | SNAGCU | Level-1-260C-UNLIM | Add to cart |

⁽¹⁾ The marketing status values are defined as follows:

ACTIVE: Product device recommended for new designs.

LIFEBUY: TI has announced that the device will be discontinued, and a lifetime-buy period is in effect.

NRND: Not recommended for new designs. Device is in production to support existing customers, but TI does not recommend using this part in a new design.

PREVIEW: Device has been announced but is not in production. Samples may or may not be available.

OBSOLETE: TI has discontinued the production of the device.

⁽²⁾ Eco Plan - The planned eco-friendly classification: Pb-Free (RoHS), Pb-Free (RoHS Exempt), or Green (RoHS & no Sb/Br) - please check <http://www.ti.com/productcontent> for the latest availability information and additional product content details.

TBD: The Pb-Free/Green conversion plan has not been defined.

Pb-Free (RoHS): TI's terms "Lead-Free" or "Pb-Free" mean semiconductor products that are compatible with the current RoHS requirements for all 6 substances, including the requirement that lead not exceed 0.1% by weight in homogeneous materials. Where designed to be soldered at high temperatures, TI Pb-Free products are suitable for use in specified lead-free processes.

Pb-Free (RoHS Exempt): This component has a RoHS exemption for either 1) lead-based flip-chip solder bumps used between the die and package, or 2) lead-based die adhesive used between the die and leadframe. The component is otherwise considered Pb-Free (RoHS compatible) as defined above.

Green (RoHS & no Sb/Br): TI defines "Green" to mean Pb-Free (RoHS compatible), and free of Bromine (Br) and Antimony (Sb) based flame retardants (Br or Sb do not exceed 0.1% by weight in homogeneous material)

⁽³⁾ MSL, Peak Temp. -- The Moisture Sensitivity Level rating according to the JEDEC industry standard classifications, and peak solder temperature.

Important Information and Disclaimer: The information provided on this page represents TI's knowledge and belief as of the date that it is provided. TI bases its knowledge and belief on information provided by third parties, and makes no representation or warranty as to the accuracy of such information. Efforts are underway to better integrate information from third parties. TI has taken and continues to take reasonable steps to provide representative and accurate information but may not have conducted destructive testing or chemical analysis on incoming materials and chemicals. TI and TI suppliers consider certain information to be proprietary, and thus CAS numbers and other limited information may not be available for release.

In no event shall TI's liability arising out of such information exceed the total purchase price of the TI part(s) at issue in this document sold by TI to Customer on an annual basis.

TAPE AND REEL INFORMATION

QUADRANT ASSIGNMENTS FOR PIN 1 ORIENTATION IN TAPE

*All dimensions are nominal

| Device | Package Type | Package Drawing | Pins | SPQ | Reel Diameter (mm) | Reel Width W1 (mm) | A0 (mm) | B0 (mm) | K0 (mm) | P1 (mm) | W (mm) | Pin1 Quadrant |
|-------------|----------------------|-----------------|------|------|--------------------|--------------------|---------|---------|---------|---------|--------|---------------|
| TWL1200YFFR | DSBGA | YFF | 49 | 3000 | 180.0 | 8.4 | 2.93 | 2.93 | 0.81 | 4.0 | 8.0 | Q1 |
| TWL1200ZQCR | BGA MICROSTAR JUNIOR | ZQC | 48 | 2500 | 330.0 | 12.4 | 4.3 | 4.3 | 1.5 | 8.0 | 12.0 | Q1 |

TAPE AND REEL BOX DIMENSIONS

*All dimensions are nominal

| Device | Package Type | Package Drawing | Pins | SPQ | Length (mm) | Width (mm) | Height (mm) |
|-------------|----------------------|-----------------|------|------|-------------|------------|-------------|
| TWL1200YFFR | DSBGA | YFF | 49 | 3000 | 210.0 | 185.0 | 35.0 |
| TWL1200ZQCR | BGA MICROSTAR JUNIOR | ZQC | 48 | 2500 | 340.5 | 338.1 | 20.6 |

ZQC (S-PBGA-N48)

PLASTIC BALL GRID ARRAY

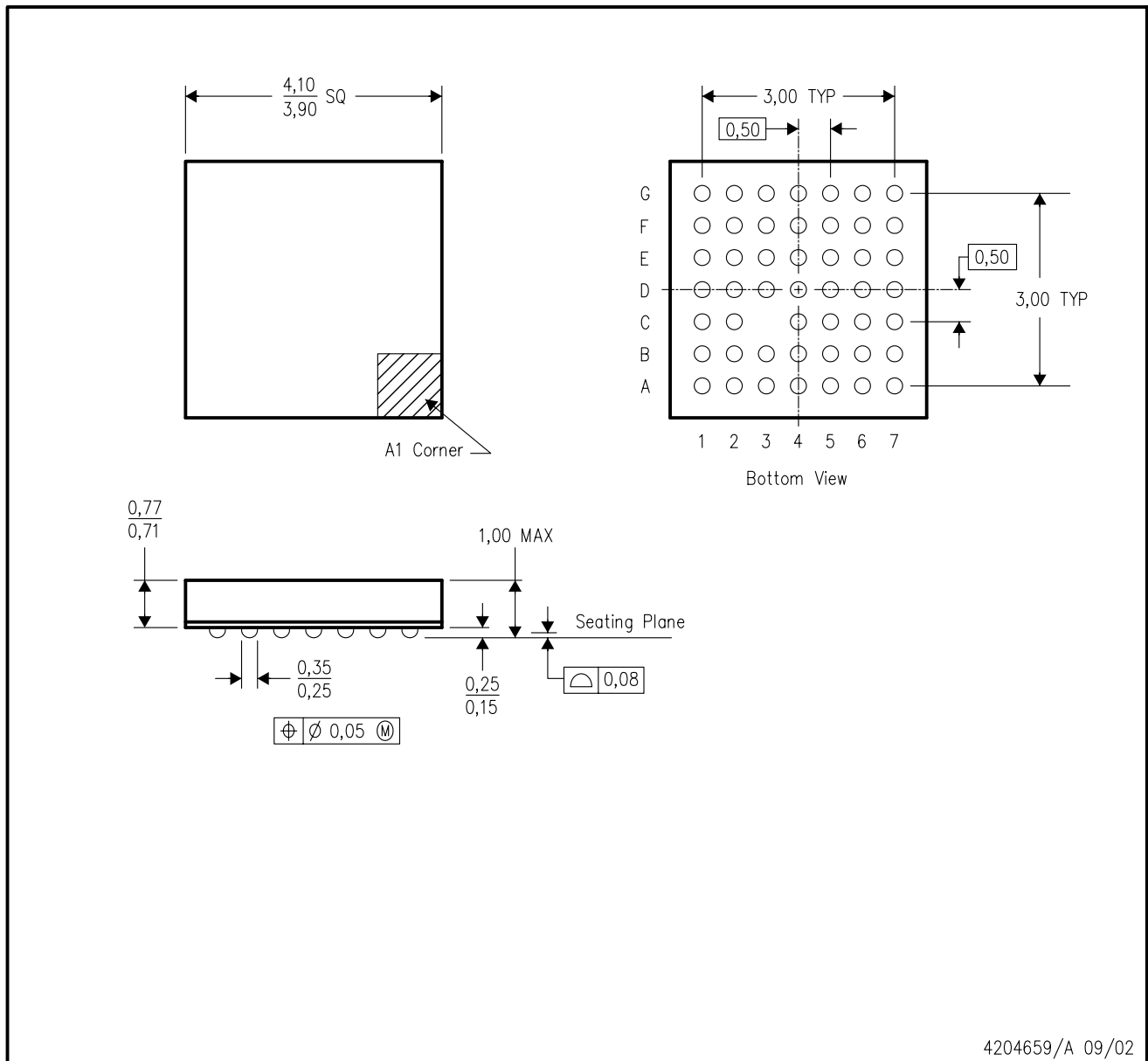

- NOTES:
- A. All linear dimensions are in millimeters.
 - B. This drawing is subject to change without notice.
 - C. MicroStar Junior™ BGA configuration
 - D. Falls within JEDEC MO-225
 - E. This package is lead-free.

MicroStar Junior is a trademark of Texas Instruments.

YFF (R-XBGA-N49)

DIE-SIZE BALL GRID ARRAY

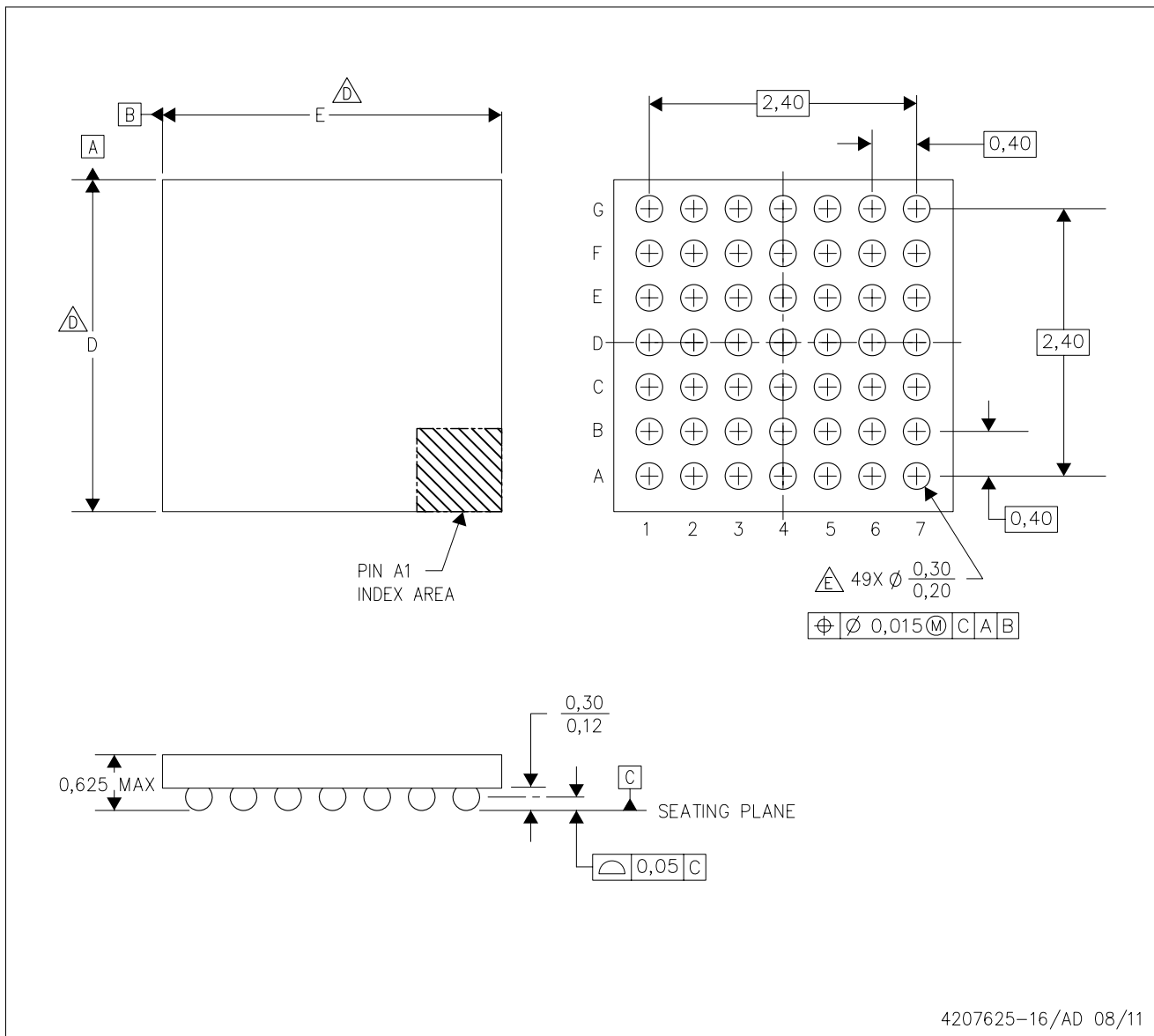

- NOTES:
- A. All linear dimensions are in millimeters. Dimensioning and tolerancing per ASME Y14.5M-1994.
 - B. This drawing is subject to change without notice.
 - C. NanoFree™ package configuration.
 - △ The package size (Dimension D and E) of a particular device is specified in the device Product Data Sheet version of this drawing, in case it cannot be found in the product data sheet please contact a local TI representative.
 - E. Reference Product Data Sheet for array population.
7 x 7 matrix pattern is shown for illustration only.
 - F. This package contains Pb-free balls.

IMPORTANT NOTICE

Texas Instruments Incorporated and its subsidiaries (TI) reserve the right to make corrections, modifications, enhancements, improvements, and other changes to its products and services at any time and to discontinue any product or service without notice. Customers should obtain the latest relevant information before placing orders and should verify that such information is current and complete. All products are sold subject to TI's terms and conditions of sale supplied at the time of order acknowledgment.

TI warrants performance of its hardware products to the specifications applicable at the time of sale in accordance with TI's standard warranty. Testing and other quality control techniques are used to the extent TI deems necessary to support this warranty. Except where mandated by government requirements, testing of all parameters of each product is not necessarily performed.

TI assumes no liability for applications assistance or customer product design. Customers are responsible for their products and applications using TI components. To minimize the risks associated with customer products and applications, customers should provide adequate design and operating safeguards.

TI does not warrant or represent that any license, either express or implied, is granted under any TI patent right, copyright, mask work right, or other TI intellectual property right relating to any combination, machine, or process in which TI products or services are used. Information published by TI regarding third-party products or services does not constitute a license from TI to use such products or services or a warranty or endorsement thereof. Use of such information may require a license from a third party under the patents or other intellectual property of the third party, or a license from TI under the patents or other intellectual property of TI.

Reproduction of TI information in TI data books or data sheets is permissible only if reproduction is without alteration and is accompanied by all associated warranties, conditions, limitations, and notices. Reproduction of this information with alteration is an unfair and deceptive business practice. TI is not responsible or liable for such altered documentation. Information of third parties may be subject to additional restrictions.

Resale of TI products or services with statements different from or beyond the parameters stated by TI for that product or service voids all express and any implied warranties for the associated TI product or service and is an unfair and deceptive business practice. TI is not responsible or liable for any such statements.

TI products are not authorized for use in safety-critical applications (such as life support) where a failure of the TI product would reasonably be expected to cause severe personal injury or death, unless officers of the parties have executed an agreement specifically governing such use. Buyers represent that they have all necessary expertise in the safety and regulatory ramifications of their applications, and acknowledge and agree that they are solely responsible for all legal, regulatory and safety-related requirements concerning their products and any use of TI products in such safety-critical applications, notwithstanding any applications-related information or support that may be provided by TI. Further, Buyers must fully indemnify TI and its representatives against any damages arising out of the use of TI products in such safety-critical applications.

TI products are neither designed nor intended for use in military/aerospace applications or environments unless the TI products are specifically designated by TI as military-grade or "enhanced plastic." Only products designated by TI as military-grade meet military specifications. Buyers acknowledge and agree that any such use of TI products which TI has not designated as military-grade is solely at the Buyer's risk, and that they are solely responsible for compliance with all legal and regulatory requirements in connection with such use.

TI products are neither designed nor intended for use in automotive applications or environments unless the specific TI products are designated by TI as compliant with ISO/TS 16949 requirements. Buyers acknowledge and agree that, if they use any non-designated products in automotive applications, TI will not be responsible for any failure to meet such requirements.

Following are URLs where you can obtain information on other Texas Instruments products and application solutions:

Products

| | |
|------------------------|--|
| Audio | www.ti.com/audio |
| Amplifiers | amplifier.ti.com |
| Data Converters | dataconverter.ti.com |
| DLP® Products | www.dlp.com |
| DSP | dsp.ti.com |
| Clocks and Timers | www.ti.com/clocks |
| Interface | interface.ti.com |
| Logic | logic.ti.com |
| Power Mgmt | power.ti.com |
| Microcontrollers | microcontroller.ti.com |
| RFID | www.ti-rfid.com |
| OMAP Mobile Processors | www.ti.com/omap |
| Wireless Connectivity | www.ti.com/wirelessconnectivity |

Applications

| | |
|-------------------------------|--|
| Communications and Telecom | www.ti.com/communications |
| Computers and Peripherals | www.ti.com/computers |
| Consumer Electronics | www.ti.com/consumer-apps |
| Energy and Lighting | www.ti.com/energy |
| Industrial | www.ti.com/industrial |
| Medical | www.ti.com/medical |
| Security | www.ti.com/security |
| Space, Avionics and Defense | www.ti.com/space-avionics-defense |
| Transportation and Automotive | www.ti.com/automotive |
| Video and Imaging | www.ti.com/video |

TI E2E Community Home Page

e2e.ti.com

Mailing Address: Texas Instruments, Post Office Box 655303, Dallas, Texas 75265
Copyright © 2011, Texas Instruments Incorporated