

FEATURES

- **OPERATIONAL AMPLIFIER**
 - Low Offset Voltage, Max of:
 - TSM104WA...3 mV (25°C) and 4 mV (Full Temperature)
 - TSM104W...5 mV (25°C) and 6 mV (Full Temperature)
 - Low Supply Current...375 μ A/Channel Typ at $V_{CC} = 5$ V
 - Unity Gain Bandwidth...0.9 MHz Typ
 - Input Common-Mode Range Includes GND
 - Large Output-Voltage Swing...0 V to $V_{CC} - 2$ V
 - Wide Supply-Voltage Range...3 V to 30 V
 - 2-kV ESD Protection (HBM)
- **VOLTAGE REFERENCE**
 - Adjustable Output Voltage... V_{REF} to 36 V
 - $V_{REF} = 2.5$ V With Tight Tolerance, Max of:
 - TSM104WA...0.4% (25°C) and 0.8% (Full Temperature)
 - TSM104W...1% (25°C) and 2% (Full Temperature)
 - Low Temperature Drift...7 mV Typ Over Operating Temperature Range
 - Wide Sink-Current Range...0.5 mA Typ to 100 mA
 - Output Impedance...0.2 Ω Typ

TYPICAL APPLICATIONS

- Battery Chargers
- Switch-Mode Power Supplies
- Linear Voltage Regulation
- Data-Acquisition Systems

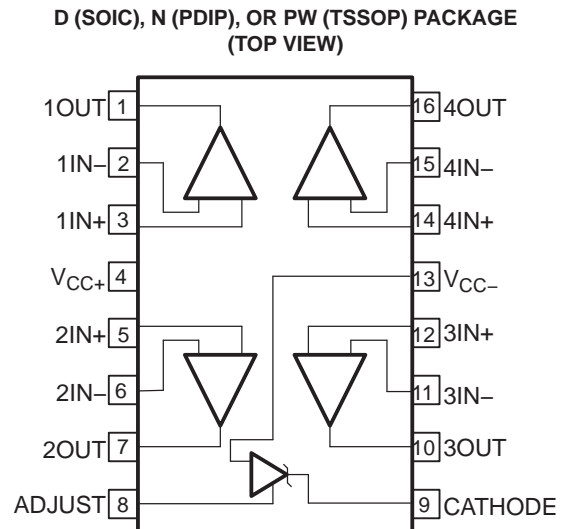

DESCRIPTION/ORDERING INFORMATION

The TSM104W combines the building blocks of a quad operational amplifier and an adjustable voltage reference, both of which often are used in the control circuitry of switch-mode power supplies.

For the A grade, especially tight voltage regulation can be achieved through the low offset voltage for each operational amplifier (typically 0.5 mV) and tight tolerance for the voltage reference (0.4% at 25°C and 0.8% over operating temperature range).

The TSM104W and TSM104WA are characterized for operation from -40°C to 105°C .



Please be aware that an important notice concerning availability, standard warranty, and use in critical applications of Texas Instruments semiconductor products and disclaimers thereto appears at the end of this data sheet.

TSM104W, TSM104WA QUAD OPERATIONAL AMPLIFIER AND PROGRAMMABLE VOLTAGE REFERENCE

SLOS478D–JULY 2005–REVISED AUGUST 2006

ORDERING INFORMATION

T _A	MAX V _{IO} AND V _{REF} TOLERANCE (25°C)	PACKAGE ⁽¹⁾		ORDERABLE PART NUMBER	TOP-SIDE MARKING
–40°C to 105°C	A grade 3 mV, 0.4%	PDIP – N	Tube of 25	TSM104WAIN	PREVIEW
		SOIC – D	Tube of 75	TSM104WAID	TSM104WAI
			Reel of 2500	TSM104WAIDR	
		TSSOP – PW	Tube of 75	TSM104WAIPW	SM104AI
			Reel of 2000	TSM104WAIPWR	
		Standard grade 5 mV, 1%	PDIP – N	Tube of 25	TSM104WIN
	SOIC – D		Tube of 75	TSM104WID	TSM104WI
			Reel of 2500	TSM104WIDR	
	TSSOP – PW		Tube of 75	TSM104WIPW	SM104I
			Reel of 2000	TSM104WIPWR	

(1) Package drawings, standard packing quantities, thermal data, symbolization, and PCB design guidelines are available at www.ti.com/sc/package.

Absolute Maximum Ratings⁽¹⁾

over free-air temperature range (unless otherwise noted)

		MIN	MAX	UNIT
V _{CC}	Supply voltage		36	V
V _{ID}	Operational amplifier input differential voltage		36	V
V _I	Operational amplifier input voltage range	–0.3	36	V
I _{KA}	Voltage reference cathode current		100	mA
θ _{JA}	Package thermal impedance ⁽²⁾⁽³⁾	D package		73
		N package		67
		PW package		108
T _J	Maximum junction temperature		150	°C
T _{stg}	Storage temperature range	–65	150	°C

- (1) Stresses beyond those listed under “absolute maximum ratings” may cause permanent damage to the device. These are stress ratings only, and functional operation of the device at these or any other conditions beyond those indicated under “recommended operating conditions” is not implied. Exposure to absolute-maximum-rated conditions for extended periods may affect device reliability.
- (2) Maximum power dissipation is a function of T_{J(max)}, θ_{JA}, and T_A. The maximum allowable power dissipation at any allowable ambient temperature is P_D = (T_{J(max)} – T_A)/θ_{JA}. Selecting the maximum of 150°C can affect reliability.
- (3) The package thermal impedance is calculated in accordance with JESD 51-7.

Recommended Operating Conditions

		MIN	MAX	UNIT
V _{CC+} – V _{CC-}	Supply voltage	3	30	V
I _K	Cathode current	1	100	mA
T _A	Operating free-air temperature	–40	105	°C

Total Device Electrical Characteristics

PARAMETER		TEST CONDITIONS	T _A	MIN	TYP	MAX	UNIT
I _{CC}	Total supply current, excluding cathode-current reference	V _{CC+} = 5 V, No load	Full range		1.4	2.4	mA
		V _{CC+} = 30 V, No load					

Operational Amplifier Electrical Characteristics

 V_{CC+} = 5 V, V_{CC-} = GND, V_O = 1.4 V, T_A = 25°C (unless otherwise noted)

PARAMETER		TEST CONDITIONS	T _A	MIN	TYP	MAX	UNIT
V _{IO}	Input offset voltage	TSM104W	25°C		1	5	mV
			Full range			6	
		TSM104WA	25°C		0.5	3	
			Full range			4	
αV _{IO}	Input offset voltage drift		25°C		7		μV/°C
I _{IO}	Input offset current		25°C		2	30	nA
			Full range			50	
I _{IB}	Input bias current		25°C		30	150	nA
			Full range			200	
A _{VD}	Large-signal voltage gain	V _{CC+} = 15 V, R _L = 2 kΩ, V _O = 1.4 V to 11.4 V	25°C	50	100		V/mV
			Full range		25		
k _{SVR}	Supply-voltage rejection ratio	V _{CC+} = 5 V to 30 V	25°C	65	100		dB
V _{ICR}	Input common-mode voltage range	V _{CC+} = 30 V ⁽¹⁾	25°C	0		V _{CC+} – 1.5	V
			Full range		0		
CMRR	Common-mode rejection ratio		25°C	70	85		dB
			Full range		60		
I _{source}	Output source current	V _{CC+} = 15 V, V _O = 2 V, V _{id} = 1 V	25°C	20	40		mA
I _{SC}	Short circuit to GND	V _{CC+} = 15 V	25°C		40	60	mA
I _{sink}	Output sink current	V _{CC+} = 15 V, V _O = 2 V, V _{id} = –1 V	25°C	10	20		mA
V _{OH}	High-level output voltage	V _{CC+} = 30 V, R _L = 10 kΩ	25°C	27	28		V
			Full range		27		
V _{OL}	Low-level output voltage	R _L = 10 kΩ	25°C		5	20	mV
			Full range			20	
SR	Slew rate at unity gain	V _{CC+} = 15 V, C _L = 100 pF, R _L = 2 kΩ, V _I = 0.5 V to 3 V, unity gain	25°C	0.1	0.3		V/μs
GBW	Gain bandwidth product	V _{CC+} = 30 V, V _I = 10 mV, C _L = 100 pF, R _L = 2 kΩ, f = 100 kHz	25°C	0.5	0.9		MHz
THD	Total harmonic distortion	V _{CC+} = 30 V, V _O = 2 V _{pp} , C _L = 100 pF, R _L = 2 kΩ, f = 1 kHz, A _V = 20 dB	25°C		0.01		%
V _n	Equivalent input noise voltage	V _{CC} = 30 V, R _S = 100 Ω, f = 1 kHz	25°C		25		nV/√Hz
	Channel separation	1 kHz < f < 20 kHz	25°C		120		dB

(1) The input common-mode voltage of either input should not be allowed to go below –0.3 V. The upper end of the common-mode voltage range is V_{CC+} – 1.5 V, but either input can go to V_{CC+} + 0.3 V without damage (absolute maximum ratings still must be observed).

TSM104W, TSM104WA QUAD OPERATIONAL AMPLIFIER AND PROGRAMMABLE VOLTAGE REFERENCE

SLOS478D–JULY 2005–REVISED AUGUST 2006

Voltage Reference Electrical Characteristics

PARAMETER		TEST CONDITIONS	T _A	MIN	TYP	MAX	UNIT	
V _{REF}	Reference voltage	TSM104W	I _K = 10 mA	25°C	2.475	2.5	2.525	V
				Full range	2.45		2.55	
		TSM104WA	I _K = 10 mA	25°C	2.49	2.5	2.51	
				Full range	2.48		2.52	
ΔV _{REF}	Reference input voltage deviation over temperature range	V _{KA} = V _{REF} , I _K = 10 mA	Full range		7	30	mV	
$\frac{\Delta V_{REF}}{\Delta V_{KA}}$	Ratio of change in reference voltage to change in cathode voltage	V _{KA} = 3 V to 36 V, I _K = 10 mA	25°C	–2	–1.1		mV/V	
I _{REF}	Reference input current	I _K = 10 mA	25°C		1.5	2.5	μA	
			Full range			3		
ΔI _{REF}	Reference input current deviation over temperature range		Full range		0.8	1.2	μA	
I _{min}	Minimum cathode current for regulation	V _{KA} = V _{REF}	25°C		0.5	1	mA	
I _{K,OFF}	Off-state cathode current		25°C		180	500	nA	
z _{ka}	Dynamic impedance ⁽¹⁾	V _{KA} = V _{REF} , f < 1 kHz, ΔI _K = 1 mA to 100 mA	25°C		0.2	0.5	Ω	

(1) The dynamic impedance is defined as $|z_{ka}| = \frac{\Delta V_{KA}}{\Delta I_K}$.

TYPICAL OPERATING CHARACTERISTICS

$T_A = 25^\circ\text{C}$ (unless otherwise noted)

**TOTAL HARMONIC DISTORTION (THD)
vs
FREQUENCY**

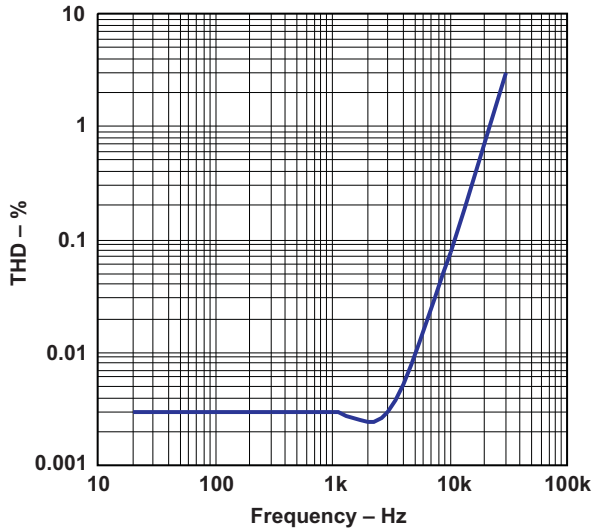

Figure 1.

**AMPLIFIER NOISE VOLTAGE
vs
FREQUENCY**

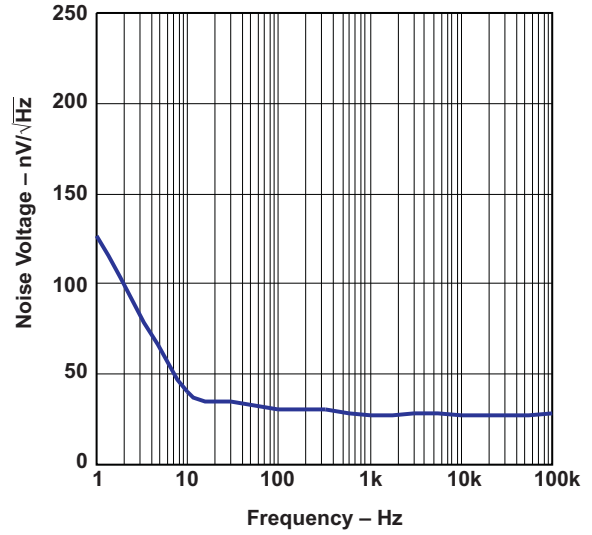

Figure 2.

**I_K
vs
 V_{REF}**

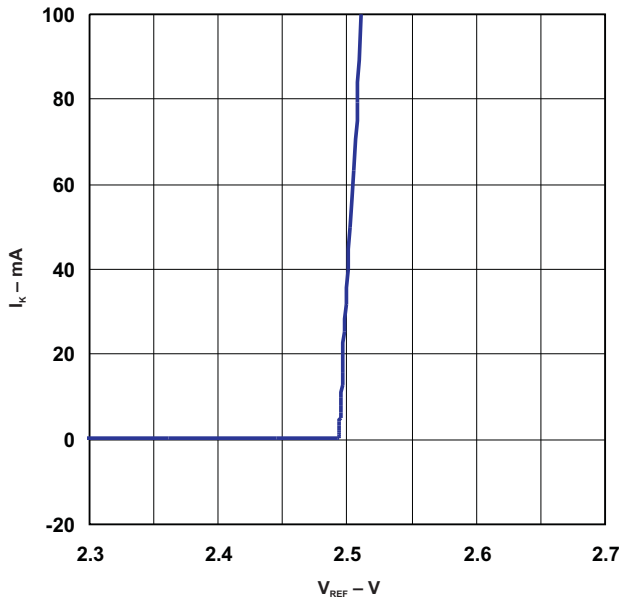

Figure 3.

**V_{REF} STABILITY
vs
CAPACITANCE**

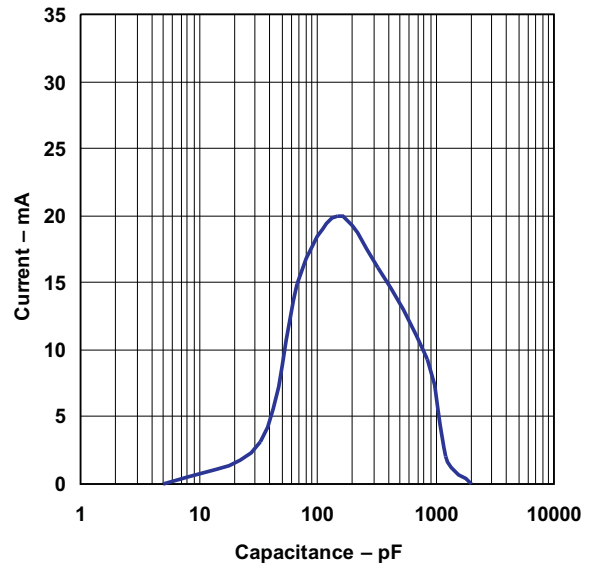

Figure 4.

TSM104W, TSM104WA QUAD OPERATIONAL AMPLIFIER AND PROGRAMMABLE VOLTAGE REFERENCE

SLOS478D–JULY 2005–REVISED AUGUST 2006

TYPICAL OPERATING CHARACTERISTICS (continued)

$T_A = 25^\circ\text{C}$ (unless otherwise noted)

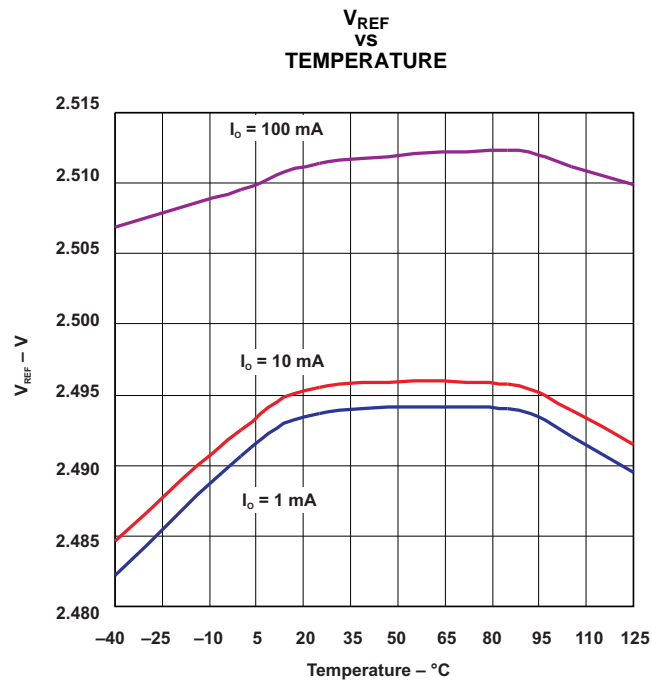

Figure 5.

PACKAGING INFORMATION

Orderable Device	Status ⁽¹⁾	Package Type	Package Drawing	Pins	Package Qty	Eco Plan ⁽²⁾	Lead/Ball Finish	MSL Peak Temp ⁽³⁾
TSM104WAID	ACTIVE	SOIC	D	16	40	Green (RoHS & no Sb/Br)	CU NIPDAU	Level-1-260C-UNLIM
TSM104WAIDE4	ACTIVE	SOIC	D	16	40	Green (RoHS & no Sb/Br)	CU NIPDAU	Level-1-260C-UNLIM
TSM104WAIDG4	ACTIVE	SOIC	D	16	40	Green (RoHS & no Sb/Br)	CU NIPDAU	Level-1-260C-UNLIM
TSM104WAIDR	ACTIVE	SOIC	D	16	2500	Green (RoHS & no Sb/Br)	CU NIPDAU	Level-1-260C-UNLIM
TSM104WAIDRE4	ACTIVE	SOIC	D	16	2500	Green (RoHS & no Sb/Br)	CU NIPDAU	Level-1-260C-UNLIM
TSM104WAIDRG4	ACTIVE	SOIC	D	16	2500	Green (RoHS & no Sb/Br)	CU NIPDAU	Level-1-260C-UNLIM
TSM104WAIPW	ACTIVE	TSSOP	PW	16	90	Green (RoHS & no Sb/Br)	CU NIPDAU	Level-1-260C-UNLIM
TSM104WAIPWE4	ACTIVE	TSSOP	PW	16	90	Green (RoHS & no Sb/Br)	CU NIPDAU	Level-1-260C-UNLIM
TSM104WAIPWG4	ACTIVE	TSSOP	PW	16	90	Green (RoHS & no Sb/Br)	CU NIPDAU	Level-1-260C-UNLIM
TSM104WAIPWR	ACTIVE	TSSOP	PW	16	2000	Green (RoHS & no Sb/Br)	CU NIPDAU	Level-1-260C-UNLIM
TSM104WAIPWRE4	ACTIVE	TSSOP	PW	16	2000	Green (RoHS & no Sb/Br)	CU NIPDAU	Level-1-260C-UNLIM
TSM104WAIPWRG4	ACTIVE	TSSOP	PW	16	2000	Green (RoHS & no Sb/Br)	CU NIPDAU	Level-1-260C-UNLIM
TSM104WID	ACTIVE	SOIC	D	16	40	Green (RoHS & no Sb/Br)	CU NIPDAU	Level-1-260C-UNLIM
TSM104WIDE4	ACTIVE	SOIC	D	16	40	Green (RoHS & no Sb/Br)	CU NIPDAU	Level-1-260C-UNLIM
TSM104WIDG4	ACTIVE	SOIC	D	16	40	Green (RoHS & no Sb/Br)	CU NIPDAU	Level-1-260C-UNLIM
TSM104WIDR	ACTIVE	SOIC	D	16	2500	Green (RoHS & no Sb/Br)	CU NIPDAU	Level-1-260C-UNLIM
TSM104WIDRE4	ACTIVE	SOIC	D	16	2500	Green (RoHS & no Sb/Br)	CU NIPDAU	Level-1-260C-UNLIM
TSM104WIDRG4	ACTIVE	SOIC	D	16	2500	Green (RoHS & no Sb/Br)	CU NIPDAU	Level-1-260C-UNLIM
TSM104WIPW	ACTIVE	TSSOP	PW	16	90	Green (RoHS & no Sb/Br)	CU NIPDAU	Level-1-260C-UNLIM
TSM104WIPWE4	ACTIVE	TSSOP	PW	16	90	Green (RoHS & no Sb/Br)	CU NIPDAU	Level-1-260C-UNLIM
TSM104WIPWG4	ACTIVE	TSSOP	PW	16	90	Green (RoHS & no Sb/Br)	CU NIPDAU	Level-1-260C-UNLIM
TSM104WIPWR	ACTIVE	TSSOP	PW	16	2000	Green (RoHS & no Sb/Br)	CU NIPDAU	Level-1-260C-UNLIM
TSM104WIPWRE4	ACTIVE	TSSOP	PW	16	2000	Green (RoHS & no Sb/Br)	CU NIPDAU	Level-1-260C-UNLIM
TSM104WIPWRG4	ACTIVE	TSSOP	PW	16	2000	Green (RoHS & no Sb/Br)	CU NIPDAU	Level-1-260C-UNLIM

⁽¹⁾ The marketing status values are defined as follows:

ACTIVE: Product device recommended for new designs.

LIFEBUY: TI has announced that the device will be discontinued, and a lifetime-buy period is in effect.

NRND: Not recommended for new designs. Device is in production to support existing customers, but TI does not recommend using this part in a new design.

PREVIEW: Device has been announced but is not in production. Samples may or may not be available.

OBSOLETE: TI has discontinued the production of the device.

⁽²⁾ Eco Plan - The planned eco-friendly classification: Pb-Free (RoHS), Pb-Free (RoHS Exempt), or Green (RoHS & no Sb/Br) - please check <http://www.ti.com/productcontent> for the latest availability information and additional product content details.

TBD: The Pb-Free/Green conversion plan has not been defined.

Pb-Free (RoHS): TI's terms "Lead-Free" or "Pb-Free" mean semiconductor products that are compatible with the current RoHS requirements for all 6 substances, including the requirement that lead not exceed 0.1% by weight in homogeneous materials. Where designed to be soldered at high temperatures, TI Pb-Free products are suitable for use in specified lead-free processes.

Pb-Free (RoHS Exempt): This component has a RoHS exemption for either 1) lead-based flip-chip solder bumps used between the die and package, or 2) lead-based die adhesive used between the die and leadframe. The component is otherwise considered Pb-Free (RoHS compatible) as defined above.

Green (RoHS & no Sb/Br): TI defines "Green" to mean Pb-Free (RoHS compatible), and free of Bromine (Br) and Antimony (Sb) based flame retardants (Br or Sb do not exceed 0.1% by weight in homogeneous material)

⁽³⁾ MSL, Peak Temp. -- The Moisture Sensitivity Level rating according to the JEDEC industry standard classifications, and peak solder temperature.

Important Information and Disclaimer:The information provided on this page represents TI's knowledge and belief as of the date that it is provided. TI bases its knowledge and belief on information provided by third parties, and makes no representation or warranty as to the accuracy of such information. Efforts are underway to better integrate information from third parties. TI has taken and continues to take reasonable steps to provide representative and accurate information but may not have conducted destructive testing or chemical analysis on incoming materials and chemicals. TI and TI suppliers consider certain information to be proprietary, and thus CAS numbers and other limited information may not be available for release.

In no event shall TI's liability arising out of such information exceed the total purchase price of the TI part(s) at issue in this document sold by TI to Customer on an annual basis.

TAPE AND REEL INFORMATION
REEL DIMENSIONS

TAPE DIMENSIONS

A0	Dimension designed to accommodate the component width
B0	Dimension designed to accommodate the component length
K0	Dimension designed to accommodate the component thickness
W	Overall width of the carrier tape
P1	Pitch between successive cavity centers

TAPE AND REEL INFORMATION

*All dimensions are nominal

Device	Package Type	Package Drawing	Pins	SPQ	Reel Diameter (mm)	Reel Width W1 (mm)	A0 (mm)	B0 (mm)	K0 (mm)	P1 (mm)	W (mm)	Pin1 Quadrant
TSM104WAIDR	SOIC	D	16	2500	330.0	16.4	6.5	10.3	2.1	8.0	16.0	Q1
TSM104WAIPWR	TSSOP	PW	16	2000	330.0	12.4	6.9	5.6	1.6	8.0	12.0	Q1
TSM104WIDR	SOIC	D	16	2500	330.0	16.4	6.5	10.3	2.1	8.0	16.0	Q1
TSM104WIPWR	TSSOP	PW	16	2000	330.0	12.4	6.9	5.6	1.6	8.0	12.0	Q1

TAPE AND REEL BOX DIMENSIONS



*All dimensions are nominal

Device	Package Type	Package Drawing	Pins	SPQ	Length (mm)	Width (mm)	Height (mm)
TSM104WAIDR	SOIC	D	16	2500	367.0	367.0	38.0
TSM104WAIPWR	TSSOP	PW	16	2000	367.0	367.0	35.0
TSM104WIDR	SOIC	D	16	2500	367.0	367.0	38.0
TSM104WIPWR	TSSOP	PW	16	2000	367.0	367.0	35.0

D (R-PDSO-G16)

PLASTIC SMALL OUTLINE



- NOTES:
- A. All linear dimensions are in inches (millimeters).
 - B. This drawing is subject to change without notice.
 - C. Body length does not include mold flash, protrusions, or gate burrs. Mold flash, protrusions, or gate burrs shall not exceed 0.006 (0,15) each side.
 - D. Body width does not include interlead flash. Interlead flash shall not exceed 0.017 (0,43) each side.
 - E. Reference JEDEC MS-012 variation AC.

D (R-PDSO-G16)

PLASTIC SMALL OUTLINE

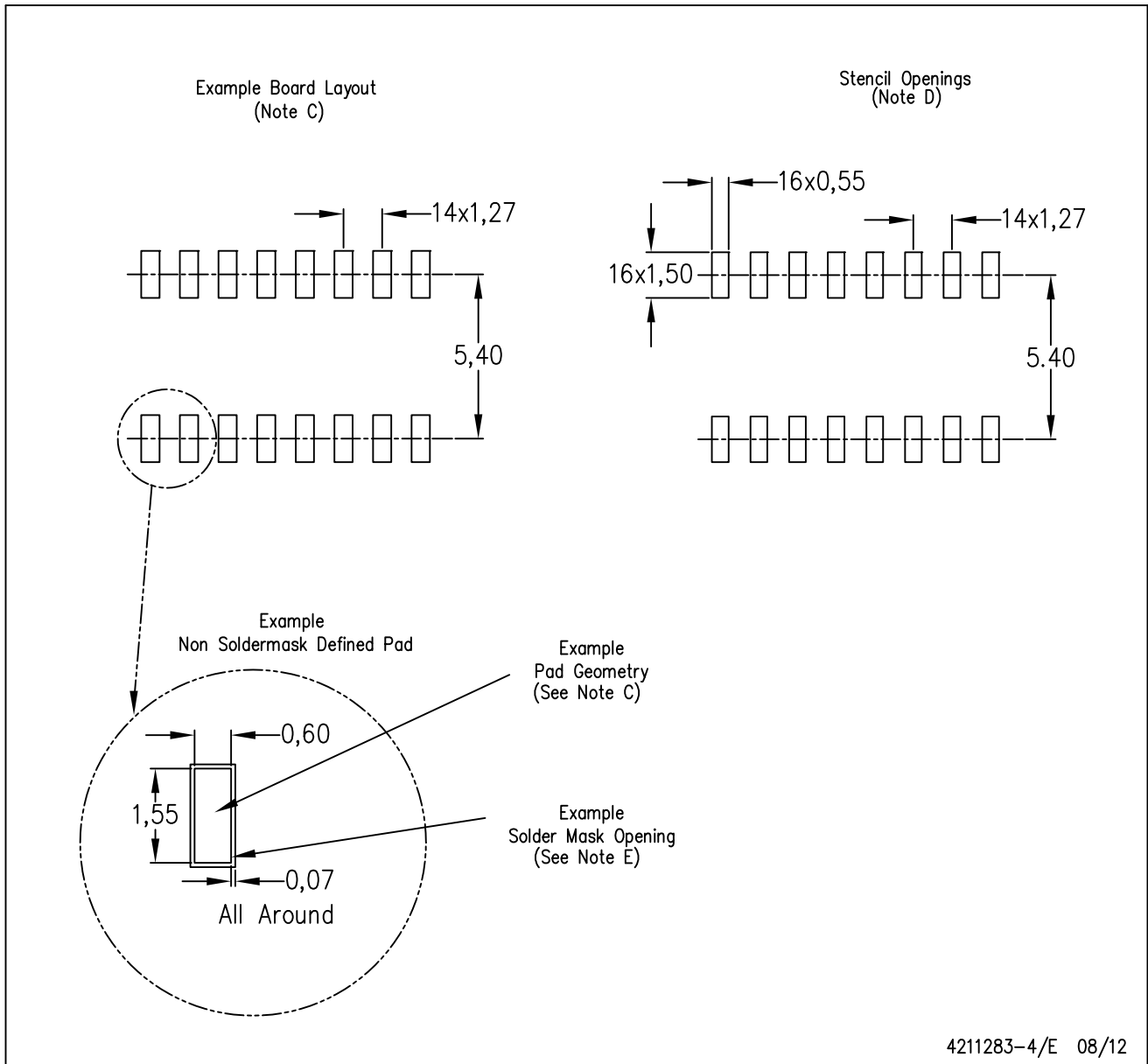

- NOTES:
- All linear dimensions are in millimeters.
 - This drawing is subject to change without notice.
 - Publication IPC-7351 is recommended for alternate designs.
 - Laser cutting apertures with trapezoidal walls and also rounding corners will offer better paste release. Customers should contact their board assembly site for stencil design recommendations. Refer to IPC-7525 for other stencil recommendations.
 - Customers should contact their board fabrication site for solder mask tolerances between and around signal pads.

PW (R-PDSO-G16)

PLASTIC SMALL OUTLINE



- NOTES:
- A. All linear dimensions are in millimeters. Dimensioning and tolerancing per ASME Y14.5M-1994.
 - B. This drawing is subject to change without notice.
 - C. Body length does not include mold flash, protrusions, or gate burrs. Mold flash, protrusions, or gate burrs shall not exceed 0,15 each side.
 - D. Body width does not include interlead flash. Interlead flash shall not exceed 0,25 each side.
 - E. Falls within JEDEC MO-153

PW (R-PDSO-G16)

PLASTIC SMALL OUTLINE

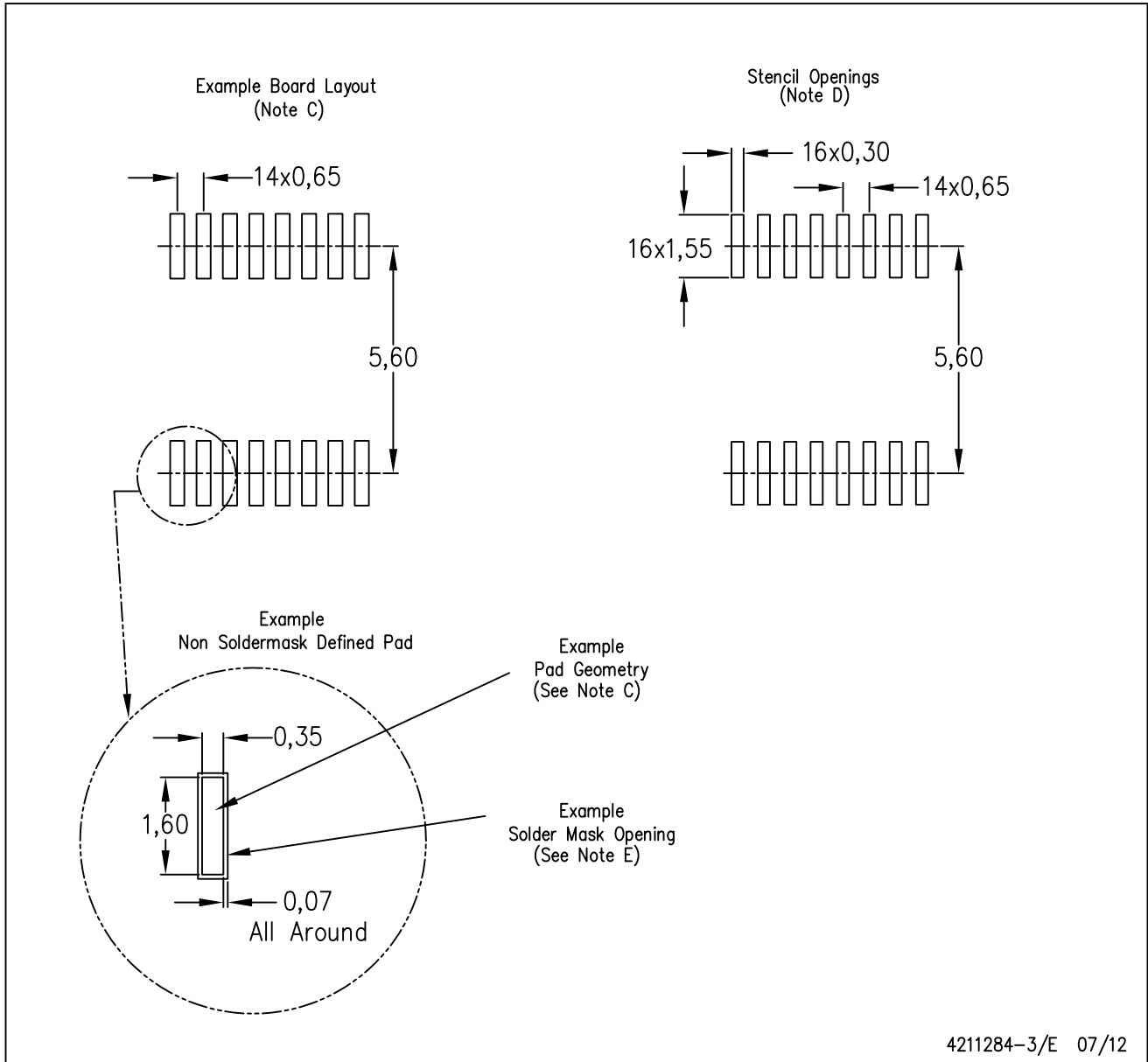

- NOTES:
- All linear dimensions are in millimeters.
 - This drawing is subject to change without notice.
 - Publication IPC-7351 is recommended for alternate designs.
 - Laser cutting apertures with trapezoidal walls and also rounding corners will offer better paste release. Customers should contact their board assembly site for stencil design recommendations. Refer to IPC-7525 for other stencil recommendations.
 - Customers should contact their board fabrication site for solder mask tolerances between and around signal pads.

IMPORTANT NOTICE

Texas Instruments Incorporated and its subsidiaries (TI) reserve the right to make corrections, enhancements, improvements and other changes to its semiconductor products and services per JESD46C and to discontinue any product or service per JESD48B. Buyers should obtain the latest relevant information before placing orders and should verify that such information is current and complete. All semiconductor products (also referred to herein as "components") are sold subject to TI's terms and conditions of sale supplied at the time of order acknowledgment.

TI warrants performance of its components to the specifications applicable at the time of sale, in accordance with the warranty in TI's terms and conditions of sale of semiconductor products. Testing and other quality control techniques are used to the extent TI deems necessary to support this warranty. Except where mandated by applicable law, testing of all parameters of each component is not necessarily performed.

TI assumes no liability for applications assistance or the design of Buyers' products. Buyers are responsible for their products and applications using TI components. To minimize the risks associated with Buyers' products and applications, Buyers should provide adequate design and operating safeguards.

TI does not warrant or represent that any license, either express or implied, is granted under any patent right, copyright, mask work right, or other intellectual property right relating to any combination, machine, or process in which TI components or services are used. Information published by TI regarding third-party products or services does not constitute a license to use such products or services or a warranty or endorsement thereof. Use of such information may require a license from a third party under the patents or other intellectual property of the third party, or a license from TI under the patents or other intellectual property of TI.

Reproduction of significant portions of TI information in TI data books or data sheets is permissible only if reproduction is without alteration and is accompanied by all associated warranties, conditions, limitations, and notices. TI is not responsible or liable for such altered documentation. Information of third parties may be subject to additional restrictions.

Resale of TI components or services with statements different from or beyond the parameters stated by TI for that component or service voids all express and any implied warranties for the associated TI component or service and is an unfair and deceptive business practice. TI is not responsible or liable for any such statements.

Buyer acknowledges and agrees that it is solely responsible for compliance with all legal, regulatory and safety-related requirements concerning its products, and any use of TI components in its applications, notwithstanding any applications-related information or support that may be provided by TI. Buyer represents and agrees that it has all the necessary expertise to create and implement safeguards which anticipate dangerous consequences of failures, monitor failures and their consequences, lessen the likelihood of failures that might cause harm and take appropriate remedial actions. Buyer will fully indemnify TI and its representatives against any damages arising out of the use of any TI components in safety-critical applications.

In some cases, TI components may be promoted specifically to facilitate safety-related applications. With such components, TI's goal is to help enable customers to design and create their own end-product solutions that meet applicable functional safety standards and requirements. Nonetheless, such components are subject to these terms.

No TI components are authorized for use in FDA Class III (or similar life-critical medical equipment) unless authorized officers of the parties have executed a special agreement specifically governing such use.

Only those TI components which TI has specifically designated as military grade or "enhanced plastic" are designed and intended for use in military/aerospace applications or environments. Buyer acknowledges and agrees that any military or aerospace use of TI components which have **not** been so designated is solely at the Buyer's risk, and that Buyer is solely responsible for compliance with all legal and regulatory requirements in connection with such use.

TI has specifically designated certain components which meet ISO/TS16949 requirements, mainly for automotive use. Components which have not been so designated are neither designed nor intended for automotive use; and TI will not be responsible for any failure of such components to meet such requirements.

Products

Audio	www.ti.com/audio
Amplifiers	amplifier.ti.com
Data Converters	dataconverter.ti.com
DLP® Products	www.dlp.com
DSP	dsp.ti.com
Clocks and Timers	www.ti.com/clocks
Interface	interface.ti.com
Logic	logic.ti.com
Power Mgmt	power.ti.com
Microcontrollers	microcontroller.ti.com
RFID	www.ti-rfid.com
OMAP Mobile Processors	www.ti.com/omap
Wireless Connectivity	www.ti.com/wirelessconnectivity

Applications

Automotive and Transportation	www.ti.com/automotive
Communications and Telecom	www.ti.com/communications
Computers and Peripherals	www.ti.com/computers
Consumer Electronics	www.ti.com/consumer-apps
Energy and Lighting	www.ti.com/energy
Industrial	www.ti.com/industrial
Medical	www.ti.com/medical
Security	www.ti.com/security
Space, Avionics and Defense	www.ti.com/space-avionics-defense
Video and Imaging	www.ti.com/video

TI E2E Community e2e.ti.com