



TS820-B/T

SENSITIVE SCR

FEATURES

- $I_{T(RMS)} = 8A$
- $V_{DRM}/V_{RRM} = 400, 600V, 700V$
- $I_{GT} < 200\mu A$
- SMD PACKAGE

DESCRIPTION

The TS820-B/T series of SCR use a high performance TOPGLASS PNP technology.

The parts are intended for general purpose applications using surface mount or through hole technology.

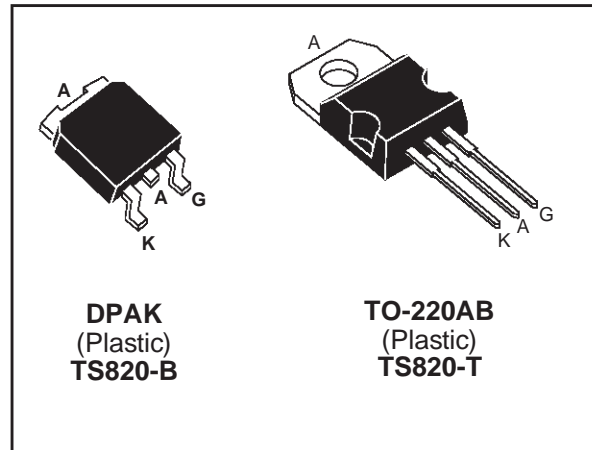

ABSOLUTE RATINGS (limiting values)

Symbol	Parameter		Value	Unit
$I_{T(RMS)}$	RMS on-state current (180° conduction angle)	$T_c = 110^\circ C$	8	A
$I_{T(AV)}$	Average on-state current (180° conduction angle)	$T_c = 110^\circ C$	5	A
I_{TSM}	Non repetitive surge peak on-state current (T_j initial = 25°C)	$t_p = 8.3ms$ $t_p = 10ms$	73 70	A
I^2t	I^2t Value for fusing	$t_p = 10ms$	24	A ² s
di/dt	Critical rate of rise of on-state current $I_G = 10 mA$ $di_G/dt = 0.1 A/\mu s$.		100	A/ μs
T_{stg} T_j	Storage junction temperature range Operating junction temperature range		- 40 to + 150 - 40 to + 125	°C
TI	Maximum temperature for soldering during 10s		260	°C

Symbol	Parameter	TS820-			Unit
		400B/T	600B/T	700B/T	
V_{DRM}	Repetitive peak off-state voltage	400	600	700	V
V_{RRM}	$T_j = 125^\circ C$ $R_{GK} = 220 \Omega$				

TS820-B/T

THERMAL RESISTANCES

Symbol	Parameter		Value	Unit
Rth(j-a)	Junction to ambient (S=0.5cm ²)	DPAK	70	°C/W
		TO-220AB	60	
Rth(j-c)	Junction to case for DC	DPAK / TO-220AB	2.0	°C/W

GATE CHARACTERISTICS (maximum values)

$P_G (AV) = 0.2 \text{ W}$ $P_{GM} = 3 \text{ W}$ ($t_p = 20 \mu\text{s}$) $I_{GM} = 1.2 \text{ A}$ ($t_p = 20 \mu\text{s}$)

ELECTRICAL CHARACTERISTICS

Symbol	Test Conditions		Type	Value	Unit
I_{GT}	$V_D = 12\text{V (DC)}$ $R_L = 140\Omega$	$T_j = 25^\circ\text{C}$	MAX	200	μA
V_{GT}	$V_D = 12\text{V (DC)}$ $R_L = 140\Omega$	$T_j = 25^\circ\text{C}$	MAX	0.8	V
V_{GD}	$V_D = V_{DRM}$ $R_L = 3.3\text{k}\Omega$ $R_{GK} = 220\Omega$	$T_j = 125^\circ\text{C}$	MIN	0.1	V
V_{RG}	$I_{RG} = 10\mu\text{A}$	$T_j = 25^\circ\text{C}$	MIN	8	V
I_H	$I_T = 50\text{mA}$ $R_{GK} = 1\text{K}\Omega$	$T_j = 25^\circ\text{C}$	MAX	5	mA
V_{TM}	$I_{TM} = 16\text{A}$ $t_p = 380\mu\text{s}$	$T_j = 25^\circ\text{C}$	MAX	1.6	V
I_{DRM}	$V_D = V_{DRM}$ $R_{GK} = 220\Omega$	$T_j = 25^\circ\text{C}$	MAX	5	μA
I_{RRM}	$V_R = V_{RRM}$ $R_{GK} = 220\Omega$	$T_j = 125^\circ\text{C}$	MAX	1	mA
dV/dt	$V_D = 67\%V_{DRM}$ $R_{GK} = 220\Omega$	$T_j = 125^\circ\text{C}$	MIN	5	V/ μs

ORDERING INFORMATION Add "-TR" suffix for Tape & Reel shipment

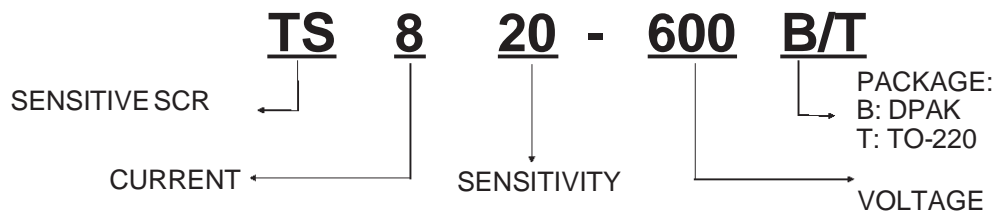

Fig. 1: Maximum average power dissipation versus average on-state current.

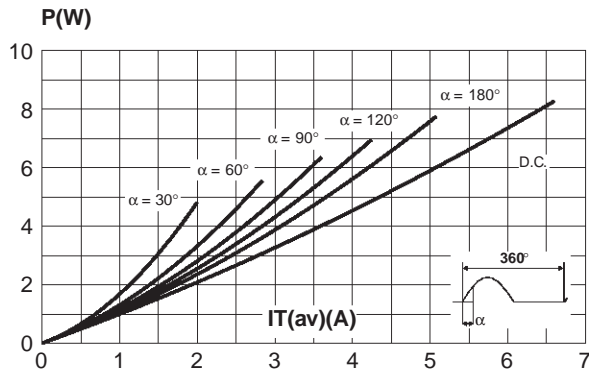

Fig. 2: Correlation between maximum average power dissipation and maximum allowable temperatures (Tamb and Tcase) for different thermal resistances heatsink + contact.

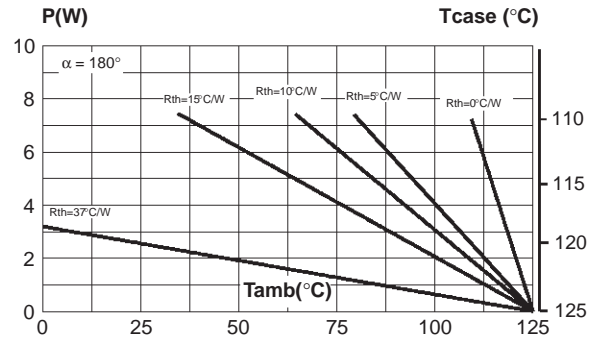

Fig. 3-1: Average and D.C. on-state current versus case temperature (TO-220AB).

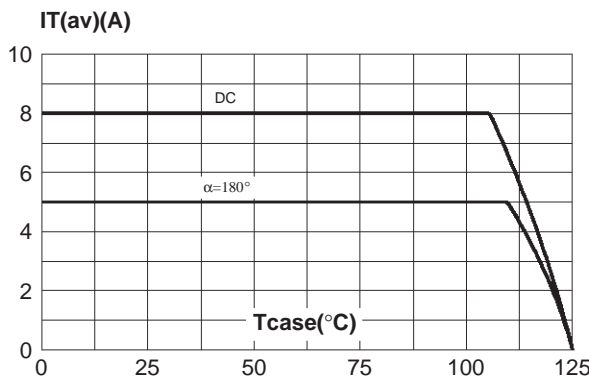

Fig. 3-2: Average and D.C. on-state current versus ambient temperature (device mounted on FR4 with recommended pad layout) (DPAK).

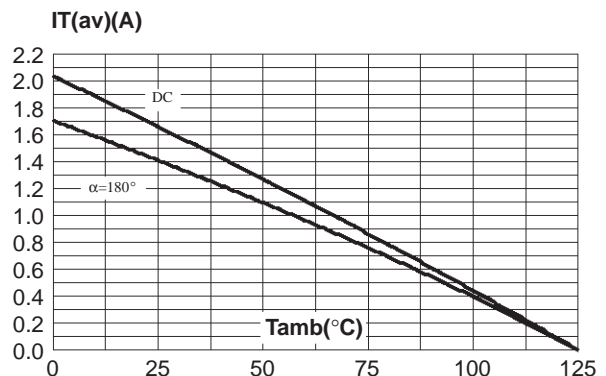

Fig. 4-1: Relative variation of thermal impedance junction to case versus pulse duration.

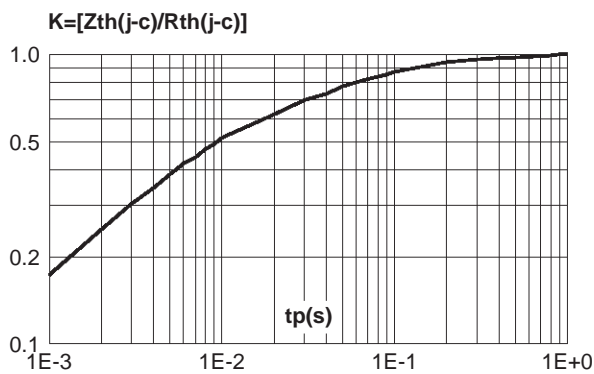

Fig. 4-5: Relative variation of thermal impedance junction to ambient versus pulse duration (recommended pad layout, FR4 PC board) (DPAK).

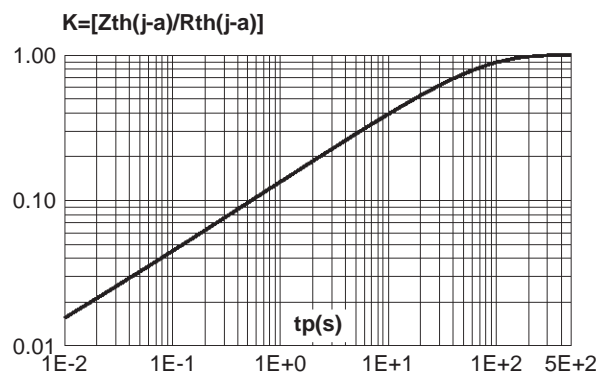

Fig. 5: Relative variation of gate trigger current and holding current versus junction temperature.

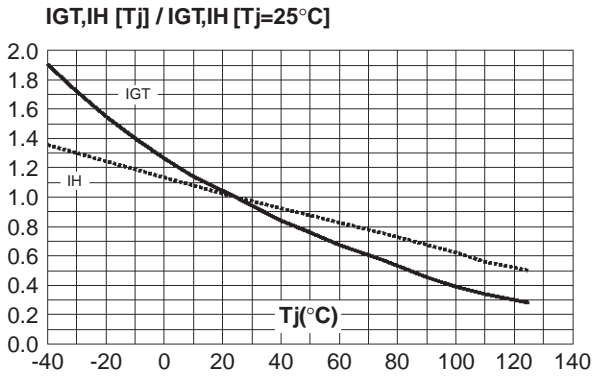

Fig. 6: Non repetitive surge peak on-state current versus number of cycles.

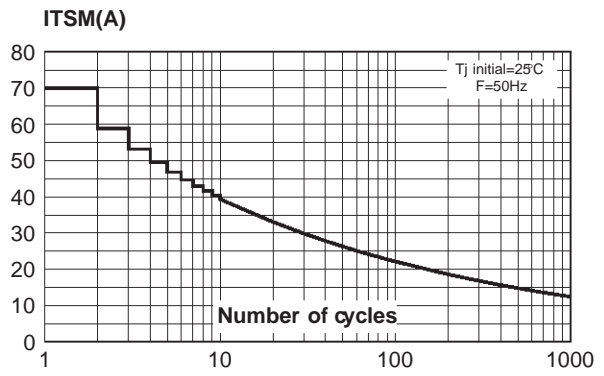

Fig. 7: Non repetitive surge peak on-state current for a sinusoidal pulse with width $tp < 10ms$, and corresponding value of I^2t .

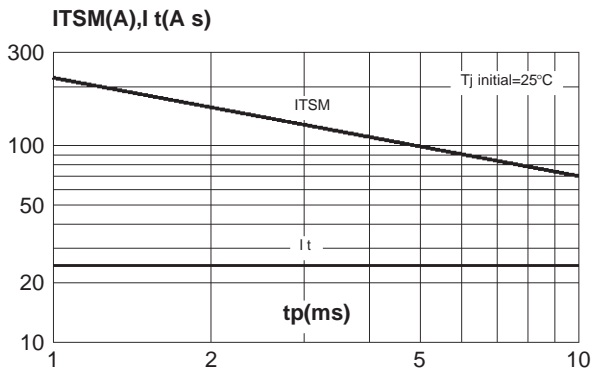

Fig. 8: On-state characteristics (maximum values).

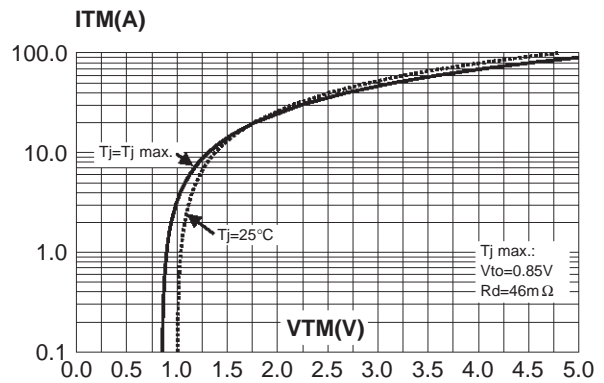

Fig. 9: Thermal resistance junction to ambient versus copper surface under tab (Epoxy printed circuit board FR4, copper thickness: 35μm) (DPAK).

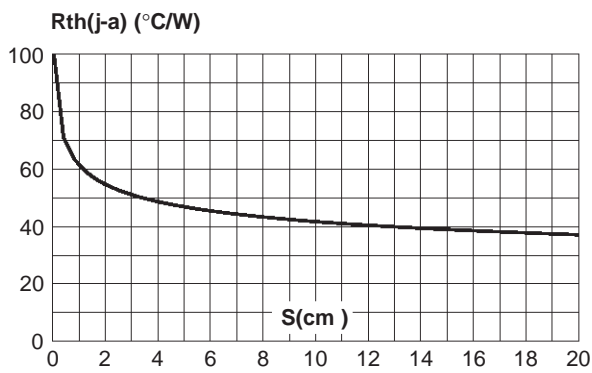
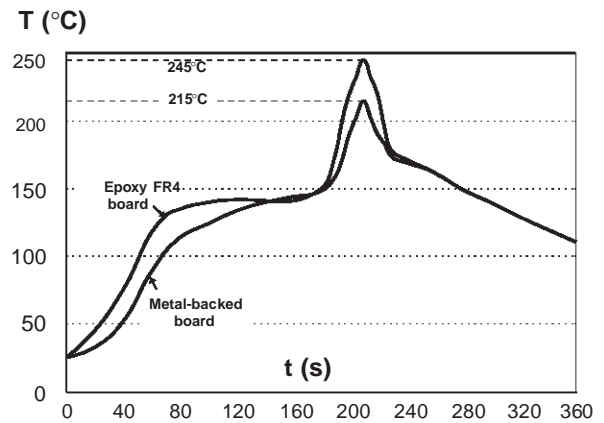
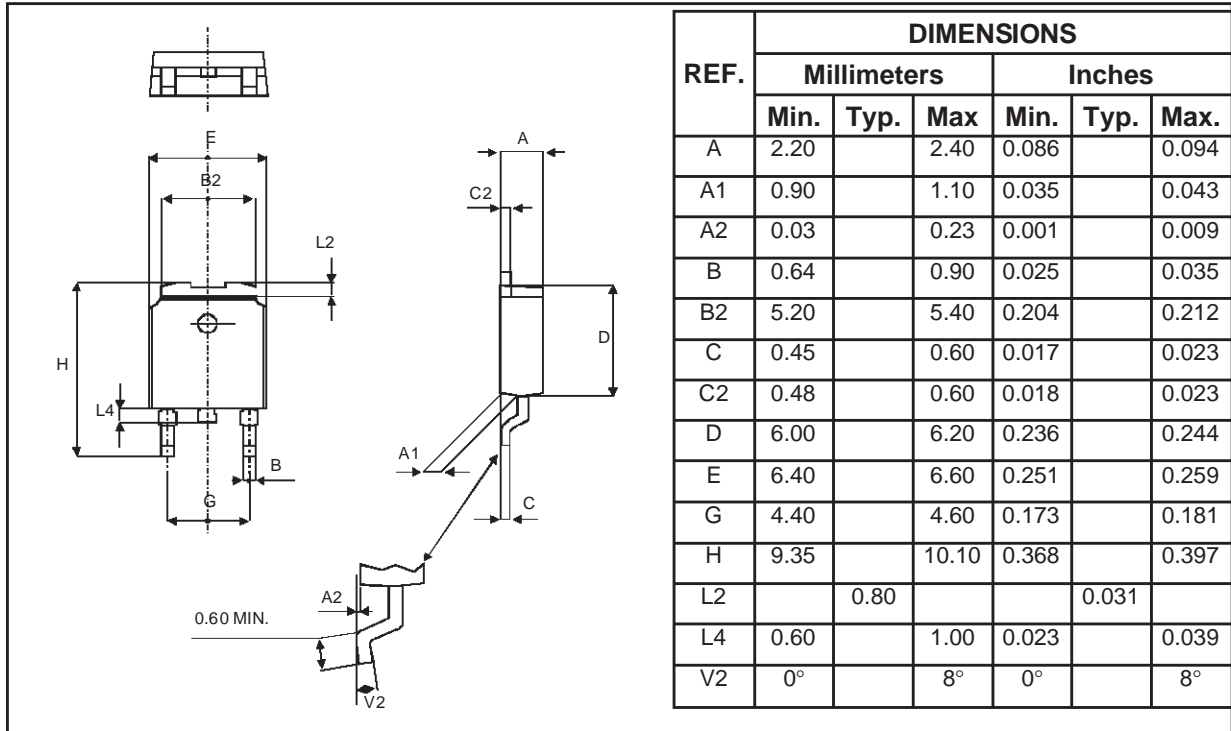

Fig. 10: Typical reflow soldering heat profile, either for mounting on FR4 or metal-backed boards.



PACKAGE MECHANICAL DATA
DPAK (Plastic)



FOOT PRINT DIMENSIONS (in millimeters)

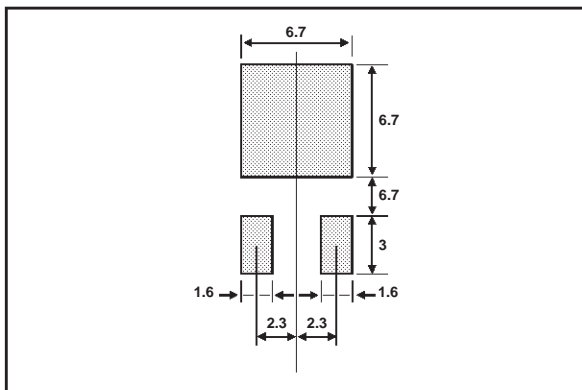

TS820-B/T

PACKAGE MECHANICAL DATA

TO-220AB(Plastic)

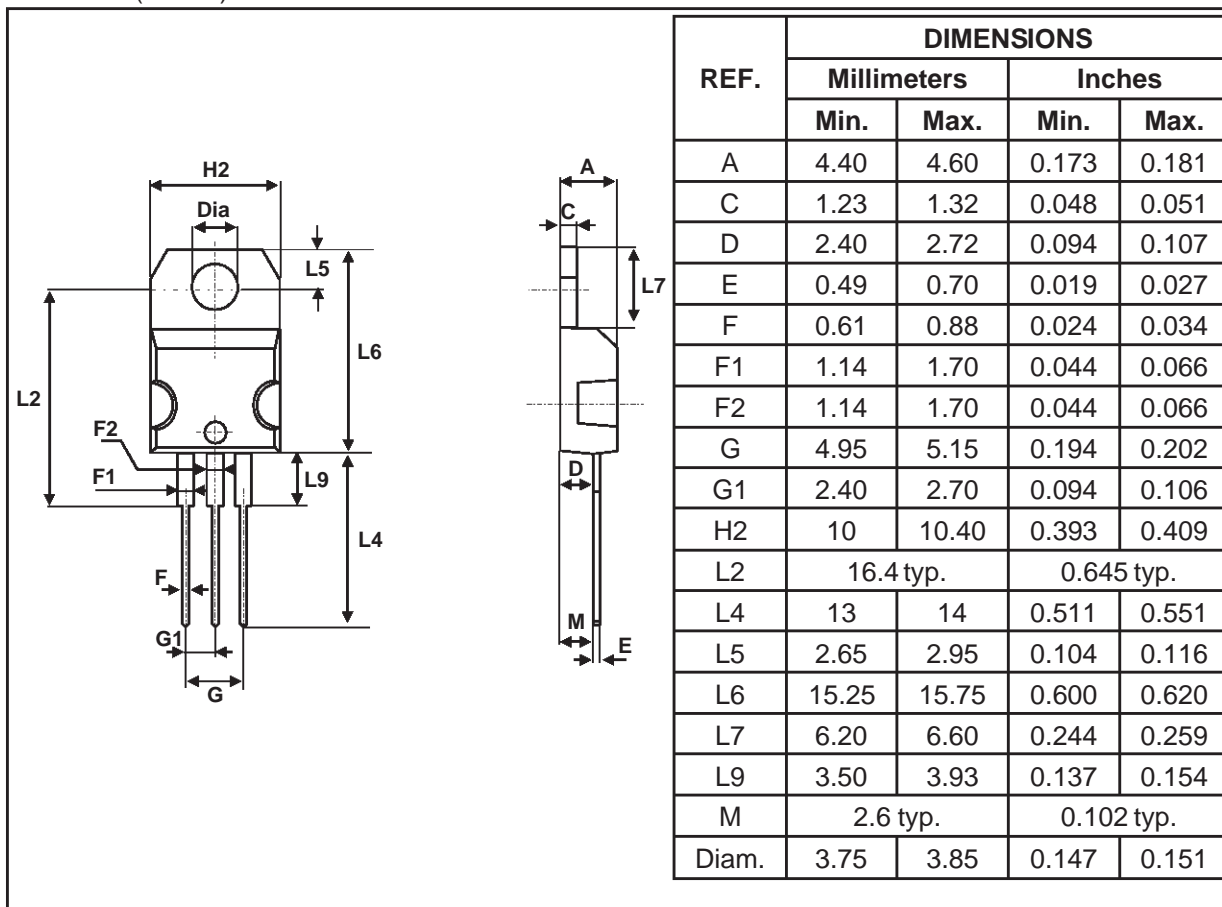

Type	Marking	Package	Weight	Base qty	Delivery mode
TS820-B	TS820x00B	DPAK	0.3 g.	75	Tube
				2500	Tape and Reel
TS820-T	TS820x00T	TO-220AB	2 g.	50	Tube

Information furnished is believed to be accurate and reliable. However, STMicroelectronics assumes no responsibility for the consequences of use of such information nor for any infringement of patents or other rights of third parties which may result from its use. No license is granted by implication or otherwise under any patent or patent rights of STMicroelectronics. Specifications mentioned in this publication are subject to change without notice. This publication supersedes and replaces all information previously supplied.

STMicroelectronics products are not authorized for use as critical components in life support devices or systems without express written approval of STMicroelectronics.

The ST logo is a registered trademark of STMicroelectronics

© 1998 STMicroelectronics - Printed in Italy - All rights reserved.

STMicroelectronics GROUP OF COMPANIES

Australia - Brazil - Canada - China - France - Germany - Italy - Japan - Korea - Malaysia - Malta - Mexico - Morocco - The Netherlands - Singapore - Spain - Sweden - Switzerland - Taiwan - Thailand - United Kingdom - U.S.A.

<http://www.st.com>