

## CMOS QUAD OPERATIONAL AMPLIFIERS

- EXCELLENT PHASE MARGIN ON CAPACITIVE LOADS
- SYMMETRICAL OUTPUT CURRENTS
- HIGH GAIN BANDWIDTH PRODUCT FOR TS274
- LOW OUTPUT DYNAMIC IMPEDANCE
- THE TRANSFER FUNCTION IS LINEAR
- PIN COMPATIBLE TO STANDARD QUAD OPERATIONAL AMPLIFIERS (TL084-LM324)
- STABLE AND LOW OFFSET VOLTAGE
- INTERNAL ELECTROSTATIC DISCHARGE (ESD) PROTECTION CIRCUITS
- THREE INPUT OFFSET VOLTAGE SELECTIONS : STANDARD (10 mV), A (5 mV), B (2 mV)

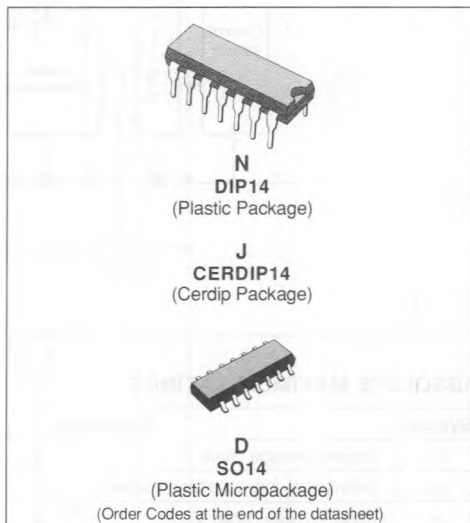

### DESCRIPTION

The TS274 series are low cost, low power quad operational amplifiers designed to operate with single or dual supplies. These operational amplifiers use the SGS-THOMSON Microelectronics silicon gate LIN MOS process giving them an excellent consumption-speed ratio. These series are ideally suited for low consumption applications.

Three power consumptions are available allowing to have always the best consumption-speed ratio.

- $I_{CC} = 10 \mu\text{A}$  per amplifier : TS27L4 (Low bias versions)
- $I_{CC} = 150 \mu\text{A}$  per amplifier : TS27M4 (Medium bias versions)
- $I_{CC} = 1 \text{mA}$  per amplifier : TS274 (High bias versions)

The input impedance is similar to the J-FET input impedance : very high input impedance and extremely low input offset and bias currents. They allow to minimize the static errors in low impedance applications.

### PIN CONNECTIONS (top view)

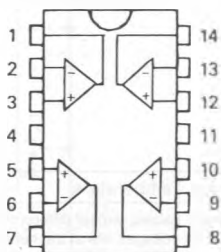

- E88TS274-01
- 1 - Output 1
  - 2 - Inverting input 1
  - 3 - Non-inverting input 1
  - 4 -  $V_{CC}^+$
  - 5 - Non-inverting input 2
  - 6 - Inverting input 2
  - 7 - Output 2
  - 8 - Output 3
  - 9 - Inverting input 3
  - 10 - Non-inverting input 3
  - 11 -  $V_{CC}^-$
  - 12 - Non-inverting input 4
  - 13 - Inverting input 4
  - 14 - Output 4

BLOCK DIAGRAM

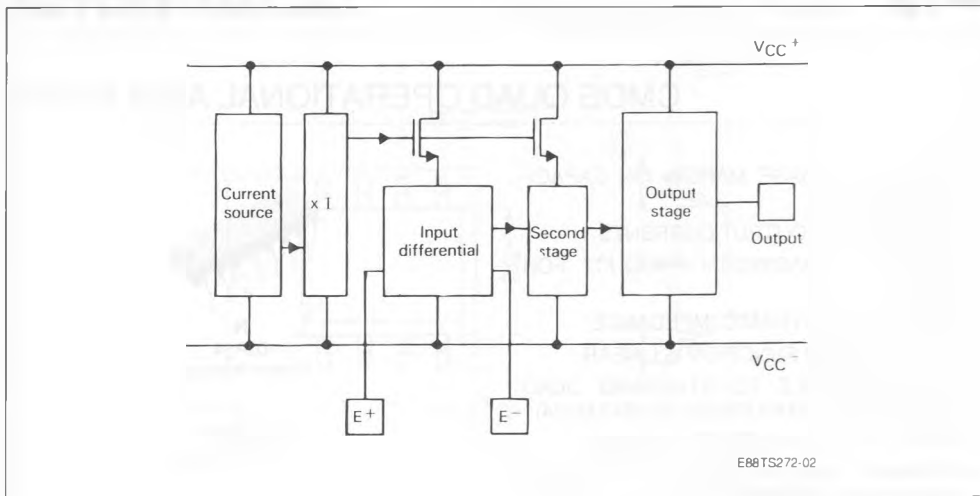

ABSOLUTE MAXIMUM RATINGS

Symbol	Parameter	Value	Unit
$V_{CC}$	Supply Voltage (note 1)	12	V
$V_{id}$	Differential Input Voltage (note 2)	$\pm 12$	V
$V_i$	Input Voltage (note 3)	- 0.3 to 12	V
$T_{oper}$	Operating Free-air Temperature	TS274C 0 to 70 TS274I - 40 to 105 TS274M - 55 to 125 TS27M4C 0 to 70 TS27M4I - 40 to 105 TS27M4M - 55 to 125 TS27L4C 0 to 70 TS27L4I - 40 to 105 TS27L4M - 55 to 125	$^{\circ}C$
$T_{stg}$	Storage Temperature	- 65 to 150	$^{\circ}C$

- Notes : 1. All voltage values, except differential voltages, are with respect to network ground terminal.  
 2. Differential voltages are at the noninverting input terminal with respect to the input terminal.  
 3. The magnitude of the input voltage must never exceed the magnitude of the positive supply voltage.

OPTIMAL OPERATING CONDITIONS

Symbol	Parameter	Value	Unit
$V_{CC}$	Supply Voltage (note 1)	4 to 10	V
$V_i$	Common Mode Input Voltage $V_{CC} = 10$ V	0 to 9	V

SCHEMATIC DIAGRAM (for 1/4 TS27 x 4)

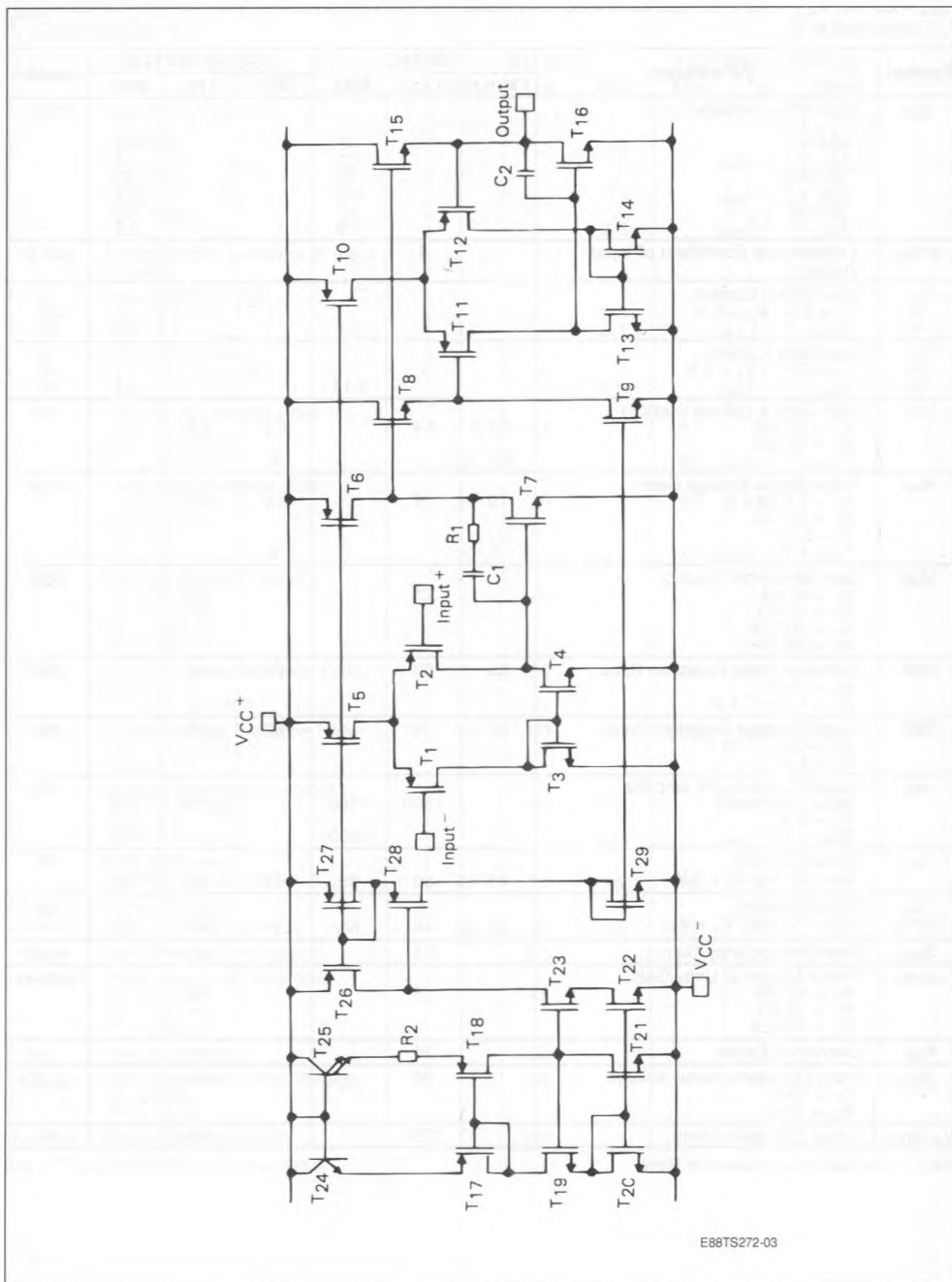

E88TS272-03

**ELECTRICAL CHARACTERISTICS FOR TS274**

$T_{amb} = 25\text{ }^{\circ}\text{C}$ ,  $V_{CC} = 10\text{ V}$  (unless otherwise specified)

$R_L$  Connected to  $V_{CC}$

Symbol	Parameter	TS274C			TS274I/TS274M			Unit
		Min.	Typ.	Max.	Min.	Typ.	Max.	
$V_{io}$	Input Offset Voltage $V_o = 1.4\text{ V}$ TS274 $T_{min} < T < T_{max}$ TS274A $T_{min} < T < T_{max}$ TS274B $T_{min} < T < T_{max}$			10 12 5 6.5 2 3.5			10 12 5 6.5 2 3.5	mV
$\alpha V_{io}$	Temperature Coefficient of Input Voltage		5			5		$\mu\text{V}/^{\circ}\text{C}$
$I_{io}$	Input Offset Current $V_i = 5\text{ V}$ , $V_o = 5\text{ V}$ $T_{min} < T < T_{max}$		1	0.1		1	0.2	$\mu\text{A}$ nA
$I_b$	Input Bias Current $V_i = 5\text{ V}$ , $V_o = 5\text{ V}$ $T_{min} < T < T_{max}$		1	0.15		1	0.3	$\mu\text{A}$ nA
$V_{DH}$	High Output Voltage (note 1) $V_i = 10\text{ mV}$ $R_L = 10\text{ k}\Omega$ $T_{min} < T < T_{max}$	8.2 8.1	8.4		8.2 8	8.4		V
$A_{vd}$	Large Signal Voltage Gain $V_o = 1\text{ V to }6\text{ V}$ $R_L = 10\text{ k}\Omega$ $V_i = 5\text{ V}$ $T_{min} < T < T_{max}$	10 7	15		10 6	15		V/mV
$G_{wr}$	Gain Bandwidth Product $A_v = 40\text{ dB}$ $R_L = 10\text{ k}\Omega$ $C_L = 100\text{ pF}$ $f_{in} = 200\text{ KHz}$		3.5			3.5		MHz
CMR	Common Mode Rejection Ratio $V_o = 1.4\text{ V}$ $V_i = 1\text{ V to }7.4\text{ V}$	65	80		65	80		dB
SVR	Supply Voltage Rejection Ratio $V_{CC} = 5\text{ V to }10\text{ V}$ $V_o = 1.4\text{ V}$	60	70		60	70		dB
$I_{CC}$	Supply Current (per amplifier) $A_v = 1$ , no Load $V_o = 5\text{ V}$ $T_{min} < T < T_{max}$		1000	1500 1600		1000	1500 1700	$\mu\text{A}$
$I_s$	Output Current $V_i = 10\text{ mV}$ , $V_o = 0\text{ V}$	45	60	85	45	60	85	mA
$I_s$ (Sink)	Output Current $V_i = -10\text{ mV}$ , $V_o = V_{CC}$	35	45	65	35	45	65	mA
$S_{VO}$	Slew Rate at Unity Gain		5.5			5.5		V/ $\mu\text{S}$
$\phi_m$	Phase Margin at Unity Gain $A_v = 40\text{ dB}$ $R_L = 10\text{ k}\Omega$ $C_L = 100\text{ pF}$		45			45		Degrees
$K_{OV}$	Overshoot Factor		30			30		%
$V_n$	Input Equivalent Noise Voltage $f = 1\text{ KHz}$ $R_S = 10\text{ }\Omega$		30			30		nV/ $\sqrt{\text{Hz}}$
$V_{O1}/V_{O2}$	Cross Talk Attenuation		120			120		dB

Note : 1. Low output voltage is less than 50mV.

## ELECTRICAL CHARACTERISTICS FOR TS27M4

 $T_{amb} = 25\text{ }^{\circ}\text{C}$ ,  $V_{CC} = 10\text{ V}$  (unless otherwise specified)

 $R_L$  Connected to  $V_{CC}$ 

Symbol	Parameter	TS27M4C			TS27M4I/TS27M4M			Unit
		Min.	Typ.	Max.	Min.	Typ.	Max.	
$V_{io}$	Input Offset Voltage $V_o = 1.4\text{ V}$ TS27M4 $T_{min} < T < T_{max}$ TS27M4A $T_{min} < T < T_{max}$ TS27M4B $T_{min} < T < T_{max}$			10 12 5 6.5 2 3.5			10 12 5 6.5 2 3.5	mV
$\alpha V_{io}$	Temperature Coefficient of Input Voltage		2			2		$\mu\text{V}/^{\circ}\text{C}$
$I_{io}$	Input Offset Current $V_i = 5\text{ V}$ , $V_o = 5\text{ V}$ $T_{min} < T < T_{max}$		1	0.1		1	0.2	$\mu\text{A}$ nA
$I_b$	Input Bias Current $V_i = 5\text{ V}$ , $V_o = 5\text{ V}$ $T_{min} < T < T_{max}$		1	0.15		1	0.3	$\mu\text{A}$ nA
$V_{DH}$	High Output Voltage (note 1) $V_i = 10\text{ mV}$ $R_L = 100\text{ k}\Omega$ $T_{min} < T < T_{max}$	8.7 8.6	8.9		8.7 8.5	8.9		V
$A_{vd}$	Large Signal Voltage Gain $V_o = 1\text{ V to } 6\text{ V}$ $R_L = 100\text{ k}\Omega$ $V_i = 5\text{ V}$ $T_{min} < T < T_{max}$	30 20	50		30 10	50		V/mV
$G_{wr}$	Gain Bandwidth Product $A_v = 40\text{ dB}$ $R_L = 100\text{ k}\Omega$ $C_L = 100\text{ pF}$ $f_{in} = 100\text{ KHz}$		1			1		MHz
CMR	Common Mode Rejection Ratio $V_o = 1.4\text{ V}$ $V_i = 1\text{ V to } 7.4\text{ V}$	65	80		65	80		dB
SVR	Supply Voltage Rejection Ratio $V_{CC} = 5\text{ V to } 10\text{ V}$ $V_o = 1.4\text{ V}$	60	80		60	80		dB
$I_{CC}$	Supply Current (per amplifier) $A_v = 1$ , no Load $V_o = 5\text{ V}$ $T_{min} < T < T_{max}$		150	200 250		150	200 300	$\mu\text{A}$
$I_s$	Output Current $V_i = 10\text{ mV}$ , $V_o = 0\text{ V}$	45	60	85	45	60	85	mA
$I_s$ (Sink)	Output Current $V_i = -10\text{ mV}$ , $V_o = V_{CC}$	35	45	65	35	45	65	mA
$S_{V_O}$	Slew Rate at Unity Gain		0.6			0.6		V/ $\mu\text{S}$
$\phi_m$	Phase Margin at Unity Gain $A_v = 40\text{ dB}$ $R_L = 100\text{ k}\Omega$ $C_L = 100\text{ pF}$		45			45		Degrees
$K_{OV}$	Overshoot Factor		30			30		%
$V_n$	Input Equivalent Noise Voltage $f = 1\text{ KHz}$ $R_S = 10\text{ }\Omega$		38			38		nV/ $\sqrt{\text{Hz}}$
$V_{O1}/V_{O2}$	Cross Talk Attenuation		120			120		dB

Note : 1. Low output voltage is less than 50mV.

**ELECTRICAL CHARACTERISTICS FOR TS27L4**

$T_{amb} = 25\text{ }^{\circ}\text{C}$ ,  $V_{CC} = 10\text{ V}$  (unless otherwise specified)

$R_L$  Connected to  $V_{CC}$

Symbol	Parameter	TS27L4C			TS27L4I/TS27L4M			Unit
		Min.	Typ.	Max.	Min.	Typ.	Max.	
$V_{io}$	Input Offset Voltage $V_o = 1.4\text{ V}$ TS27L4 $T_{min} < T < T_{max}$ TS27L4A $T_{min} < T < T_{max}$ TS27L4B $T_{min} < T < T_{max}$			10 12 5 6.5 2 3.5			10 12 5 6.5 2 3.5	mV
$\alpha V_{io}$	Temperature Coefficient of Input Voltage		0.7			0.7		$\mu\text{V}/^{\circ}\text{C}$
$I_{io}$	Input Offset Current $V_i = 5\text{ V}$ , $V_o = 5\text{ V}$ $T_{min} < T < T_{max}$		1	0.1		1	0.2	$\mu\text{A}$ nA
$I_b$	Input Bias Current $V_i = 5\text{ V}$ , $V_o = 5\text{ V}$ $T_{min} < T < T_{max}$		1	0.15		1	0.3	$\mu\text{A}$ nA
$V_{DH}$	High Output Voltage (note 1) $V_i = 10\text{ mV}$ $R_L = 1\text{ M}\Omega$ $T_{min} < T < T_{max}$	8.8 8.7	9		8.8 8.6	9		V
$A_{vd}$	Large Signal Voltage Gain $V_o = 1\text{ V to }6\text{ V}$ $R_L = 100\text{ k}\Omega$ $V_i = 5\text{ V}$ $T_{min} < T < T_{max}$	60 45	100		60 40	100		V/mV
$G_{BW}$	Gain Bandwidth Product $A_v = 40\text{ dB}$ $R_L = 1\text{ M}\Omega$ $C_L = 100\text{ pF}$ $f_{in} = 10\text{ KHz}$		0.1			0.1		MHz
CMR	Common Mode Rejection Ratio $V_o = 1.4\text{ V}$ $V_i = 1\text{ V to }7.4\text{ V}$	65	80		65	80		dB
SVR	Supply Voltage Rejection Ratio $V_{CC} = 5\text{ V to }10\text{ V}$ $V_o = 1.4\text{ V}$	60	80		60	80		dB
$I_{CC}$	Supply Current (per amplifier) $A_v = 1$ , no Load $V_o = 5\text{ V}$ $T_{min} < T < T_{max}$		10	15 17		10	15 18	$\mu\text{A}$
$I_s$	Output Current $V_i = 10\text{ mV}$ , $V_o = 0\text{ V}$	45	60	85	45	60	85	mA
$I_s$ (Sink)	Output Current $V_i = -10\text{ mV}$ , $V_o = V_{CC}$	35	45	65	35	45	65	mA
$S_{VO}$	Slew Rate at Unity Gain		0.04			0.04		V/ $\mu\text{S}$
$\phi_m$	Phase Margin at Unity Gain $A_v = 40\text{ dB}$ $R_L = 1\text{ M}\Omega$ $C_L = 100\text{ pF}$		45			45		Degrees
$K_{OV}$	Overshoot Factor		30			30		%
$V_n$	Input Equivalent Noise Voltage $f = 1\text{ KHz}$ $R_S = 10\text{ }\Omega$		70			70		nV/ $\sqrt{\text{Hz}}$
$V_{O1} / V_{O2}$	Cross Talk Attenuation		120			120		dB

Note : 1. Low output voltage is less than 50mV

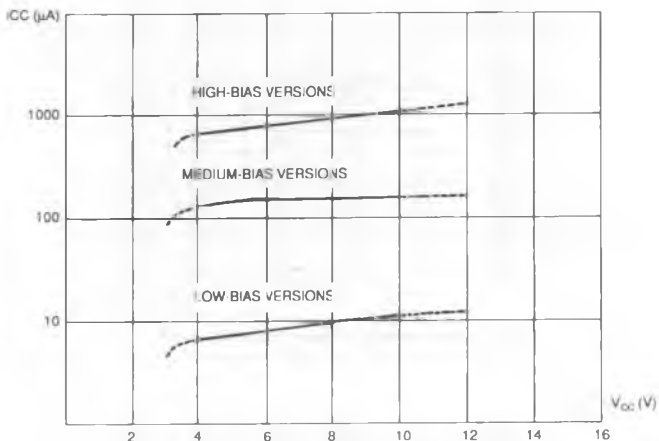

SUPPLY CURRENT vs FREE-AIR TEMPERATURE

$V_O = V_{IC} = 0.2 V_{CC}$ ,  $T_{amb} = 25\text{ }^\circ\text{C}$ , NO LOAD

E88TS274-02

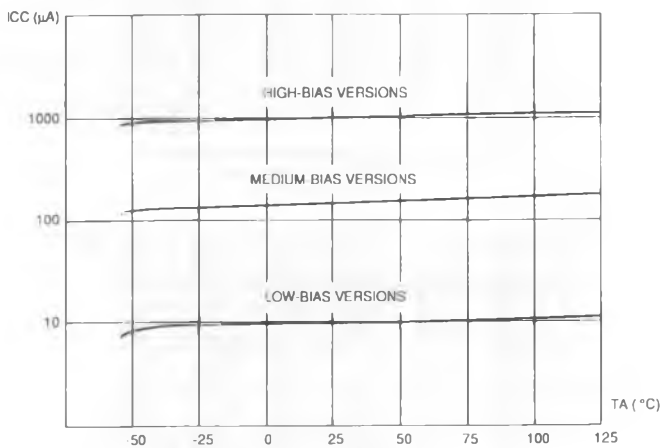

SUPPLY CURRENT vs FREE-AIR TEMPERATURE

$V_{CC} = 10\text{ V}$ ,  $V_{IC} = 5\text{ V}$ ,  $V_O = 5\text{ V}$ , NO LOAD

E88TS274-03

TS274

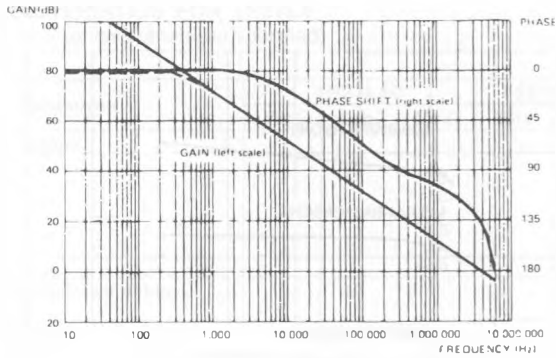

OPEN LOOP FREQUENCY RESPONSE AND PHASE SHIFT  
 $V_{CC} = 10V, R_L = 10k\Omega, C_L = 100pF, T_{amb} = 25^\circ C$

E88TS274-04

TS27M4

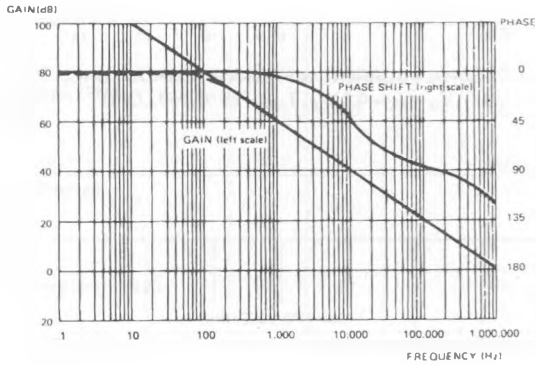

OPEN LOOP FREQUENCY RESPONSE AND PHASE SHIFT  
 $V_{CC} = 10V, R_L = 100k\Omega, C_L = 100pF, T_{amb} = 25^\circ C$

E88TS274-05

TS27L4

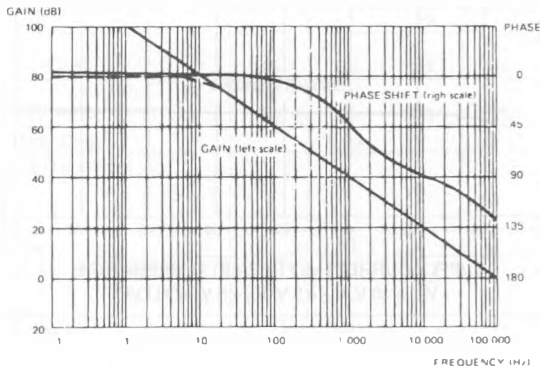

OPEN LOOP FREQUENCY RESPONSE AND PHASE SHIFT  
 $V_{CC} = 10V, R_L = 1M\Omega, C_L = 100pF, T_{amb} = 25^\circ C$

E88TS274-06



ORDER CODES

Part Number	Temperature Range °C	Package		
		N	D	J
TS274C	0 to + 70	•	•	
TS274AC	0 to + 70	•	•	
TS274BC	0 to + 70	•	•	
TS274I	- 40 to + 105	•	•	
TS274M	- 55 to + 125			•
TS27M4C	0 to + 70	•	•	
TS27M4AC	0 to + 70	•	•	
TS27M4BC	0 to + 70	•	•	
TS27M4I	- 40 to + 105	•	•	
TS27M4M	- 55 to + 125			•
TS27L4C	0 to + 70	•	•	
TS27L4AC	0 to + 70	•	•	
TS27L4BC	0 to + 70	•	•	
TS27M4I	- 40 to + 105	•	•	
TS27L4M	- 55 to + 125			•
TS27M4AI	- 40 to + 105	•	•	
TS27M4AM	- 55 to + 125			•
TS27M4BI	- 40 to + 105	•	•	
TS27M4BM	- 55 to + 125			•
TS27L4AI	- 40 to + 105	•	•	
TS27L4AM	- 55 to + 125			•
TS27L4BI	- 40 to + 105	•	•	
TS27L4BM	- 55 to ± 125			•

Examples : TS27L4ACN, TS274CD

PACKAGE MECHANICAL DATA

14 PINS - PLASTIC DIP OR CERDIP

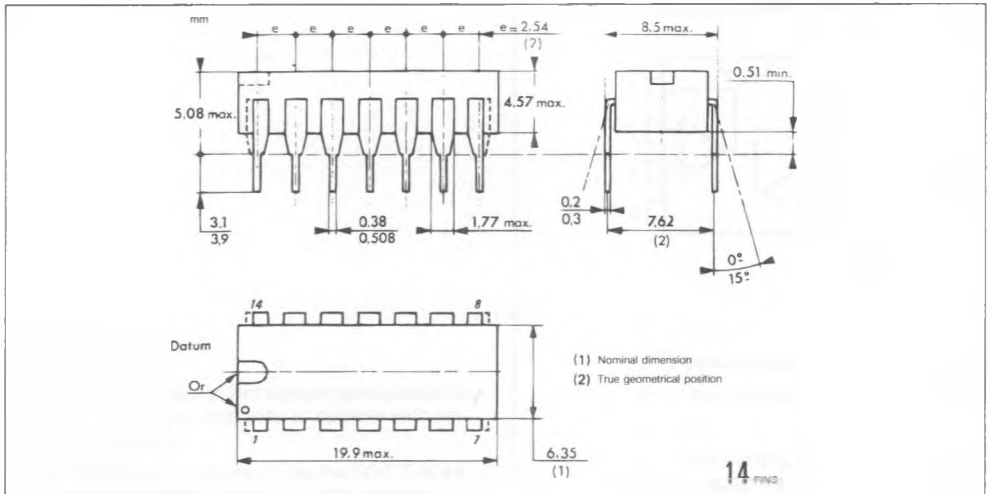

PACKAGE MECHANICAL DATA (continued)

14 PINS - PLASTIC MICROPACKAGE SO

