



SANYO Semiconductors

DATA SHEET

An ON Semiconductor Company

TND314S — ExPD (Excellent Power Device) General Purpose Driver for PDP Sustain Pulse Drive, Motor Drive, Switching Power Supply, and DC / DC Converter Applications

Features

- Dual inverter
- Withstand voltage of 25V is assured
- Peak output current : 1A
- Fully compatible input to TTL / CMOS (V_{IH} =up to 2.6V, at V_{DD} =4.5 to 25V)
- Built-in input pull-down resistance
- Monolithic structure (High voltage CMOS process adopted)
- Wide range of operating voltage : 4.5V to 25V
- Fast switching time (25ns typical at 1000pF load)
- Halogen free compliance

Specifications

Absolute Maximum Ratings at $T_a=25^\circ\text{C}$

Parameter	Symbol	Conditions	Ratings	Unit
Supply Voltage	V_{DD}		0 to 25	V
Input Voltage	V_{IN}		$GND-0.3$ to $V_{DD}+0.3$	V
Allowable Power Dissipation	P_D max		0.3	W
Junction Temperature	T_j		-55 to +150	$^\circ\text{C}$
Storage Temperature	T_{stg}		-55 to +150	$^\circ\text{C}$

Package Dimensions

unit : mm (typ)

7072-005

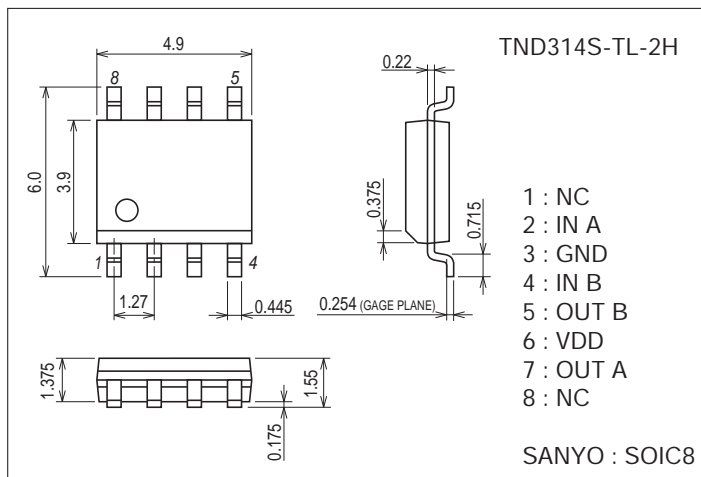

Product & Package Information

- Package : SOIC8
- JEITA, JEDEC : SC-87, SOT-96
- Minimum Packing Quantity : 2,500 pcs./reel

Packing Type: TL

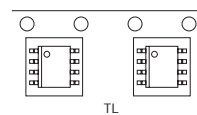

Marking

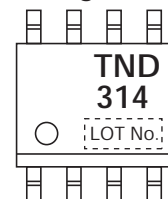

Block Diagram

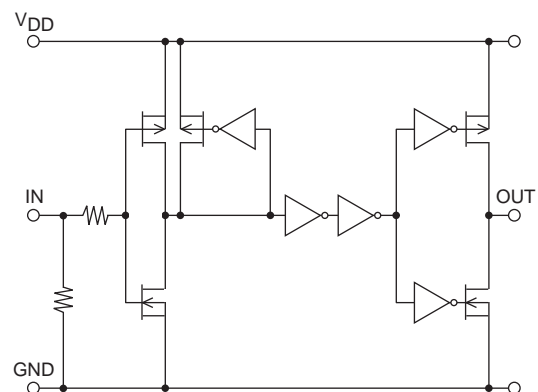

TND314S

Recommend Operating Conditions at Ta=25°C

Parameter	Symbol	Conditions	Ratings	Unit
Operating Supply Voltage	V _{DD}		4.5 to 25	V
Operating Temperature	Topr		-40 to +125	°C

Electrical Characteristics (AC Characteristics) at Ta=25°C, V_{DD}=18V, V_{IN}=5V

Parameter	Symbol	Conditions	Ratings			Unit
			min	typ	max	
Turn-On Rise Time	t _r	C _L =1000pF		30	45	ns
Turn-Off Fall Time	t _f	C _L =1000pF		30	45	ns
Delay Time	t _{D1}	C _L =1000pF		25	40	ns
	t _{D2}	C _L =1000pF		45	60	ns

Electrical Characteristics (DC Characteristics) at Ta=25°C, V_{DD}=4.5 to 25V

Parameter	Symbol	Conditions	Ratings			Unit
			min	typ	max	
Logic "1" Input Voltage	V _{IH}		2.6			V
Logic "0" Input Voltage	V _{IL}				0.8	V
Logic "1" Input Bias Current	I _{IN+}	V _{IN} =V _{DD} =25V		40	100	μA
Logic "0" Input Bias Current	I _{IN-}	V _{IN} =0V or V _{DD}	-1		1	μA
High-level Output Voltage	V _{OH}	I _O =0A	V _{DD} -0.1			V
Low-level Output Voltage	V _{OL}	I _O =0A			0.1	V
V _{DD} Supply Current	I _{supp}	V _{DD} =10V, V _{IN} =3V, (both inputs)		1.0	4.5	mA
		V _{DD} =10V, V _{IN} =0V, (both inputs)			0.2	mA
Output High Short Circuit Pulsed Current	I _{O+}	V _{DD} =18V, PW≤10μs, V _O UT=0V		1.0		A
Output Low Short Circuit Pulsed Current	I _{O-}	V _{DD} =18V, PW≤10μs, V _O UT=18V		1.0		A
Output On Resistance	R _{OUT}	V _{DD} =18V, I _{load} =10mA, V _O UT="H"		8	12	Ω
		V _{DD} =18V, I _{load} =10mA, V _O UT="L"		6	10	Ω

Switching Time Test Circuit

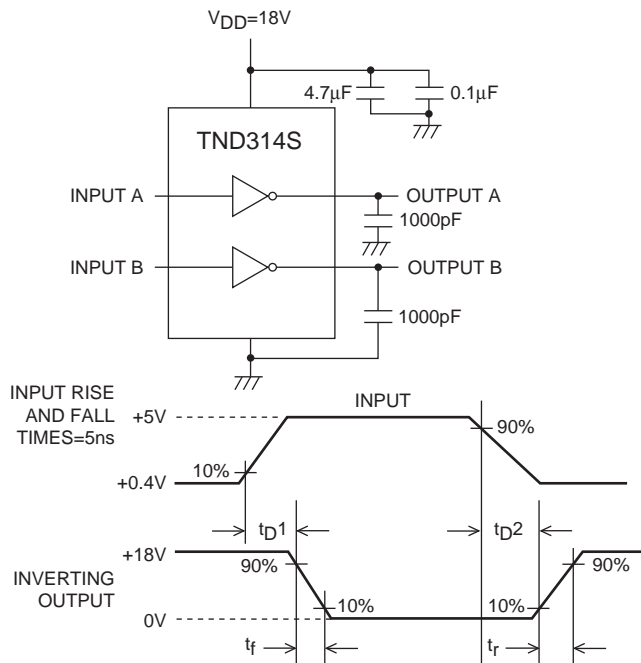

Ordering Information

Devices	Package	Shipping	memo
TND314S-TL-2H	SOIC8	2,500pcs./reel	Pb Free and Halogen Free

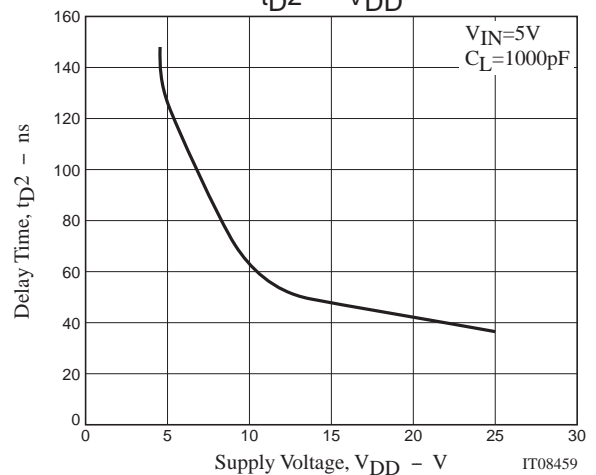
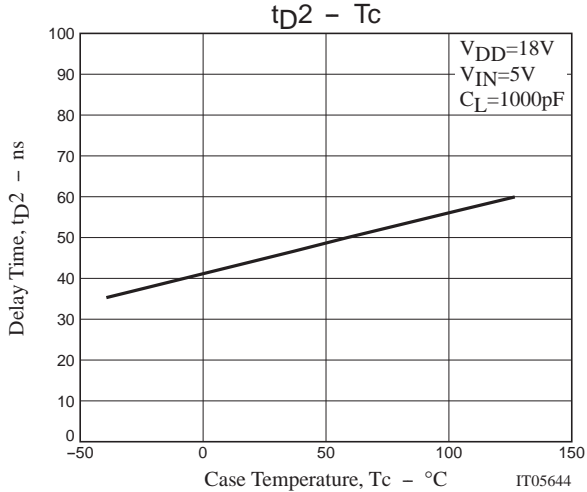
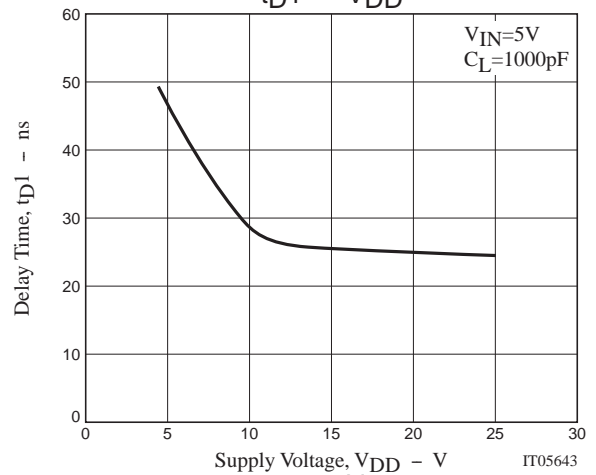
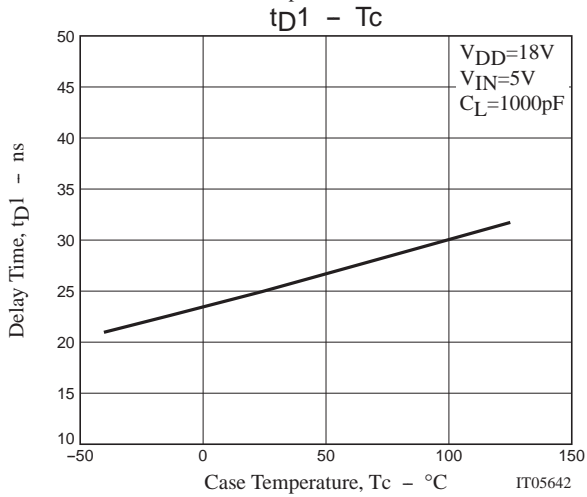
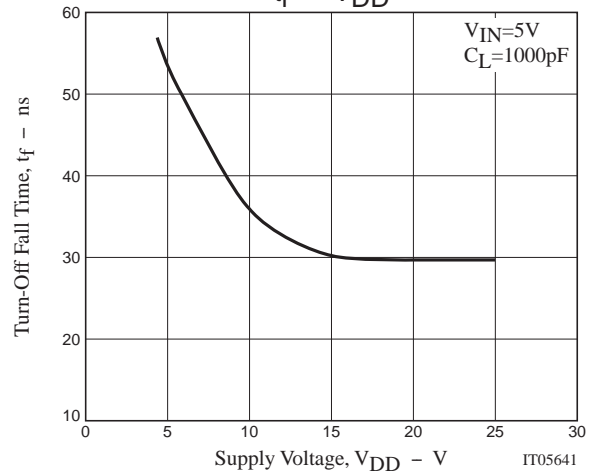
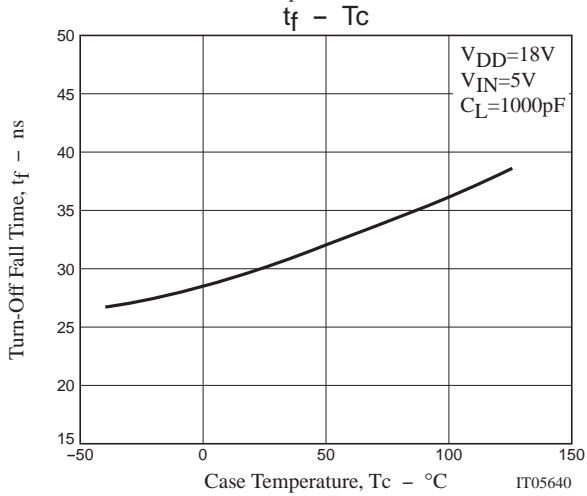
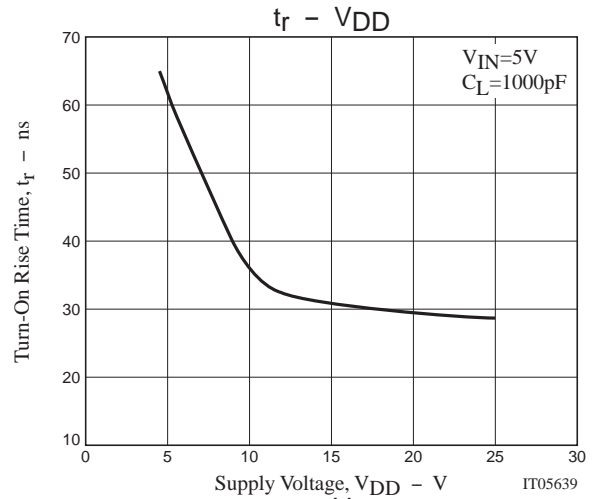
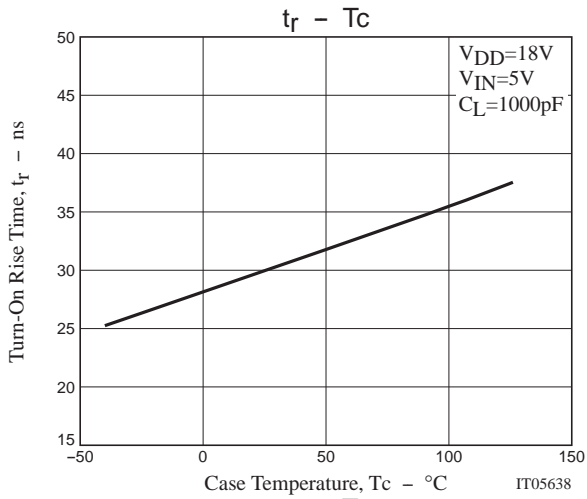

TND314S

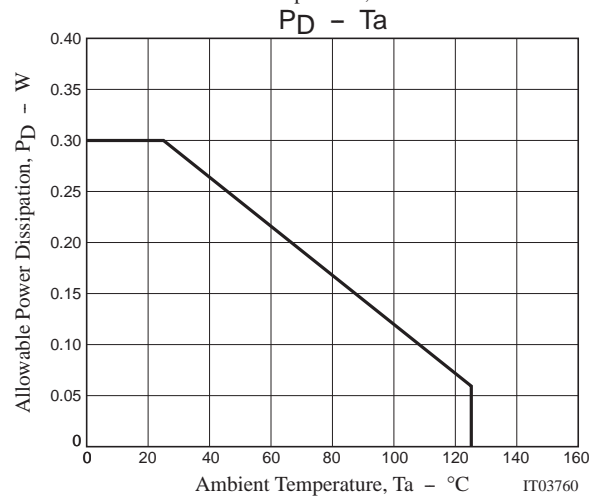
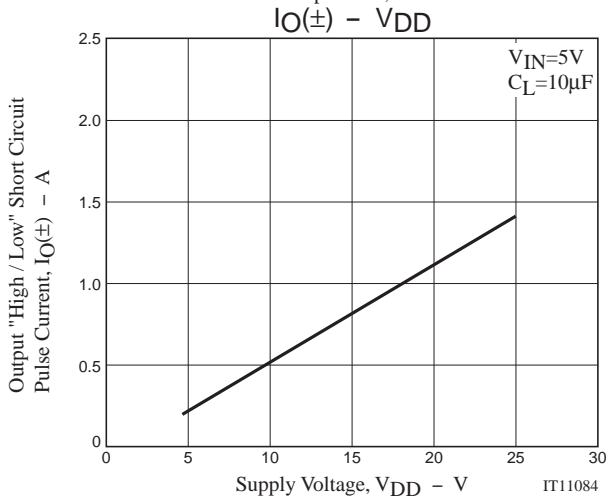
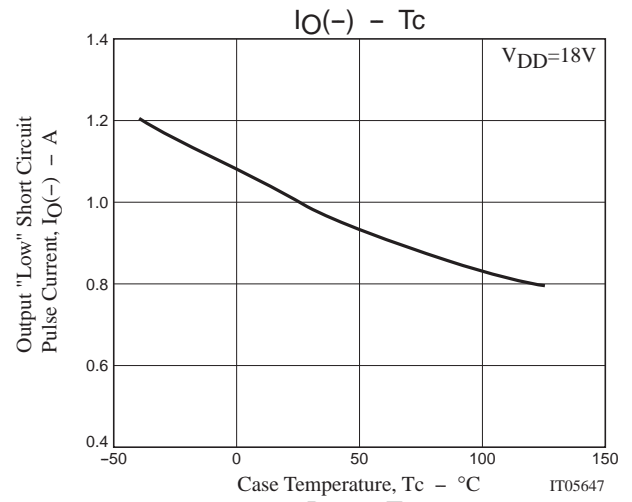
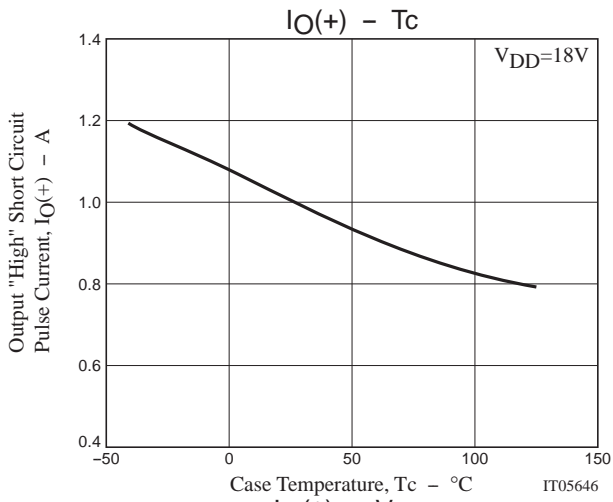

TND314S

Taping Specification

TND314S-TL-2H

1. Packing Format

Package Name	Carrier Tape Type	Maximum Number of devices contained (pcs)			Packing format	
		Reel	Inner box	Outer box	Inner BOX W206-112	Outer BOX W207-124
SOIC8	B202-101	2,500	12,500	25,000	5 reels contained Dimensions :mm(external) 340×95×340	2 inner boxes contained Dimensions :mm(external) 360×210×375

Packing method

Reel label, Inner box label (unit: mm)

Outer box label

It is a label at the time of factory shipments.
The form of a label may change in physical distribution process.

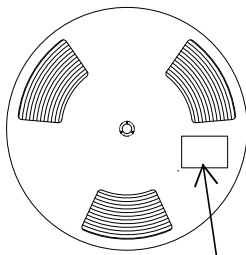

Type No. →
LOT No. →
Quantity →
Origin →

Reel label

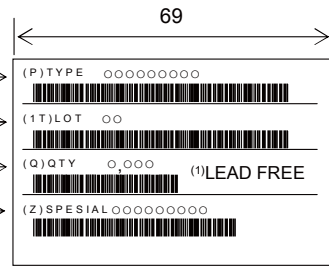

NOTE(1)

The LEAD FREE 4 description shows that it is complete lead free.

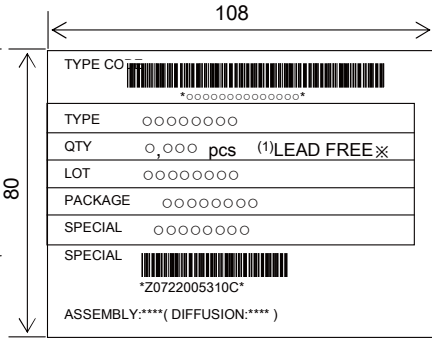

Label	JEITA Phase
LEAD FREE 4	JEITA Phase 3

2. Taping configuration

2-1. Carrier tape size (unit: mm)

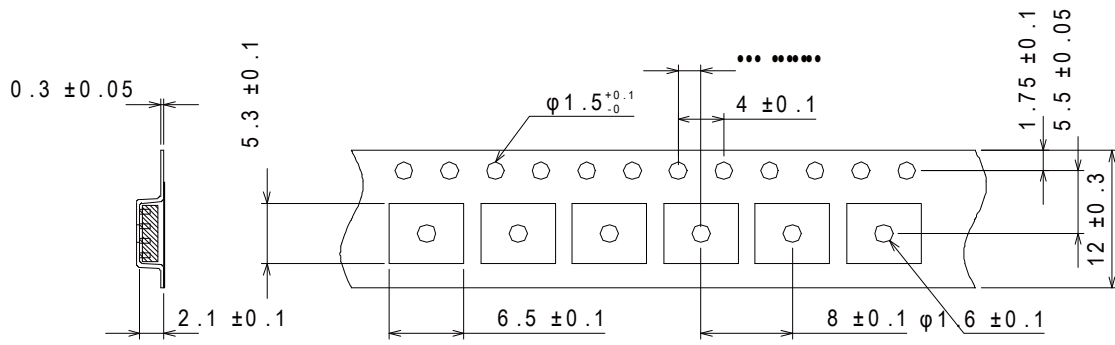

2-2. Device placement direction

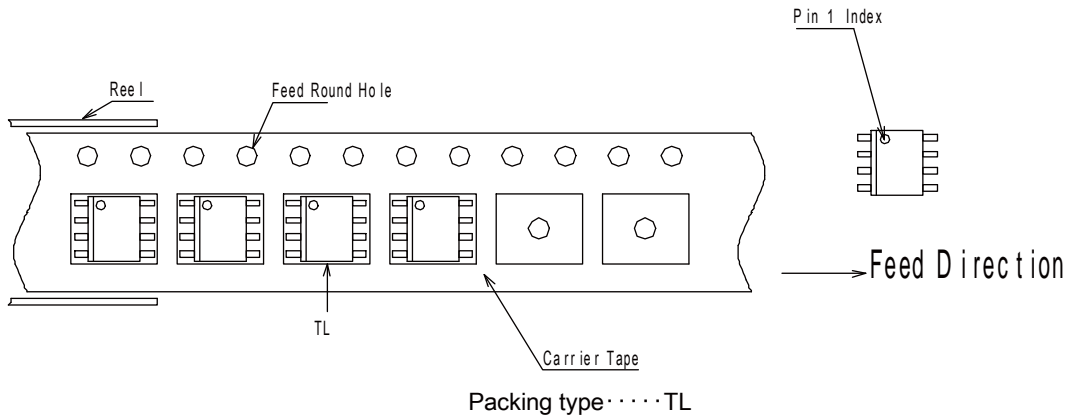

2-3. Leader portion and trailer portion (unit: mm)

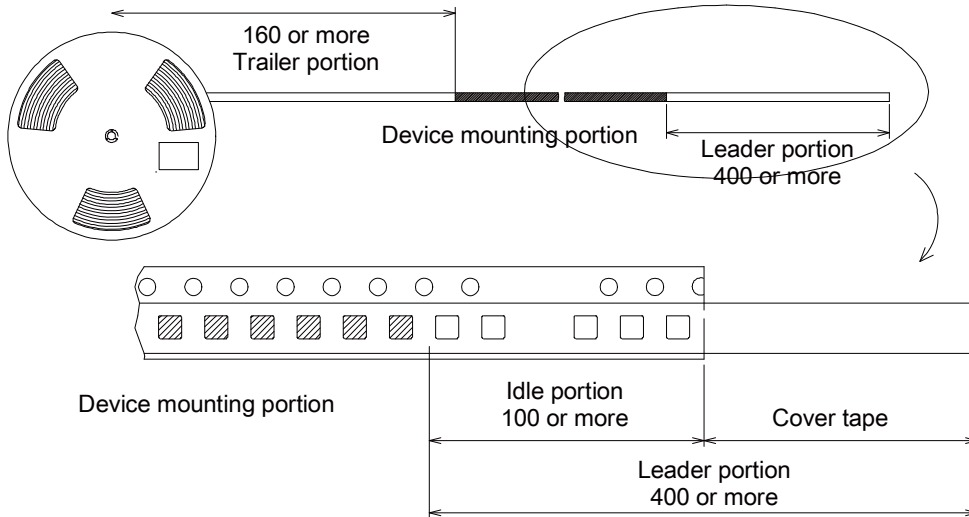

TND314S

Outline Drawing TND314S-TL-2H

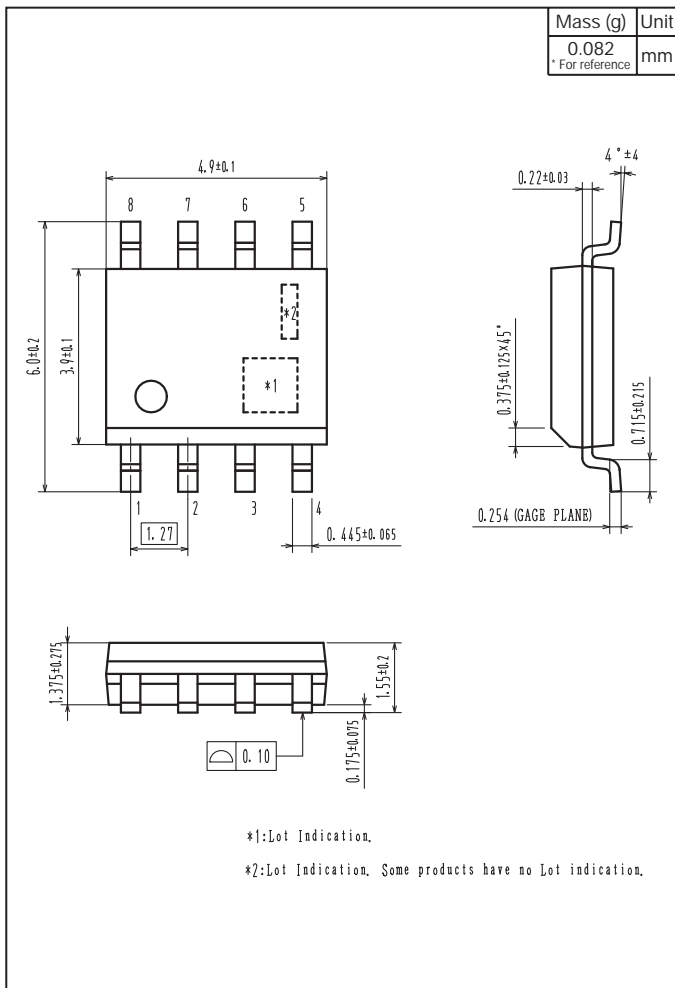

Land Pattern Example

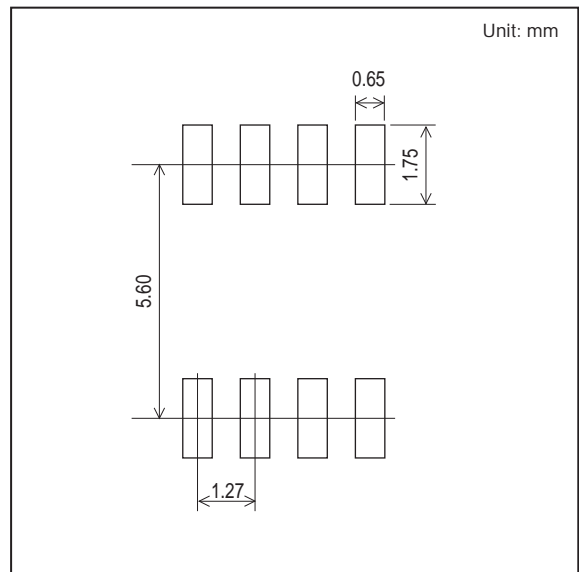

- Any and all SANYO Semiconductor Co.,Ltd. products described or contained herein are, with regard to "standard application", intended for the use as general electronics equipment. The products mentioned herein shall not be intended for use for any "special application" (medical equipment whose purpose is to sustain life, aerospace instrument, nuclear control device, burning appliances, transportation machine, traffic signal system, safety equipment etc.) that shall require extremely high level of reliability and can directly threaten human lives in case of failure or malfunction of the product or may cause harm to human bodies, nor shall they grant any guarantee thereof. If you should intend to use our products for new introduction or other application different from current conditions on the usage of automotive device, communication device, office equipment, industrial equipment etc. , please consult with us about usage condition (temperature, operation time etc.) prior to the intended use. If there is no consultation or inquiry before the intended use, our customer shall be solely responsible for the use.
- Specifications of any and all SANYO Semiconductor Co.,Ltd. products described or contained herein stipulate the performance, characteristics, and functions of the described products in the independent state, and are not guarantees of the performance, characteristics, and functions of the described products as mounted in the customer's products or equipment. To verify symptoms and states that cannot be evaluated in an independent device, the customer should always evaluate and test devices mounted in the customer's products or equipment.
- SANYO Semiconductor Co.,Ltd. assumes no responsibility for equipment failures that result from using products at values that exceed, even momentarily, rated values (such as maximum ratings, operating condition ranges, or other parameters) listed in products specifications of any and all SANYO Semiconductor Co.,Ltd. products described or contained herein.
- Regarding monolithic semiconductors, if you should intend to use this IC continuously under high temperature, high current, high voltage, or drastic temperature change, even if it is used within the range of absolute maximum ratings or operating conditions, there is a possibility of decrease reliability. Please contact us for a confirmation.
- SANYO Semiconductor Co.,Ltd. strives to supply high-quality high-reliability products, however, any and all semiconductor products fail or malfunction with some probability. It is possible that these probabilistic failures or malfunction could give rise to accidents or events that could endanger human lives, trouble that could give rise to smoke or fire, or accidents that could cause damage to other property. When designing equipment, adopt safety measures so that these kinds of accidents or events cannot occur. Such measures include but are not limited to protective circuits and error prevention circuits for safe design, redundant design, and structural design.
- In the event that any or all SANYO Semiconductor Co.,Ltd. products described or contained herein are controlled under any of applicable local export control laws and regulations, such products may require the export license from the authorities concerned in accordance with the above law.
- No part of this publication may be reproduced or transmitted in any form or by any means, electronic or mechanical, including photocopying and recording, or any information storage or retrieval system, or otherwise, without the prior written consent of SANYO Semiconductor Co.,Ltd.
- Any and all information described or contained herein are subject to change without notice due to product/technology improvement, etc. When designing equipment, refer to the "Delivery Specification" for the SANYO Semiconductor Co.,Ltd. product that you intend to use.
- Upon using the technical information or products described herein, neither warranty nor license shall be granted with regard to intellectual property rights or any other rights of SANYO Semiconductor Co.,Ltd. or any third party. SANYO Semiconductor Co.,Ltd. shall not be liable for any claim or suits with regard to a third party's intellectual property rights which has resulted from the use of the technical information and products mentioned above.

This catalog provides information as of September, 2012. Specifications and information herein are subject to change without notice.