

## TMP23x Low-Power, High-Accuracy Analog Output Temperature Sensors

### 1 Features

- Cost-Effective Alternative to Thermistors
- Wide Temperature Measurement Range:
  - $-40^{\circ}\text{C}$  to  $+150^{\circ}\text{C}$  (TMP235)
  - $-10^{\circ}\text{C}$  to  $+125^{\circ}\text{C}$  (TMP236)
- Available in Two Accuracy Level Variants:
  - A2 Level:  $\pm 0.5^{\circ}\text{C}$  (Typical)
  - A4 Level:  $\pm 1^{\circ}\text{C}$  (Typical)
- Positive Slope Sensor Gain, Offset (Typical):
  - $10\text{ mV}/^{\circ}\text{C}$ ,  $500\text{ mV}$  at  $0^{\circ}\text{C}$  (TMP235)
  - $19.5\text{ mV}/^{\circ}\text{C}$ ,  $400\text{ mV}$  at  $0^{\circ}\text{C}$  (TMP236)
- Wide Operating Supply Voltage Range:
  - $2.3\text{ V}$  to  $5.5\text{ V}$  (TMP235)
  - $3.1\text{ V}$  to  $5.5\text{ V}$  (TMP236)
- Short Circuit Protected Output
- Low Power:  $9\text{ }\mu\text{A}$  (Typical)
- Strong Output For Driving Loads up to  $1000\text{ pF}$
- Available Package Options:
  - 5-Pin SC70 (DCK) Surface Mount
  - 3-Pin SOT-23 (DBZ) Surface Mount

### 2 Applications

- Grid Infrastructure
- Wireless and Telecom Infrastructure
- Automotive Infotainment
- Factory Automation and Control
- Test and Measurement

### 3 Description

The TMP23x devices are a family of precision CMOS integrated-circuit linear analog temperature sensors with an output voltage proportional to temperature engineers can use in multiple analog temperature-sensing applications. These temperature sensors are more accurate than similar pin-compatible devices on the market, featuring typical accuracy from  $0^{\circ}\text{C}$  to  $+70^{\circ}\text{C}$  of  $\pm 0.5^{\circ}\text{C}$  and  $\pm 1^{\circ}\text{C}$ . The increased accuracy of the series is designed for many analog temperature-sensing applications. The TMP235 device provides a positive slope output of  $10\text{ mV}/^{\circ}\text{C}$  over the full  $-40^{\circ}\text{C}$  to  $+150^{\circ}\text{C}$  temperature range and a supply range from  $2.3\text{ V}$  to  $5.5\text{ V}$ . The higher gain TMP236 sensor provides a positive slope output of  $19.5\text{ mV}/^{\circ}\text{C}$  from  $-10^{\circ}\text{C}$  to  $+125^{\circ}\text{C}$  and a supply range from  $3.1\text{ V}$  to  $5.5\text{ V}$ .

The  $9\text{-}\mu\text{A}$  typical quiescent current and  $800\text{-}\mu\text{s}$  typical power-on time enable effective power-cycling architectures to minimize power consumption for battery-powered devices. A class-AB output driver provides a strong  $500\text{-}\mu\text{A}$  maximum output to drive capacitive loads up to  $1000\text{ pF}$  and is designed to directly interface to analog-to-digital converter sample and hold inputs. With excellent accuracy and a strong linear output driver, the TMP23x analog output temperature sensors are cost-effective alternatives to passive thermistors.

#### Device Information<sup>(1)</sup>

PART NUMBER	PACKAGE	BODY SIZE (NOM)
TMP235, TMP236	SC70 (5)	$2.00\text{ mm} \times 1.25\text{ mm}$
	SOT-23 (3) <sup>(2)</sup>	$2.92\text{ mm} \times 1.30\text{ mm}$

(1) For all available packages, see the orderable addendum at the end of the data sheet.

(2) Package for preview only.

#### Functional Block Diagram

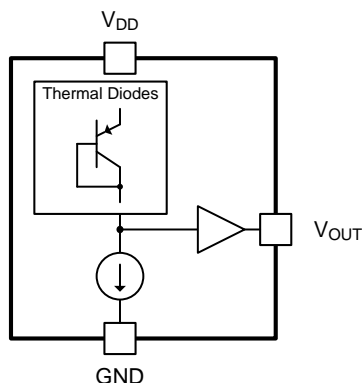

#### Output Voltage vs Ambient

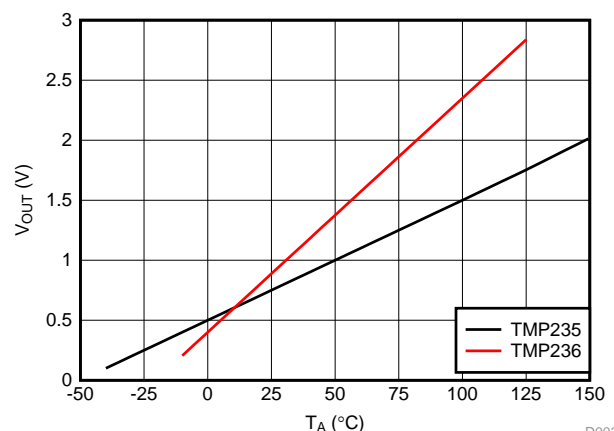

D003



## Table of Contents

<b>1 Features</b> .....	<b>1</b>	7.4 Device Functional Modes.....	<b>10</b>
<b>2 Applications</b> .....	<b>1</b>	<b>8 Application and Implementation</b> .....	<b>11</b>
<b>3 Description</b> .....	<b>1</b>	8.1 Application Information.....	<b>11</b>
<b>4 Revision History</b> .....	<b>2</b>	8.2 Typical Application .....	<b>11</b>
<b>5 Pin Configuration and Functions</b> .....	<b>3</b>	<b>9 Power Supply Recommendations</b> .....	<b>12</b>
<b>6 Specifications</b> .....	<b>4</b>	<b>10 Layout</b> .....	<b>12</b>
6.1 Absolute Maximum Ratings .....	4	10.1 Layout Guidelines .....	12
6.2 ESD Ratings.....	4	10.2 Layout Examples.....	12
6.3 Recommended Operating Conditions.....	4	<b>11 Device and Documentation Support</b> .....	<b>13</b>
6.4 Thermal Information .....	4	11.1 Related Links .....	13
6.5 Electrical Characteristics.....	5	11.2 Receiving Notification of Documentation Updates	13
6.6 Typical Characteristics .....	6	11.3 Community Resources.....	13
<b>7 Detailed Description</b> .....	<b>8</b>	11.4 Trademarks .....	13
7.1 Overview .....	8	11.5 Electrostatic Discharge Caution.....	13
7.2 Functional Block Diagram .....	8	11.6 Glossary .....	13
7.3 Feature Description.....	8	<b>12 Mechanical, Packaging, and Orderable Information</b> .....	<b>13</b>

## 4 Revision History

NOTE: Page numbers for previous revisions may differ from page numbers in the current version.

<b>Changes from Revision B (February 2018) to Revision C</b>	<b>Page</b>
• Added DBZ (SOT-23) preview package .....	1
• Added TMP236 test conditions to the operating current parameters.....	5
• Added SOT-23 and SC70 package test conditions to the Accuracy Level 2 (A2) limits in the 0°C to 70°C range.....	5

<b>Changes from Revision A (December 2017) to Revision B</b>	<b>Page</b>
• Changed reference to typical accuracy specifications from: $\pm 1^\circ\text{C}$ and $\pm 2^\circ\text{C}$ to: $\pm 0.5^\circ\text{C}$ and $\pm 1^\circ\text{C}$ .....	1
• Deleted erroneous AOQL footnote .....	5
• Changed specification limits indicated in <a href="#">Figure 1</a> .....	6
• Added <i>Device Functional Modes</i> section .....	10

<b>Changes from Original (September 2017) to Revision A</b>	<b>Page</b>
• Changed document status from Advance Information to Production Data .....	1

## 5 Pin Configuration and Functions

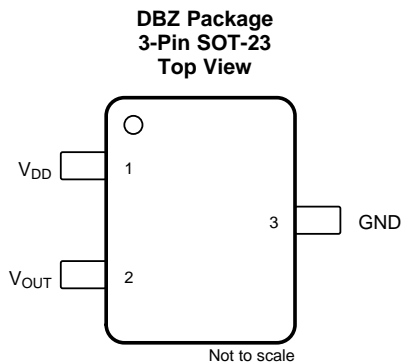

(1) DBZ package for preview only.

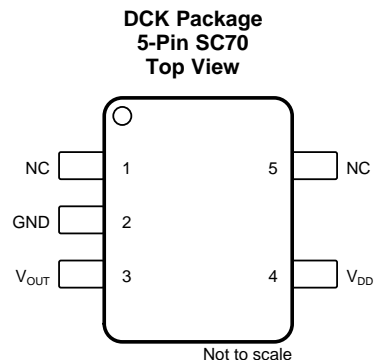

NC- no internal connection

### Pin Functions

NAME	PIN		TYPE	DESCRIPTION
	SOT-23	SC70		
GND	3	2	Ground	Power supply ground
NC	—	5	—	No internal connection. This pin may be left floating or connected to GND.
NC	—	1	—	No internal connection. This pin may be left floating or connected to GND.
V <sub>OUT</sub>	2	3	O	Outputs voltage proportional to temperature
V <sub>DD</sub>	1	4	I	Positive supply input

## 6 Specifications

### 6.1 Absolute Maximum Ratings

over operating free-air temperature range (unless otherwise noted) <sup>(1)</sup>

	MIN	MAX	UNIT
Supply voltage, $V_{DD}$		+6	V
Output voltage, $V_{OUT}$	-0.3	( $V_{DD} + 0.3$ )	
Output current	-30	+30	mA
Latch-up current, each pin	-200	+200	
Junction temperature ( $T_J$ )		+150	°C
Storage temperature ( $T_{stg}$ )	-65	+150	

- (1) Stresses beyond those listed under *Absolute Maximum Ratings* may cause permanent damage to the device. These stress ratings only, which do not imply functional operation of the device at these or any other conditions beyond those indicated under *Recommended Operating Conditions*. Exposure to absolute-maximum-rated conditions for extended periods may affect device reliability.

### 6.2 ESD Ratings

		VALUE	UNIT
$V_{(ESD)}$ Electrostatic discharge	Human-body model (HBM) per JESD22-A114 <sup>(1)</sup>	±4000	V
	Charged-device model (CDM), per JEDEC specification JESD22-C101 <sup>(2)</sup>	±1000	

- (1) JEDEC document JEP155 states that 500-V HBM allows safe manufacturing with a standard ESD control process.  
 (2) JEDEC document JEP157 states that 250-V CDM allows safe manufacturing with a standard ESD control process.

### 6.3 Recommended Operating Conditions

over operating free-air temperature range (unless otherwise noted)

	MIN	NOM	MAX	UNIT
$V_{DD}$	Input voltage (TMP235)	2.3	5.5	V
	Input voltage (TMP236)	3.1	5.5	
$T_A$	Operating free-air temperature	-50	150	°C

### 6.4 Thermal Information

THERMAL METRIC <sup>(1)</sup> <sup>(2)</sup>	TMP235		UNIT
	DCK (SC70)	DBZ (SOT-23)	
	PINS	PINS	
$R_{\theta JA}$ Junction-to-ambient thermal resistance <sup>(3)</sup> <sup>(4)</sup>	275	167	°C/W
$R_{\theta JC(top)}$ Junction-to-case (top) thermal resistance	84	90	°C/W
$R_{\theta JB}$ Junction-to-board thermal resistance	56	146	°C/W
$\Psi_{JT}$ Junction-to-top characterization parameter	1.2	35	°C/W
$\Psi_{JB}$ Junction-to-board characterization parameter	55	146	°C/W

- (1) For more information about traditional and new thermal metrics, see the [Semiconductor and IC Package Thermal Metrics](#) application report.  
 (2) For information on self-heating and thermal response time see [Layout Guidelines](#) section.  
 (3) The junction to ambient thermal resistance ( $R_{\theta JA}$ ) under natural convection is obtained in a simulation on a JEDEC-standard, High-K board as specified in JESD51-7, in an environment described in JESD51-2. Exposed pad packages assume that thermal vias are included in the PCB, per JESD 51-5.  
 (4) Changes in output due to self heating can be computed by multiplying the internal dissipation by the thermal resistance.

## 6.5 Electrical Characteristics

TMP235:  $V_{DD} = 2.3\text{ V to }5.5\text{ V}$ , GND = Ground,  $T_A = -40^\circ\text{C to }+125^\circ\text{C}$  and no load (unless otherwise noted)

TMP236:  $V_{DD} = 3.1\text{ V to }5.5\text{ V}$ , GND = Ground,  $T_A = -10^\circ\text{C to }+125^\circ\text{C}$  and no load (unless otherwise noted)

PARAMETER		TEST CONDITIONS	MIN	TYP	MAX	UNIT	
<b>POWER SUPPLY</b>							
$I_{DD}$	Operating current	$T_A = 25^\circ\text{C}$ , $V_{DD} = 2.3\text{ V}$ , TMP235		9		$\mu\text{A}$	
		$T_A = 25^\circ\text{C}$ , $V_{DD} = 3.1\text{ V}$ , TMP236		10			
		$T_A = -40^\circ\text{C to }+125^\circ\text{C}$ , TMP235			14.5		
		$T_A = -10^\circ\text{C to }+125^\circ\text{C}$ , TMP236					15
		$T_A = 150^\circ\text{C}$ , TMP235					17
$\frac{\Delta^\circ\text{C}}{\Delta V_{DD}}$	Line regulation		-0.1	0.02	0.1	$^\circ\text{C/V}$	
<b>SENSOR ACCURACY</b>							
$T_{ACY}$	Temperature accuracy <sup>(1)</sup>	Accuracy Level 2 (A2)	$T_A = 25^\circ\text{C}$		$\pm 0.5$		$^\circ\text{C}$
			$T_A = 0^\circ\text{C to }70^\circ\text{C}$ (SC70 Package)	-1	$\pm 0.5$	+1	
			$T_A = 0^\circ\text{C to }70^\circ\text{C}$ (SOT-23 Package)	-1.2	$\pm 0.5$	+1.2	
			$T_A = -40^\circ\text{C to }+125^\circ\text{C}$ (TMP235A2)	-2	$\pm 0.5$	+2	
			$T_A = -10^\circ\text{C to }+125^\circ\text{C}$ (TMP236A2)	-2	$\pm 0.5$	+2	
		Accuracy Level 4 (A4)	$T_A = -40^\circ\text{C to }+150^\circ\text{C}$ (TMP235A2)	-2	$\pm 0.5$	+2	
			$T_A = 25^\circ\text{C}$		$\pm 1$		
			$T_A = 0^\circ\text{C to }70^\circ\text{C}$	-2	$\pm 1$	+2	
			$T_A = -40^\circ\text{C to }+125^\circ\text{C}$ (TMP235A4)	-4	$\pm 1$	+4	
			$T_A = -10^\circ\text{C to }+125^\circ\text{C}$ (TMP236A4)	-4	$\pm 1$	+4	
$T_A = -40^\circ\text{C to }+150^\circ\text{C}$ (TMP235A4)	-5	$\pm 1$	+5				
<b>SENSOR OUTPUT</b>							
$V_{0^\circ\text{C}}$	Output voltage offset at $0^\circ\text{C}$	TMP235		500		$\text{mV}$	
		TMP236		400			
$T_C$	Temperature coefficient (sensor gain)	TMP235		10		$\text{mV}/^\circ\text{C}$	
		TMP236		19.5			
$V_{ONL}$	Output nonlinearity <sup>(1)</sup>	$T_A = 0^\circ\text{C to }70^\circ\text{C}$ , no load		$\pm 0.5$		$^\circ\text{C}$	
$I_{OUT}$	Output current				500	$\mu\text{A}$	
$Z_{OUT}$	Output impedance	$I_{OUT} = 100\ \mu\text{A}$ , $f = 100\text{ Hz}$		20		$\Omega$	
		$I_{OUT} = 100\ \mu\text{A}$ , $f = 500\text{ Hz}$		50			
	Output load regulation	$T_A = 0^\circ\text{C to }70^\circ\text{C}$ , $I_{OUT} = 100\ \mu\text{A}$ , $\frac{\Delta V_{OUT}}{\Delta I_{OUT}}$		1		$\Omega$	
$t_{ON}$	Turn on time	Time to reach accuracy within $\pm 0.5^\circ\text{C}$		800		$\mu\text{s}$	
$C_{LOAD}$	Typical load capacitance				1000	$\text{pF}$	
$t_{RES}$	Thermal response to 63%	SC70	$30^\circ\text{C}$ (Air) to $+125^\circ\text{C}$ (Fluid Bath)		1.3	$\text{s}$	

- (1) Accuracy is defined as the error between the measured and reference output voltages, tabulated in the [TMP235 Transfer Table](#) and [TMP236 Transfer Table](#) at the specified conditions of supply voltage and temperature (expressed in  $^\circ\text{C}$ ). Accuracy limits include line regulation within the specified conditions. Accuracy limits do not include load regulation; they assume no DC load.

# TMP235, TMP236

SBOS857C – SEPTEMBER 2017 – REVISED AUGUST 2018

www.ti.com

## 6.6 Typical Characteristics

at  $T_A = 25^\circ\text{C}$ , (unless otherwise noted)

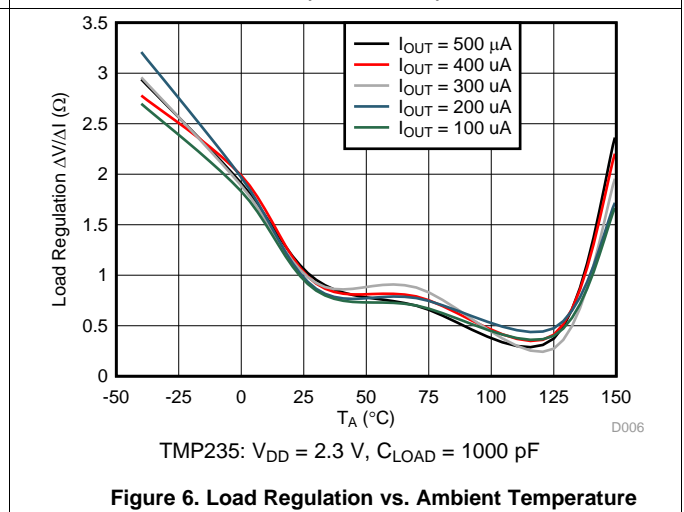
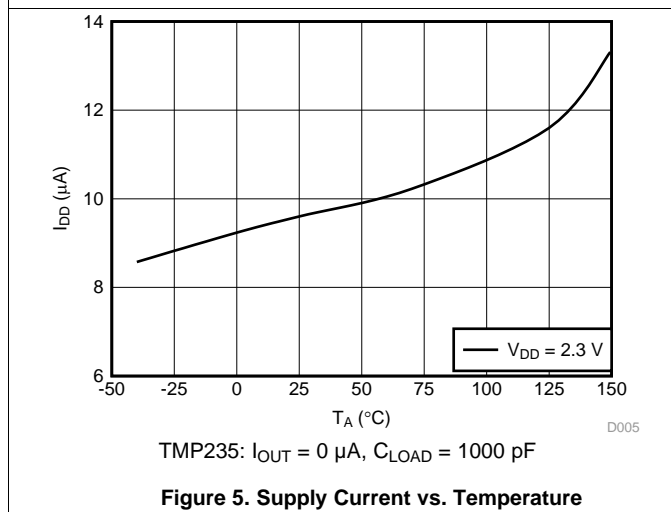
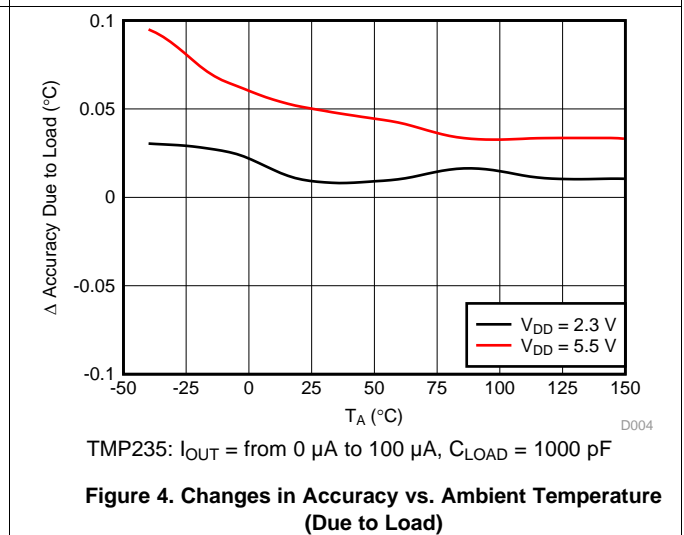
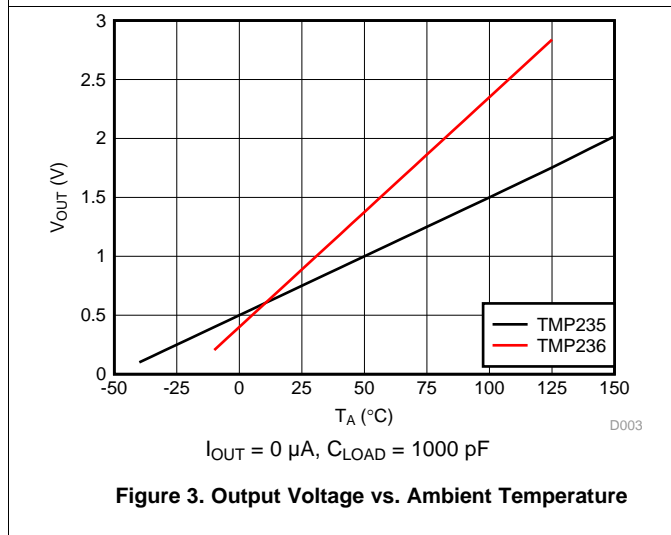
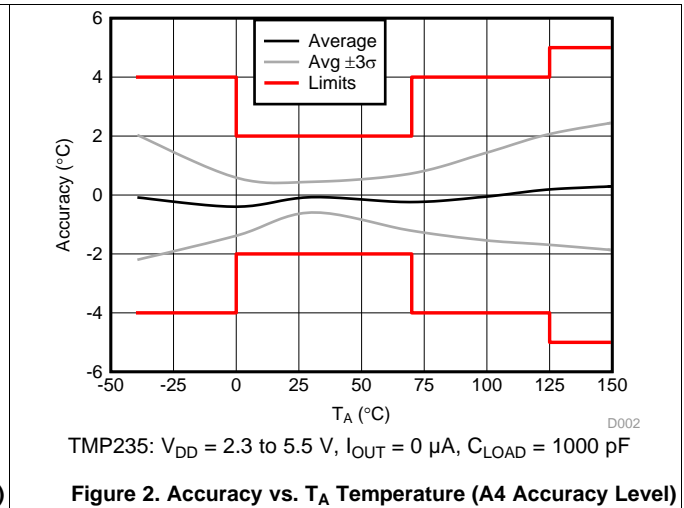
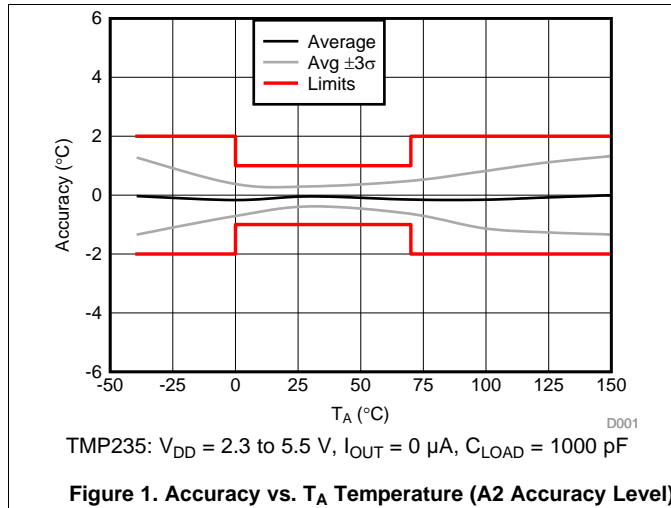

**Typical Characteristics (continued)**

at  $T_A = 25^\circ\text{C}$ , (unless otherwise noted)

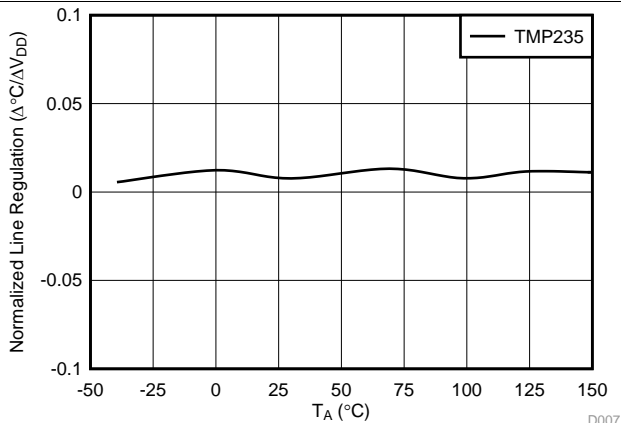

TMP235:  $V_{DD} = 2.3$  to  $5.5$  V,  $I_{OUT} = 0$   $\mu\text{A}$ ,  $C_{LOAD} = 1000$  pF

**Figure 7. Line Regulation ( $\Delta^\circ\text{C} / \Delta V_{DD}$ ) vs. Ambient Temperature**

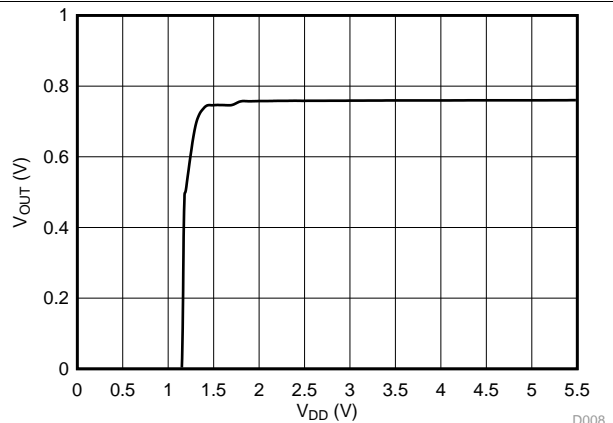

TMP235:  $T_A = 25^\circ\text{C}$

**Figure 8. Output Voltage vs. Power Supply**

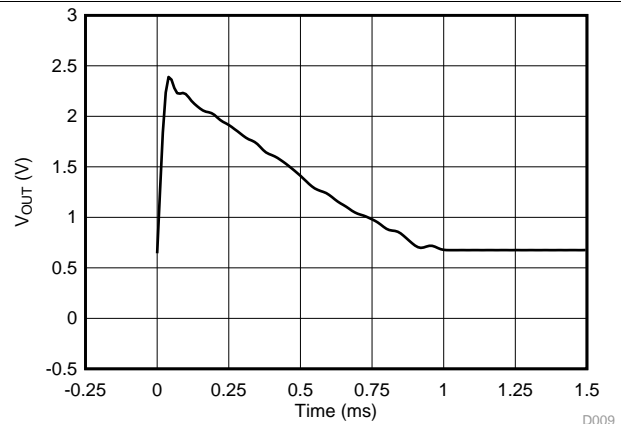

TMP235:  $T_A = 25^\circ\text{C}$

**Figure 9. Output vs. Settling Time to Step  $V_{DD}$**

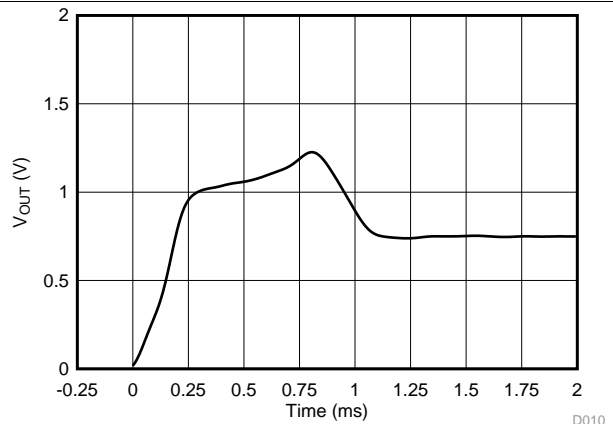

TMP235:  $T_A = 25^\circ\text{C}$ ,  $V_{DD}$  Ramp Rate =  $5$  V/ms

**Figure 10. Output vs. Settling Time to Ramp  $V_{DD}$**

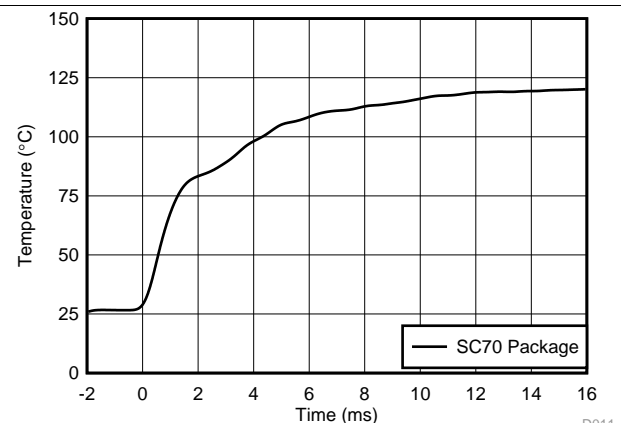

TMP235:  $1 \times 1$  (inches) PCB, Air  $26^\circ\text{C}$  to Fluid Bath  $123^\circ\text{C}$

**Figure 11. Thermal Response (Air-to-Fluid Bath)**

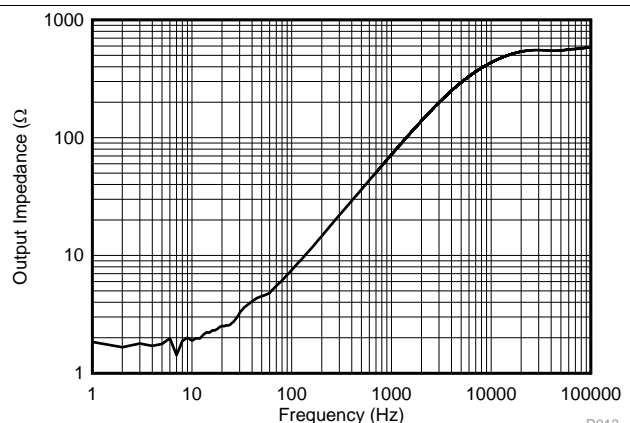

TMP235:  $T_A = 25^\circ\text{C}$ ,  $V_{DD} = 5$  V,  $I_{OUT} = 100$   $\mu\text{A}$

**Figure 12. Output Impedance vs. Frequency**

## 7 Detailed Description

### 7.1 Overview

The TMP23x devices are a family of linear analog temperature sensors with a output voltage proportional to temperature. These temperature sensors have an accuracy from 0°C to 70°C of ±1.25°C (TMP23xA2) and ±2°C (TMP23xA4). The TMP235 device provides a positive slope output of 10 mV/°C over the full –40°C to +150°C temperature range and a supply range from 2.3 V to 5.5 V. The higher gain TMP236 sensor provides a positive slope output of 19.5 mV/°C from –10°C to +125°C and a supply range from 3.1 V to 5.5 V. A class-AB output driver provides a maximum output of 500 µA to drive capacitive loads up to 1000 pF.

### 7.2 Functional Block Diagram

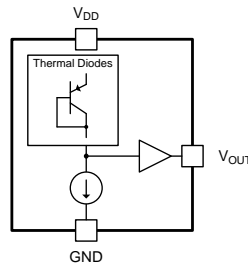

### 7.3 Feature Description

As shown in [Figure 3](#), the TMP23x devices are linear; however, a small  $V_{OUT}$  gain shift is present at temperatures above 100°C. When small shifts are expected, a piecewise linear function provides the best accuracy and is used for the device accuracy specifications (see [Specifications](#)). Typical output voltages of the TMP23x devices across the full operating temperature range are listed in [Table 3](#) and [Table 4](#). The ideal linear columns represent the ideal linear  $V_{OUT}$  output response with respect to temperature while the piecewise linear columns indicate the small voltage shift at elevated temperatures.

The piecewise linear function uses three temperature ranges listed in [Table 1](#) and [Table 2](#). In equation form, the voltage output  $V_{OUT}$  of the TMP23x is calculated by [Equation 1](#):

$$V_{OUT} = (T_A - T_{INFL}) \times T_C + V_{OFFS}$$

where

- $V_{OUT}$  is the TMP23x voltage output for a given temperature
  - $T_A$  is the ambient temperature in °C
  - $T_{INFL}$  is the temperature inflection point for a piecewise segment in °C
  - $T_C$  is the TMP23x temperature coefficient or gain
  - $V_{OFFS}$  is the TMP23x voltage offset
- (1)

Therefore, the  $T_A$  temperature for a given  $V_{OUT}$  voltage output within a piecewise voltage range ( $V_{RANGE}$ ) is calculated using [Equation 2](#). For applications where the accuracy enhancement above 100°C is not required, use the first row of [Table 1](#) and [Table 2](#) for all voltages.

$$T_A = (V_{OUT} - V_{OFFS}) / T_C + T_{INFL}$$

(2)

**Table 1. TMP235 Piecewise Linear Function Summary**

$T_A$ RANGE (°C)	$V_{RANGE}$ (mV)	$T_{INFL}$ (°C)	$T_C$ (mV/°C)	$V_{OFFS}$ (mV)
–40 to +100	< 1500	0	10	500
100 to 125	1500 to 1752.5	100	10.1	1500
125 to 150	> 1752.5	125	10.6	1752.5



**Table 2. TMP236 Piecewise Linear Function Summary**

T <sub>A</sub> RANGE (°C)	V <sub>RANGE</sub> (mV)	T <sub>INFL</sub> (°C)	T <sub>C</sub> (mV/°C)	V <sub>OFFS</sub> (mV)
–40 to +100	≤ 2350	0	19.5	400
100 to 125	> 2350	100	19.7	2350
125 to 150	—	—	—	—

**Table 3. TMP235 Transfer Table**

TEMPERATURE (°C)	V <sub>OUT</sub> (mV) IDEAL LINEAR VALUES	V <sub>OUT</sub> (mV) PIECEWISE LINEAR VALUES
–40	100	100
–35	150	150
–30	200	200
–25	250	250
–20	300	300
–15	350	350
–10	400	400
–5	450	450
0	500	500
5	550	550
10	600	600
15	650	650
20	700	700
25	750	750
30	800	800
35	850	850
40	900	900
45	950	950
50	1000	1000
55	1050	1050
60	1100	1100
65	1150	1150
70	1200	1200
75	1250	1250
80	1300	1300
85	1350	1350
90	1400	1400
95	1450	1450
100	1500	1500
105	1550	1550.5
110	1600	1601
115	1650	1651.5
120	1700	1702
125	1750	1752.5
130	1800	1805.5
135	1850	1858.5
140	1900	1911.5
145	1950	1964.5
150	2000	2017.5

**Table 4. TMP236 Transfer Table**

TEMPERATURE (°C)	V <sub>OUT</sub> (mV) IDEAL LINEAR VALUES	V <sub>OUT</sub> (mV) PIECEWISE LINEAR VALUES
-40	—	—
-35	—	—
-30	—	—
-25	—	—
-20	—	—
-15	—	—
-10	205	205
-5	303	303
0	400	400
5	498	498
10	595	595
15	693	693
20	790	790
25	888	888
30	985	985
35	1083	1083
40	1180	1180
45	1278	1278
50	1375	1375
55	1473	1473
60	1570	1570
65	1668	1668
70	1765	1765
75	1863	1863
80	1960	1960
85	2058	2058
90	2155	2155
95	2253	2253
100	2350	2350
105	2448	2448.5
110	2545	2547
115	2643	2645.4
120	2740	2743.9
125	2838	2842.4
130	—	—
135	—	—
140	—	—
145	—	—
150	—	—

## 7.4 Device Functional Modes

The singular functional mode of the TMP23x is an analog output directly proportional to temperature.

## 8 Application and Implementation

### NOTE

Information in the following applications sections is not part of the TI component specification, and TI does not warrant its accuracy or completeness. TI's customers are responsible for determining suitability of components for their purposes. Customers should validate and test their design implementation to confirm system functionality.

### 8.1 Application Information

The features of the TMP235 make the series of devices designed for various general temperature-sensing applications. The TMP235 and TMP236 devices can operate down to a 2.3-V and a 3.1-V supply with 9- $\mu$ A power consumption, respectively. As a result, the series is designed for battery-powered applications. The TMP23x series is mounted in two surface mount technology packages (SC70 and SOT-23.)

### 8.2 Typical Application

#### 8.2.1 Connection to an ADC

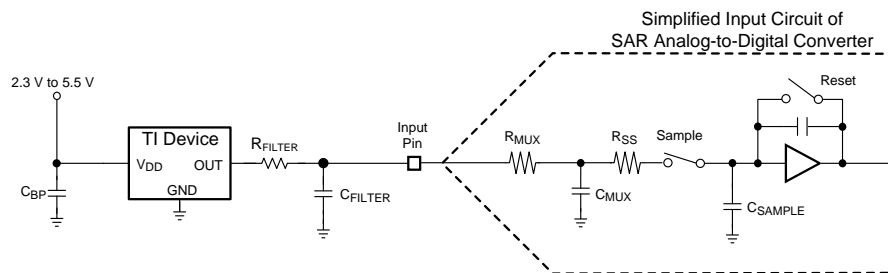

**Figure 13. Suggested Connections to an ADC Input Stage**

##### 8.2.1.1 Design Requirements

See [Figure 13](#) for suggested connections to an ADC input stage. Most CMOS-based ADCs have a sampled data comparator input structure. When the ADC charges the sampling capacitor ( $C_{SAMPLE}$ ), the capacitor requires instantaneous charge from the output of the analog source temperature sensor, such as the TMP23x. Therefore, the output impedance of the temperature sensor can affect ADC performance. In most cases, adding an external capacitor ( $C_{FILTER}$ ) mitigates design challenges. The TMP23x is specified and characterized with a 1000-pF maximum capacitive load ( $C_{LOAD}$ ). [Figure 13](#) shows  $C_{LOAD}$  as the sum of  $C_{FILTER} + C_{MUX} + C_{SAMPLE}$ . TI recommends maximizing the  $C_{FILTER}$  value while allowing for the maximum specified ADC input capacitance ( $C_{MUX} + C_{SAMPLE}$ ) to limit the total  $C_{LOAD}$  at 1000 pF. In most cases, a 680-pF  $C_{FILTER}$  provides a reasonable allowance for ADC input capacitance to minimize ADC sampling error and reduce noise coupling. An optional series resistor ( $R_{FILTER}$ ) and  $C_{FILTER}$  provides additional low-pass filtering to reject system level noise. TI recommends placing  $R_{FILTER}$  and  $C_{FILTER}$  as close as possible to the ADC input for optimal performance.

##### 8.2.1.2 Detailed Design Procedure

Depending on the input characteristics of the ADC, an external  $C_{FILTER}$  may be required. The value of  $C_{FILTER}$  depends on the size of the sampling capacitor ( $C_{SAMPLE}$ ) and the sampling frequency while observing a maximum  $C_{LOAD}$  of 1000 pF. The capacitor requirements can vary because the input stages of all ADCs are not identical. [Figure 13](#) shows a general ADC application as an example only.

## Typical Application (continued)

### 8.2.1.3 Application Curve

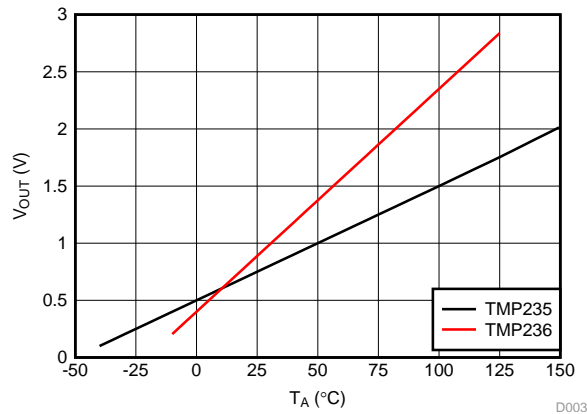

Figure 14. Output Voltage vs. Ambient

## 9 Power Supply Recommendations

The low supply current and supply range of the TMP23x allow the device to be easily powered from many sources.

Power supply bypassing is optional and is mainly dependent on the noise of the power supply. In noisy environments, TI recommends adding a 0.1- $\mu$ F capacitor from V+ to GND to bypass the power supply voltage. Larger capacitances may be required and are dependent on the noise of the power supply.

## 10 Layout

### 10.1 Layout Guidelines

The layout of the TMP23x series is simple. If a power supply bypass capacitor is used, the capacitor must be connected as [Layout Examples](#) shows.

### 10.2 Layout Examples

 VIA to ground plane

 VIA to power plane

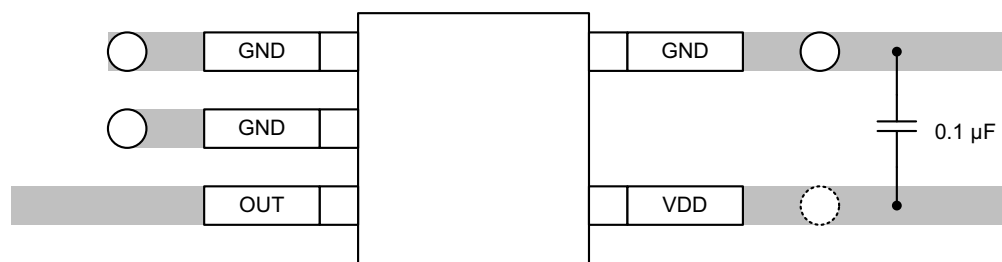

Figure 15. Recommended Layout: SC70 Package

## 11 Device and Documentation Support

### 11.1 Related Links

The table below lists quick access links. Categories include technical documents, support and community resources, tools and software, and quick access to sample or buy.

**Table 5. Related Links**

PARTS	PRODUCT FOLDER	ORDER NOW	TECHNICAL DOCUMENTS	TOOLS & SOFTWARE	SUPPORT & COMMUNITY
TMP235	<a href="#">Click here</a>	<a href="#">Click here</a>	<a href="#">Click here</a>	<a href="#">Click here</a>	<a href="#">Click here</a>
TMP236	<a href="#">Click here</a>	<a href="#">Click here</a>	<a href="#">Click here</a>	<a href="#">Click here</a>	<a href="#">Click here</a>

### 11.2 Receiving Notification of Documentation Updates

To receive notification of documentation updates, navigate to the device product folder on ti.com. In the upper right corner, click on *Alert me* to register and receive a weekly digest of any product information that has changed. For change details, review the revision history included in any revised document.

### 11.3 Community Resources

The following links connect to TI community resources. Linked contents are provided "AS IS" by the respective contributors. They do not constitute TI specifications and do not necessarily reflect TI's views; see TI's [Terms of Use](#).

**TI E2E™ Online Community** *TI's Engineer-to-Engineer (E2E) Community*. Created to foster collaboration among engineers. At e2e.ti.com, you can ask questions, share knowledge, explore ideas and help solve problems with fellow engineers.

**Design Support** *TI's Design Support* Quickly find helpful E2E forums along with design support tools and contact information for technical support.

### 11.4 Trademarks

E2E is a trademark of Texas Instruments.  
All other trademarks are the property of their respective owners.

### 11.5 Electrostatic Discharge Caution



This integrated circuit can be damaged by ESD. Texas Instruments recommends that all integrated circuits be handled with appropriate precautions. Failure to observe proper handling and installation procedures can cause damage.

ESD damage can range from subtle performance degradation to complete device failure. Precision integrated circuits may be more susceptible to damage because very small parametric changes could cause the device not to meet its published specifications.

### 11.6 Glossary

[SLYZ022](#) — *TI Glossary*.

This glossary lists and explains terms, acronyms, and definitions.

## 12 Mechanical, Packaging, and Orderable Information

The following pages include mechanical, packaging, and orderable information. This information is the most current data available for the designated devices. This data is subject to change without notice and revision of this document. For browser-based versions of this data sheet, refer to the left-hand navigation.

**PACKAGING INFORMATION**

Orderable Device	Status (1)	Package Type	Package Drawing	Pins	Package Qty	Eco Plan (2)	Lead/Ball Finish (6)	MSL Peak Temp (3)	Op Temp (°C)	Device Marking (4/5)	Samples
TMP235A2DCKR	ACTIVE	SC70	DCK	5	3000	Green (RoHS & no Sb/Br)	CU NIPDAU   CU NIPDAUAG	Level-1-260C-UNLIM	-40 to 150	19L	<a href="#">Samples</a>
TMP235A2DCKT	ACTIVE	SC70	DCK	5	250	Green (RoHS & no Sb/Br)	CU NIPDAU   CU NIPDAUAG	Level-1-260C-UNLIM	-40 to 150	19L	<a href="#">Samples</a>
TMP235A4DCKR	ACTIVE	SC70	DCK	5	3000	Green (RoHS & no Sb/Br)	CU NIPDAU   CU NIPDAUAG	Level-1-260C-UNLIM	-40 to 150	19M	<a href="#">Samples</a>
TMP235A4DCKT	ACTIVE	SC70	DCK	5	250	Green (RoHS & no Sb/Br)	CU NIPDAU   CU NIPDAUAG	Level-1-260C-UNLIM	-40 to 150	19M	<a href="#">Samples</a>
TMP236A2DCKR	PREVIEW	SC70	DCK	5	3000	Green (RoHS & no Sb/Br)	CU NIPDAU   CU NIPDAUAG	Level-1-260C-UNLIM	-40 to 125	1BS	
TMP236A2DCKT	PREVIEW	SC70	DCK	5	250	Green (RoHS & no Sb/Br)	CU NIPDAU   CU NIPDAUAG	Level-1-260C-UNLIM	-40 to 125	1BS	
TMP236A4DCKR	PREVIEW	SC70	DCK	5	3000	Green (RoHS & no Sb/Br)	CU NIPDAU   CU NIPDAUAG	Level-1-260C-UNLIM	-40 to 125	1BT	
TMP236A4DCKT	PREVIEW	SC70	DCK	5	250	Green (RoHS & no Sb/Br)	CU NIPDAU   CU NIPDAUAG	Level-1-260C-UNLIM	-40 to 125	1BT	

(1) The marketing status values are defined as follows:

**ACTIVE:** Product device recommended for new designs.

**LIFEBUY:** TI has announced that the device will be discontinued, and a lifetime-buy period is in effect.

**NRND:** Not recommended for new designs. Device is in production to support existing customers, but TI does not recommend using this part in a new design.

**PREVIEW:** Device has been announced but is not in production. Samples may or may not be available.

**OBSOLETE:** TI has discontinued the production of the device.

(2) **RoHS:** TI defines "RoHS" to mean semiconductor products that are compliant with the current EU RoHS requirements for all 10 RoHS substances, including the requirement that RoHS substance do not exceed 0.1% by weight in homogeneous materials. Where designed to be soldered at high temperatures, "RoHS" products are suitable for use in specified lead-free processes. TI may reference these types of products as "Pb-Free".

**RoHS Exempt:** TI defines "RoHS Exempt" to mean products that contain lead but are compliant with EU RoHS pursuant to a specific EU RoHS exemption.

**Green:** TI defines "Green" to mean the content of Chlorine (Cl) and Bromine (Br) based flame retardants meet JS709B low halogen requirements of <=1000ppm threshold. Antimony trioxide based flame retardants must also meet the <=1000ppm threshold requirement.

(3) MSL, Peak Temp. - The Moisture Sensitivity Level rating according to the JEDEC industry standard classifications, and peak solder temperature.

(4) There may be additional marking, which relates to the logo, the lot trace code information, or the environmental category on the device.

<sup>(5)</sup> Multiple Device Markings will be inside parentheses. Only one Device Marking contained in parentheses and separated by a "-" will appear on a device. If a line is indented then it is a continuation of the previous line and the two combined represent the entire Device Marking for that device.

<sup>(6)</sup> Lead/Ball Finish - Orderable Devices may have multiple material finish options. Finish options are separated by a vertical ruled line. Lead/Ball Finish values may wrap to two lines if the finish value exceeds the maximum column width.

**Important Information and Disclaimer:**The information provided on this page represents TI's knowledge and belief as of the date that it is provided. TI bases its knowledge and belief on information provided by third parties, and makes no representation or warranty as to the accuracy of such information. Efforts are underway to better integrate information from third parties. TI has taken and continues to take reasonable steps to provide representative and accurate information but may not have conducted destructive testing or chemical analysis on incoming materials and chemicals. TI and TI suppliers consider certain information to be proprietary, and thus CAS numbers and other limited information may not be available for release.

In no event shall TI's liability arising out of such information exceed the total purchase price of the TI part(s) at issue in this document sold by TI to Customer on an annual basis.

**TAPE AND REEL INFORMATION**

**QUADRANT ASSIGNMENTS FOR PIN 1 ORIENTATION IN TAPE**

\*All dimensions are nominal

Device	Package Type	Package Drawing	Pins	SPQ	Reel Diameter (mm)	Reel Width W1 (mm)	A0 (mm)	B0 (mm)	K0 (mm)	P1 (mm)	W (mm)	Pin1 Quadrant
TMP235A2DCKR	SC70	DCK	5	3000	178.0	9.0	2.4	2.5	1.2	4.0	8.0	Q3
TMP235A2DCKR	SC70	DCK	5	3000	180.0	8.4	2.47	2.3	1.25	4.0	8.0	Q3
TMP235A2DCKT	SC70	DCK	5	250	178.0	9.0	2.4	2.5	1.2	4.0	8.0	Q3
TMP235A2DCKT	SC70	DCK	5	250	180.0	8.4	2.47	2.3	1.25	4.0	8.0	Q3
TMP235A4DCKR	SC70	DCK	5	3000	178.0	9.0	2.4	2.5	1.2	4.0	8.0	Q3
TMP235A4DCKR	SC70	DCK	5	3000	180.0	8.4	2.47	2.3	1.25	4.0	8.0	Q3
TMP235A4DCKT	SC70	DCK	5	250	180.0	8.4	2.47	2.3	1.25	4.0	8.0	Q3
TMP235A4DCKT	SC70	DCK	5	250	178.0	9.0	2.4	2.5	1.2	4.0	8.0	Q3
TMP236A2DCKR	SC70	DCK	5	3000	178.0	9.0	2.4	2.5	1.2	4.0	8.0	Q3
TMP236A2DCKR	SC70	DCK	5	3000	180.0	8.4	2.47	2.3	1.25	4.0	8.0	Q3
TMP236A2DCKT	SC70	DCK	5	250	178.0	9.0	2.4	2.5	1.2	4.0	8.0	Q3
TMP236A2DCKT	SC70	DCK	5	250	180.0	8.4	2.47	2.3	1.25	4.0	8.0	Q3
TMP236A4DCKR	SC70	DCK	5	3000	178.0	9.0	2.4	2.5	1.2	4.0	8.0	Q3
TMP236A4DCKR	SC70	DCK	5	3000	180.0	8.4	2.47	2.3	1.25	4.0	8.0	Q3
TMP236A4DCKT	SC70	DCK	5	250	180.0	8.4	2.47	2.3	1.25	4.0	8.0	Q3
TMP236A4DCKT	SC70	DCK	5	250	178.0	9.0	2.4	2.5	1.2	4.0	8.0	Q3



**TAPE AND REEL BOX DIMENSIONS**

\*All dimensions are nominal

Device	Package Type	Package Drawing	Pins	SPQ	Length (mm)	Width (mm)	Height (mm)
TMP235A2DCKR	SC70	DCK	5	3000	180.0	180.0	18.0
TMP235A2DCKR	SC70	DCK	5	3000	183.0	183.0	20.0
TMP235A2DCKT	SC70	DCK	5	250	180.0	180.0	18.0
TMP235A2DCKT	SC70	DCK	5	250	183.0	183.0	20.0
TMP235A4DCKR	SC70	DCK	5	3000	180.0	180.0	18.0
TMP235A4DCKR	SC70	DCK	5	3000	183.0	183.0	20.0
TMP235A4DCKT	SC70	DCK	5	250	183.0	183.0	20.0
TMP235A4DCKT	SC70	DCK	5	250	180.0	180.0	18.0
TMP236A2DCKR	SC70	DCK	5	3000	180.0	180.0	18.0
TMP236A2DCKR	SC70	DCK	5	3000	183.0	183.0	20.0
TMP236A2DCKT	SC70	DCK	5	250	180.0	180.0	18.0
TMP236A2DCKT	SC70	DCK	5	250	183.0	183.0	20.0
TMP236A4DCKR	SC70	DCK	5	3000	180.0	180.0	18.0
TMP236A4DCKR	SC70	DCK	5	3000	183.0	183.0	20.0
TMP236A4DCKT	SC70	DCK	5	250	183.0	183.0	20.0
TMP236A4DCKT	SC70	DCK	5	250	180.0	180.0	18.0

DCK (R-PDSO-G5)

PLASTIC SMALL-OUTLINE PACKAGE

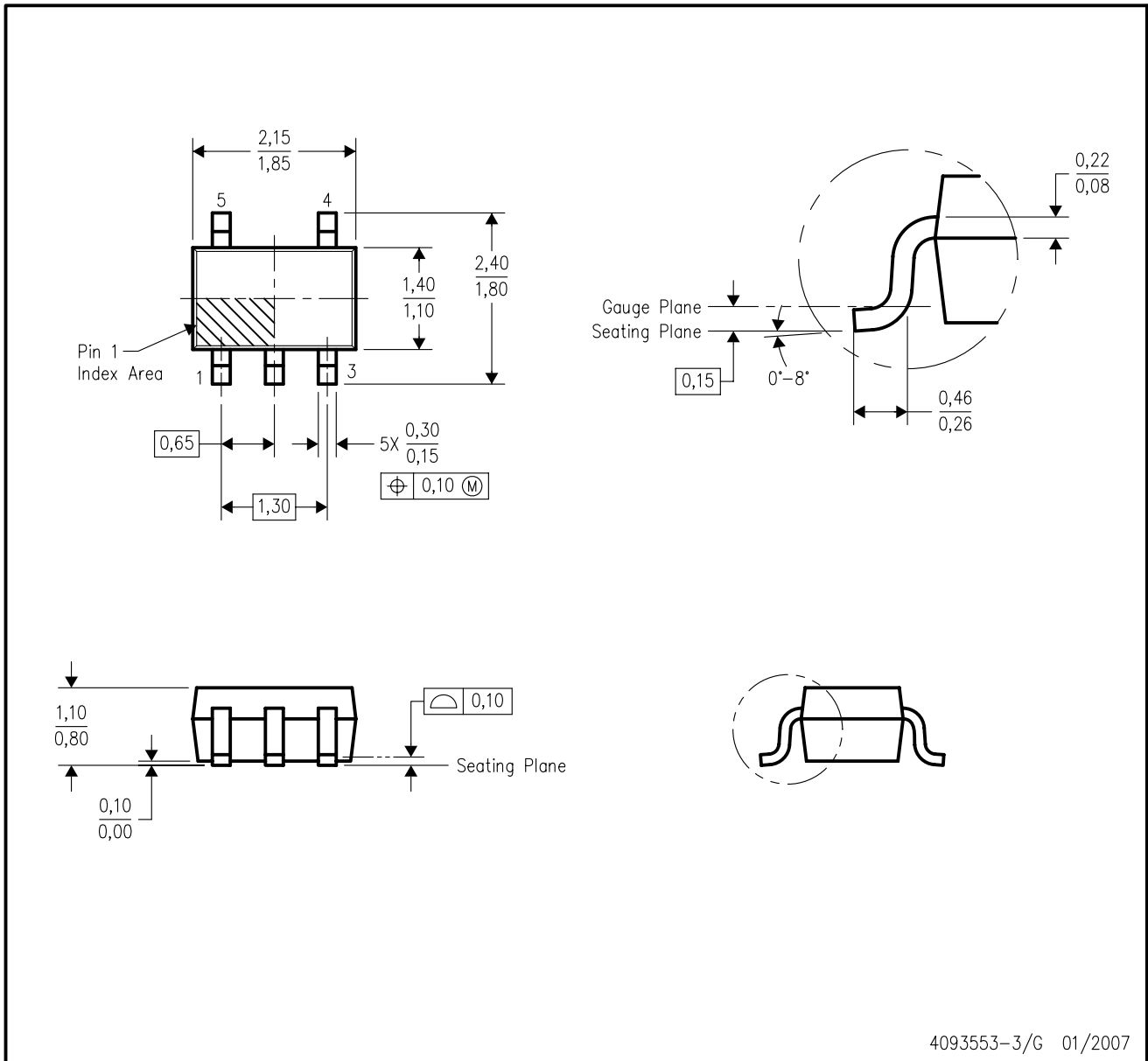

- NOTES:
- A. All linear dimensions are in millimeters.
  - B. This drawing is subject to change without notice.
  - C. Body dimensions do not include mold flash or protrusion. Mold flash and protrusion shall not exceed 0.15 per side.
  - D. Falls within JEDEC MO-203 variation AA.

## IMPORTANT NOTICE

Texas Instruments Incorporated (TI) reserves the right to make corrections, enhancements, improvements and other changes to its semiconductor products and services per JESD46, latest issue, and to discontinue any product or service per JESD48, latest issue. Buyers should obtain the latest relevant information before placing orders and should verify that such information is current and complete.

TI's published terms of sale for semiconductor products (<http://www.ti.com/sc/docs/stdterms.htm>) apply to the sale of packaged integrated circuit products that TI has qualified and released to market. Additional terms may apply to the use or sale of other types of TI products and services.

Reproduction of significant portions of TI information in TI data sheets is permissible only if reproduction is without alteration and is accompanied by all associated warranties, conditions, limitations, and notices. TI is not responsible or liable for such reproduced documentation. Information of third parties may be subject to additional restrictions. Resale of TI products or services with statements different from or beyond the parameters stated by TI for that product or service voids all express and any implied warranties for the associated TI product or service and is an unfair and deceptive business practice. TI is not responsible or liable for any such statements.

Buyers and others who are developing systems that incorporate TI products (collectively, "Designers") understand and agree that Designers remain responsible for using their independent analysis, evaluation and judgment in designing their applications and that Designers have full and exclusive responsibility to assure the safety of Designers' applications and compliance of their applications (and of all TI products used in or for Designers' applications) with all applicable regulations, laws and other applicable requirements. Designer represents that, with respect to their applications, Designer has all the necessary expertise to create and implement safeguards that (1) anticipate dangerous consequences of failures, (2) monitor failures and their consequences, and (3) lessen the likelihood of failures that might cause harm and take appropriate actions. Designer agrees that prior to using or distributing any applications that include TI products, Designer will thoroughly test such applications and the functionality of such TI products as used in such applications.

TI's provision of technical, application or other design advice, quality characterization, reliability data or other services or information, including, but not limited to, reference designs and materials relating to evaluation modules, (collectively, "TI Resources") are intended to assist designers who are developing applications that incorporate TI products; by downloading, accessing or using TI Resources in any way, Designer (individually or, if Designer is acting on behalf of a company, Designer's company) agrees to use any particular TI Resource solely for this purpose and subject to the terms of this Notice.

TI's provision of TI Resources does not expand or otherwise alter TI's applicable published warranties or warranty disclaimers for TI products, and no additional obligations or liabilities arise from TI providing such TI Resources. TI reserves the right to make corrections, enhancements, improvements and other changes to its TI Resources. TI has not conducted any testing other than that specifically described in the published documentation for a particular TI Resource.

Designer is authorized to use, copy and modify any individual TI Resource only in connection with the development of applications that include the TI product(s) identified in such TI Resource. NO OTHER LICENSE, EXPRESS OR IMPLIED, BY ESTOPPEL OR OTHERWISE TO ANY OTHER TI INTELLECTUAL PROPERTY RIGHT, AND NO LICENSE TO ANY TECHNOLOGY OR INTELLECTUAL PROPERTY RIGHT OF TI OR ANY THIRD PARTY IS GRANTED HEREIN, including but not limited to any patent right, copyright, mask work right, or other intellectual property right relating to any combination, machine, or process in which TI products or services are used. Information regarding or referencing third-party products or services does not constitute a license to use such products or services, or a warranty or endorsement thereof. Use of TI Resources may require a license from a third party under the patents or other intellectual property of the third party, or a license from TI under the patents or other intellectual property of TI.

TI RESOURCES ARE PROVIDED "AS IS" AND WITH ALL FAULTS. TI DISCLAIMS ALL OTHER WARRANTIES OR REPRESENTATIONS, EXPRESS OR IMPLIED, REGARDING RESOURCES OR USE THEREOF, INCLUDING BUT NOT LIMITED TO ACCURACY OR COMPLETENESS, TITLE, ANY EPIDEMIC FAILURE WARRANTY AND ANY IMPLIED WARRANTIES OF MERCHANTABILITY, FITNESS FOR A PARTICULAR PURPOSE, AND NON-INFRINGEMENT OF ANY THIRD PARTY INTELLECTUAL PROPERTY RIGHTS. TI SHALL NOT BE LIABLE FOR AND SHALL NOT DEFEND OR INDEMNIFY DESIGNER AGAINST ANY CLAIM, INCLUDING BUT NOT LIMITED TO ANY INFRINGEMENT CLAIM THAT RELATES TO OR IS BASED ON ANY COMBINATION OF PRODUCTS EVEN IF DESCRIBED IN TI RESOURCES OR OTHERWISE. IN NO EVENT SHALL TI BE LIABLE FOR ANY ACTUAL, DIRECT, SPECIAL, COLLATERAL, INDIRECT, PUNITIVE, INCIDENTAL, CONSEQUENTIAL OR EXEMPLARY DAMAGES IN CONNECTION WITH OR ARISING OUT OF TI RESOURCES OR USE THEREOF, AND REGARDLESS OF WHETHER TI HAS BEEN ADVISED OF THE POSSIBILITY OF SUCH DAMAGES.

Unless TI has explicitly designated an individual product as meeting the requirements of a particular industry standard (e.g., ISO/TS 16949 and ISO 26262), TI is not responsible for any failure to meet such industry standard requirements.

Where TI specifically promotes products as facilitating functional safety or as compliant with industry functional safety standards, such products are intended to help enable customers to design and create their own applications that meet applicable functional safety standards and requirements. Using products in an application does not by itself establish any safety features in the application. Designers must ensure compliance with safety-related requirements and standards applicable to their applications. Designer may not use any TI products in life-critical medical equipment unless authorized officers of the parties have executed a special contract specifically governing such use. Life-critical medical equipment is medical equipment where failure of such equipment would cause serious bodily injury or death (e.g., life support, pacemakers, defibrillators, heart pumps, neurostimulators, and implantables). Such equipment includes, without limitation, all medical devices identified by the U.S. Food and Drug Administration as Class III devices and equivalent classifications outside the U.S.

TI may expressly designate certain products as completing a particular qualification (e.g., Q100, Military Grade, or Enhanced Product). Designers agree that it has the necessary expertise to select the product with the appropriate qualification designation for their applications and that proper product selection is at Designers' own risk. Designers are solely responsible for compliance with all legal and regulatory requirements in connection with such selection.

Designer will fully indemnify TI and its representatives against any damages, costs, losses, and/or liabilities arising out of Designer's non-compliance with the terms and provisions of this Notice.