

TL081

TL081 Wide Bandwidth JFET Input Operational Amplifier



Literature Number: SNOSBW6A

TL081 Wide Bandwidth JFET Input Operational Amplifier

General Description

The TL081 is a low cost high speed JFET input operational amplifier with an internally trimmed input offset voltage (BI-FET II™ technology). The device requires a low supply current and yet maintains a large gain bandwidth product and a fast slew rate. In addition, well matched high voltage JFET input devices provide very low input bias and offset currents. The TL081 is pin compatible with the standard LM741 and uses the same offset voltage adjustment circuitry. This feature allows designers to immediately upgrade the overall performance of existing LM741 designs.

The TL081 may be used in applications such as high speed integrators, fast D/A converters, sample-and-hold circuits and many other circuits requiring low input offset voltage, low input bias current, high input impedance, high slew rate and wide bandwidth. The devices has low noise and offset voltage drift, but for applications where these requirements

are critical, the LF356 is recommended. If maximum supply current is important, however, the TL081C is the better choice.

Features

| | |
|---|-----------------------------|
| ■ Internally trimmed offset voltage | 15 mV |
| ■ Low input bias current | 50 pA |
| ■ Low input noise voltage | 25 nV/ $\sqrt{\text{Hz}}$ |
| ■ Low input noise current | 0.01 pA/ $\sqrt{\text{Hz}}$ |
| ■ Wide gain bandwidth | 4 MHz |
| ■ High slew rate | 13 V/ μs |
| ■ Low supply current | 1.8 mA |
| ■ High input impedance | $10^{12}\Omega$ |
| ■ Low total harmonic distortion $A_V = 10$, $R_L = 10\text{k}$, $V_O = 20\text{ Vp-p}$, $\text{BW} = 20\text{ Hz} - 20\text{ kHz}$ | <0.02% |
| ■ Low 1/f noise corner | 50 Hz |
| ■ Fast settling time to 0.01% | 2 μs |

Typical Connection

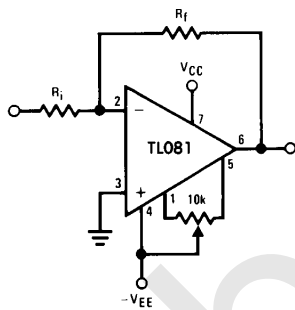

TL/H/8358-1

Simplified Schematic

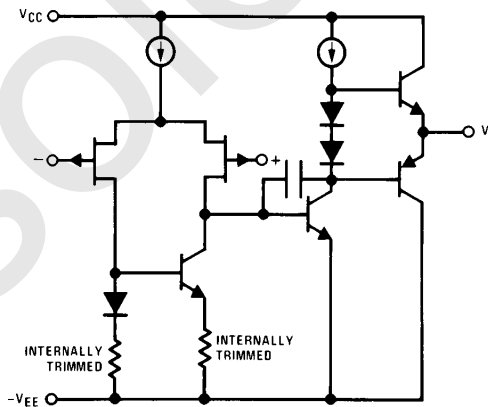

TL/H/8358-2

Connection Diagram

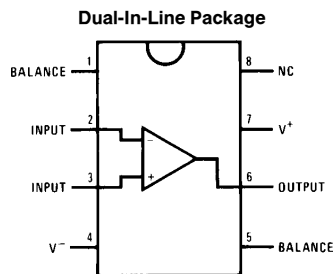

TL/H/8358-4

Order Number TL081CP
See NS Package Number N08E

Absolute Maximum Ratings

If Military/Aerospace specified devices are required, please contact the National Semiconductor Sales Office/Distributors for availability and specifications.

| | |
|-----------------------------------|--------------|
| Supply Voltage | ±18V |
| Power Dissipation (Notes 1 and 6) | 670 mW |
| Operating Temperature Range | 0°C to +70°C |
| T _{J(MAX)} | 115°C |
| Differential Input Voltage | ±30V |

| | |
|------------------------------------|-----------------|
| Input Voltage Range (Note 2) | ±15V |
| Output Short Circuit Duration | Continuous |
| Storage Temperature Range | –65°C to +150°C |
| Lead Temp. (Soldering, 10 seconds) | 260°C |
| θ _{JA} | 120°C/W |
| ESD rating to be determined. | |

DC Electrical Characteristics (Note 3)

| Symbol | Parameter | Conditions | TL081C | | | Units |
|----------------------|------------------------------------|--|----------|------------------|----------|--------------|
| | | | Min | Typ | Max | |
| V _{OS} | Input Offset Voltage | R _S = 10 kΩ, T _A = 25°C Over Temperature | | 5 | 15 20 | mV mV |
| ΔV _{OS} /ΔT | Average TC of Input Offset Voltage | R _S = 10 kΩ | | 10 | | μV/°C |
| I _{OS} | Input Offset Current | T _J = 25°C, (Notes 3, 4) T _J ≤ 70°C | | 25 | 100 4 | pA nA |
| I _B | Input Bias Current | T _J = 25°C, (Notes 3, 4) T _J ≤ 70°C | | 50 | 200 8 | pA nA |
| R _{IN} | Input Resistance | T _J = 25°C | | 10 ¹² | | Ω |
| A _{VOL} | Large Signal Voltage Gain | V _S = ±15V, T _A = 25°C V _O = ±10V, R _L = 2 kΩ Over Temperature | 25 15 | 100 | | V/mV V/mV |
| V _O | Output Voltage Swing | V _S = ±15V, R _L = 10 kΩ | ±12 | ±13.5 | | V |
| V _{CM} | Input Common-Mode Voltage Range | V _S = ±15V | ±11 | +15 –12 | | V V |
| CMRR | Common-Mode Rejection Ratio | R _S ≤ 10 kΩ | 70 | 100 | | dB |
| PSRR | Supply Voltage Rejection Ratio | (Note 5) | 70 | 100 | | dB |
| I _S | Supply Current | | | 1.8 | 2.8 | mA |

AC Electrical Characteristics (Note 3)

| Symbol | Parameter | Conditions | TL081C | | | Units |
|----------------|--------------------------------|--|--------|------|-----|--------|
| | | | Min | Typ | Max | |
| SR | Slew Rate | V _S = ±15V, T _A = 25°C | | 13 | | V/μs |
| GBW | Gain Bandwidth Product | V _S = ±15V, T _A = 25°C | | 4 | | MHz |
| e _n | Equivalent Input Noise Voltage | T _A = 25°C, R _S = 100Ω, f = 1000 Hz | | 25 | | nV/√Hz |
| i _n | Equivalent Input Noise Current | T _J = 25°C, f = 1000 Hz | | 0.01 | | pA/√Hz |

Note 1: For operating at elevated temperature, the device must be derated based on a thermal resistance of 120°C/W junction to ambient for N package.

Note 2: Unless otherwise specified the absolute maximum negative input voltage is equal to the negative power supply voltage.

Note 3: These specifications apply for V_S = ±15V and 0°C ≤ T_A ≤ +70°C. V_{OS}, I_B and I_{OS} are measured at V_{CM} = 0.

Note 4: The input bias currents are junction leakage currents which approximately double for every 10°C increase in the junction temperature, T_J. Due to the limited production test time, the input bias currents measured are correlated to junction temperature. In normal operation the junction temperature rises above the ambient temperature as a result of internal power dissipation, P_D. T_J = T_A + θ_{JA} P_D where θ_{JA} is the thermal resistance from junction to ambient. Use of a heat sink is recommended if input bias current is to be kept to a minimum.

Note 5: Supply voltage rejection ratio is measured for both supply magnitudes increasing or decreasing simultaneously in accordance with common practice from V_S = ±5V to ±15V.

Note 6: Max. Power Dissipation is defined by the package characteristics. Operating the part near the Max. Power Dissipation may cause the part to operate outside guaranteed limits.

Typical Performance Characteristics

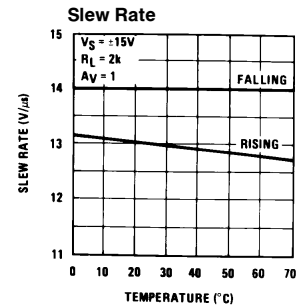
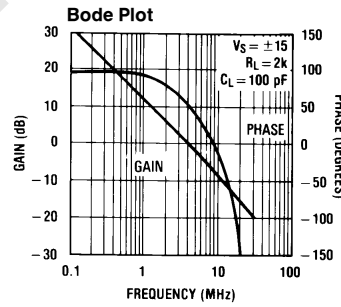
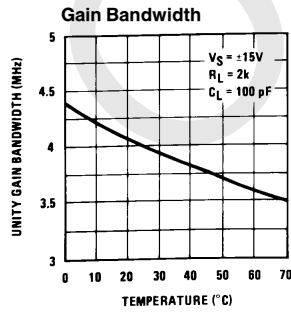
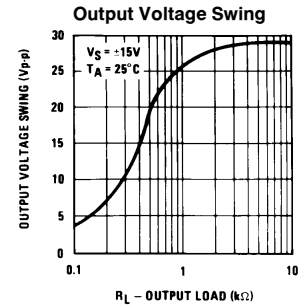
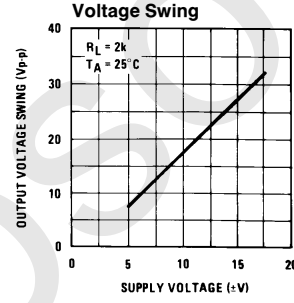
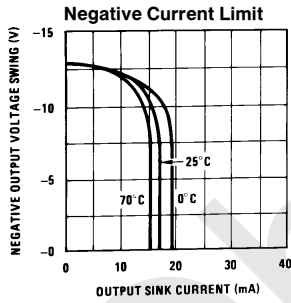
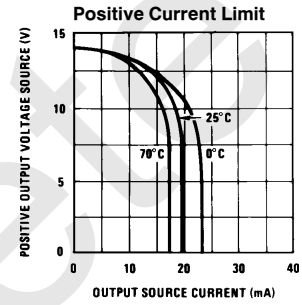
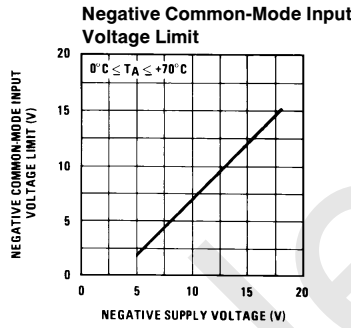
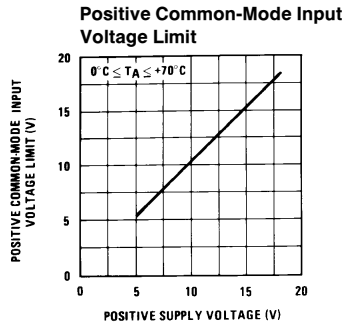
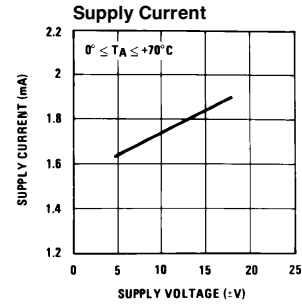
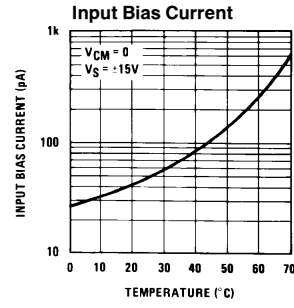
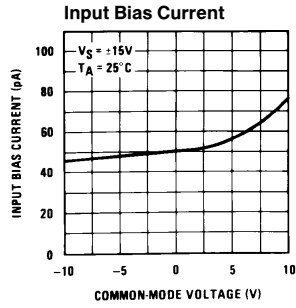

TL/H/8358-5

Typical Performance Characteristics (Continued)

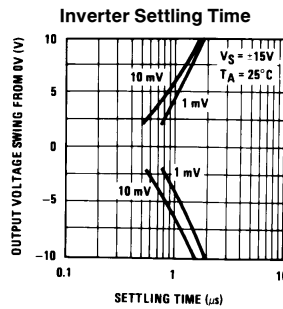
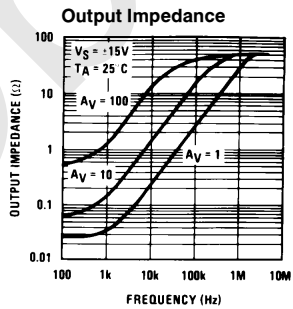
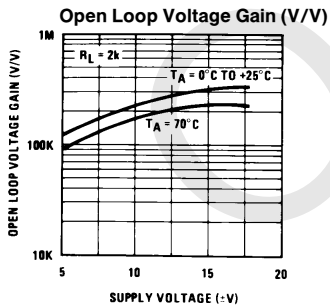
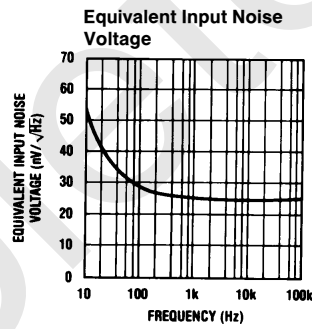
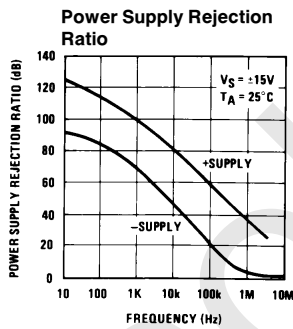
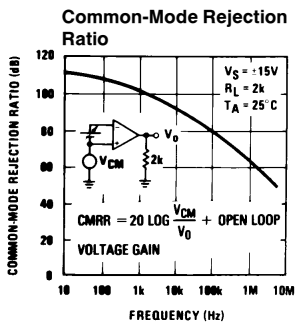
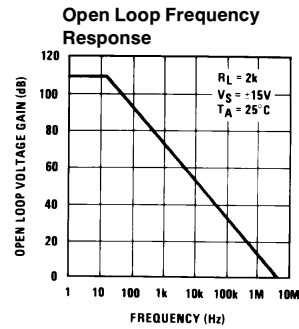
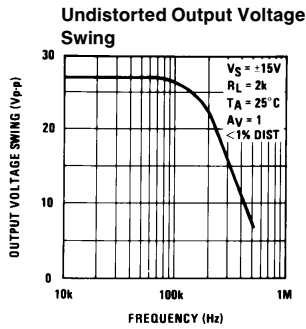
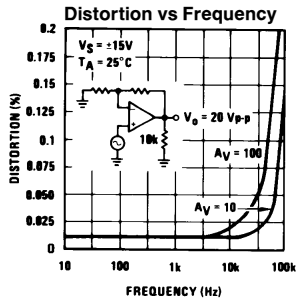

TL/H/8358-6

Pulse Response

Small Signal Inverting

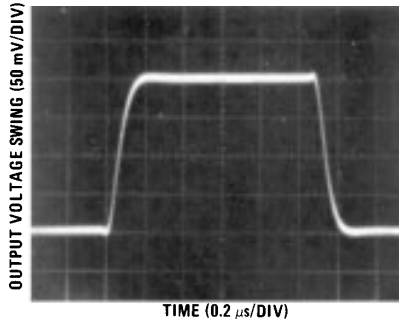

TL/H/8358-7

Small Signal Non-Inverting

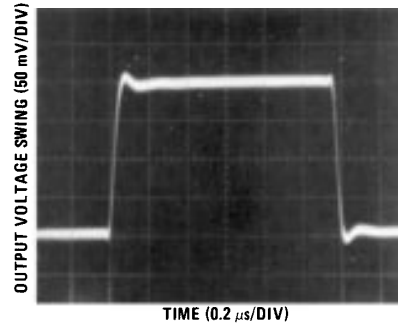

TL/H/8358-13

Large Signal Inverting

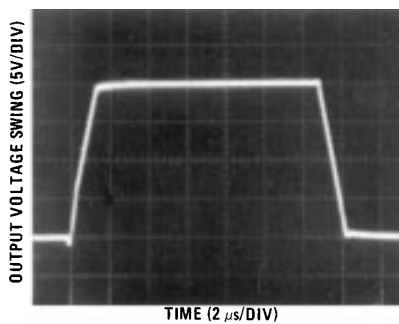

TL/H/8358-14

Large Signal Non-Inverting

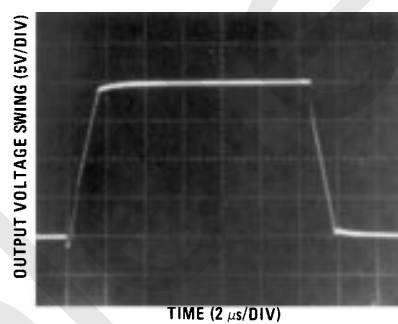

TL/H/8358-15

Current Limit ($R_L = 100\Omega$)

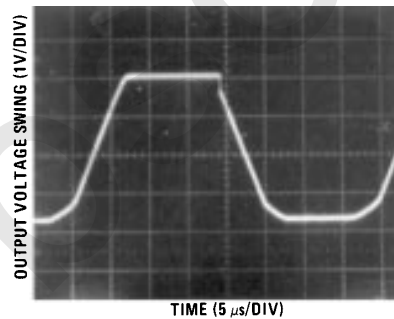

TL/H/8358-16

Application Hints

The TL081 is an op amp with an internally trimmed input offset voltage and JFET input devices (BI-FET II). These JFETs have large reverse breakdown voltages from gate to source and drain eliminating the need for clamps across the inputs. Therefore, large differential input voltages can easily be accommodated without a large increase in input current. The maximum differential input voltage is independent of the supply voltages. However, neither of the input voltages should be allowed to exceed the negative supply as this

will cause large currents to flow which can result in a destroyed unit.

Exceeding the negative common-mode limit on either input will force the output to a high state, potentially causing a reversal of phase to the output.

Exceeding the negative common-mode limit on both inputs will force the amplifier output to a high state. In neither case does a latch occur since raising the input back within the

Application Hints (Continued)

common-mode range again puts the input stage and thus the amplifier in a normal operating mode.

Exceeding the positive common-mode limit on a single input will not change the phase of the output; however, if both inputs exceed the limit, the output of the amplifier will be forced to a high state.

The amplifier will operate with a common-mode input voltage equal to the positive supply; however, the gain bandwidth and slew rate may be decreased in this condition. When the negative common-mode voltage swings to within 3V of the negative supply, an increase in input offset voltage may occur.

The TL081 is biased by a zener reference which allows normal circuit operation on $\pm 4V$ power supplies. Supply voltages less than these may result in lower gain bandwidth and slew rate.

The TL081 will drive a 2 k Ω load resistance to $\pm 10V$ over the full temperature range of 0°C to +70°C. If the amplifier is forced to drive heavier load currents, however, an increase in input offset voltage may occur on the negative voltage swing and finally reach an active current limit on both positive and negative swings.

Precautions should be taken to ensure that the power supply for the integrated circuit never becomes reversed in polarity or that the unit is not inadvertently installed backwards in a socket as an unlimited current surge through the

resulting forward diode within the IC could cause fusing of the internal conductors and result in a destroyed unit.

Because these amplifiers are JFET rather than MOSFET input op amps they do not require special handling.

As with most amplifiers, care should be taken with lead dress, component placement and supply decoupling in order to ensure stability. For example, resistors from the output to an input should be placed with the body close to the input to minimize "pick-up" and maximize the frequency of the feedback pole by minimizing the capacitance from the input to ground.

A feedback pole is created when the feedback around any amplifier is resistive. The parallel resistance and capacitance from the input of the device (usually the inverting input) to AC ground set the frequency of the pole. In many instances the frequency of this pole is much greater than the expected 3 dB frequency of the closed loop gain and consequently there is negligible effect on stability margin. However, if the feedback pole is less than approximately 6 times the expected 3 dB frequency a lead capacitor should be placed from the output to the input of the op amp. The value of the added capacitor should be such that the RC time constant of this capacitor and the resistance it parallels is greater than or equal to the original feedback pole time constant.

Detailed Schematic

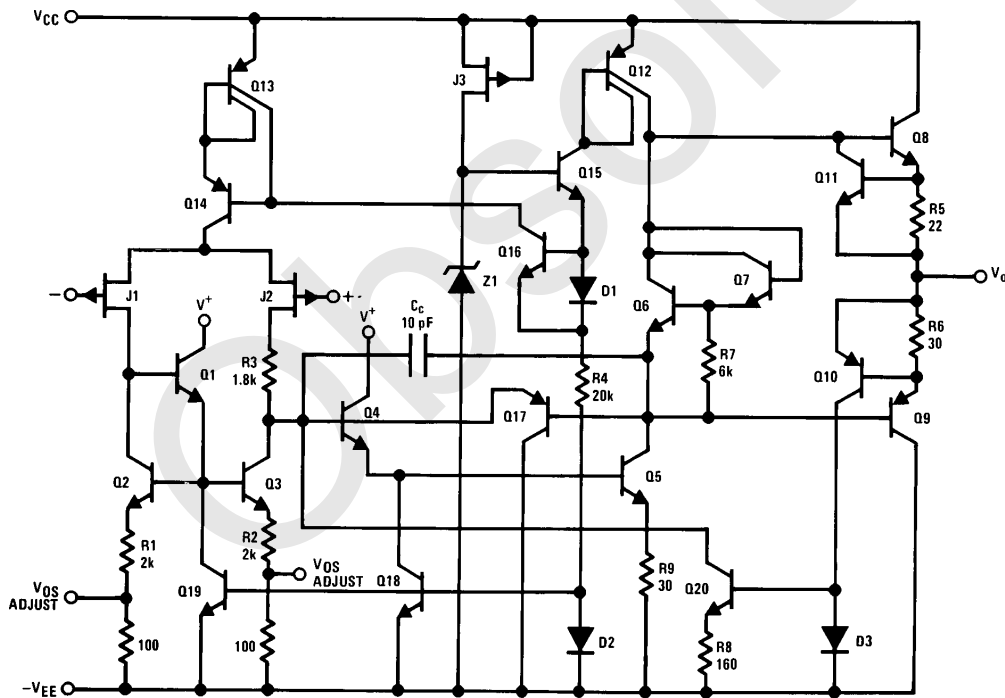

TL/H/8358-8

Typical Applications

Supply Current Indicator/Limiter

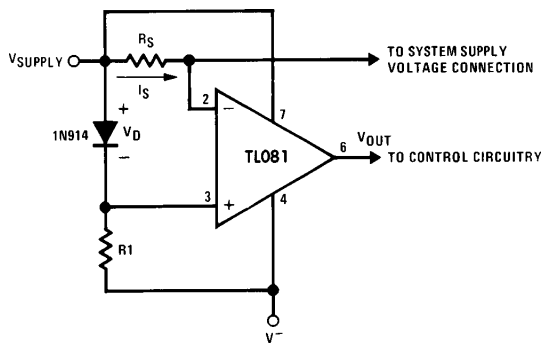

- V_{OUT} switches high when $R_S I_S > V_D$

TL/H/8358-9

Hi- Z_{IN} Inverting Amplifier

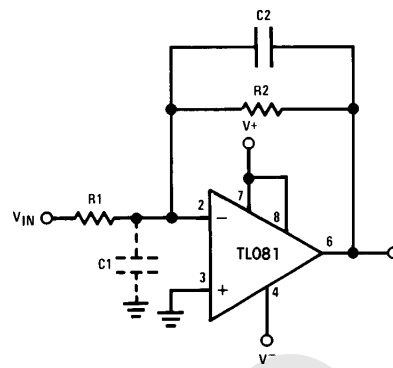

TL/H/8358-10

Parasitic input capacitance $C_1 \approx (3 \text{ pF for TL081 plus any additional layout capacitance})$ interacts with feedback elements and creates undesirable high frequency pole. To compensate, add C_2 such that $R_2 C_2 \approx R_1 C_1$.

Ultra-Low (or High) Duty Cycle Pulse Generator

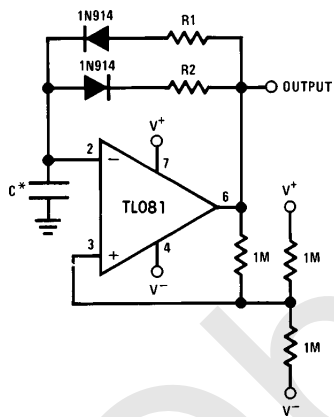

TL/H/8358-11

- $t_{OUTPUT \text{ HIGH}} \approx R_1 C \ln \frac{4.8 - 2V_S}{4.8 - V_S}$
 - $t_{OUTPUT \text{ LOW}} \approx R_2 C \ln \frac{2V_S - 7.8}{V_S - 7.8}$
- where $V_S = V^+ + |V^-|$
 *low leakage capacitor

Long Time Integrator

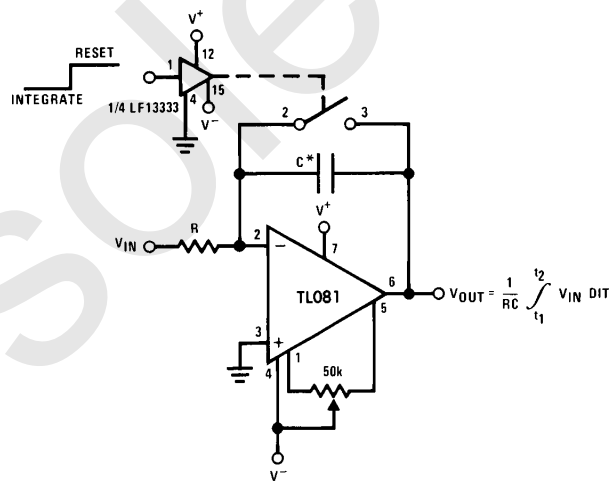

TL/H/8358-12

- * Low leakage capacitor
- 50k pot used for less sensitive V_{OS} adjust

TL081 Wide Bandwidth JFET Input Operational Amplifier

Physical Dimensions inches (millimeters)

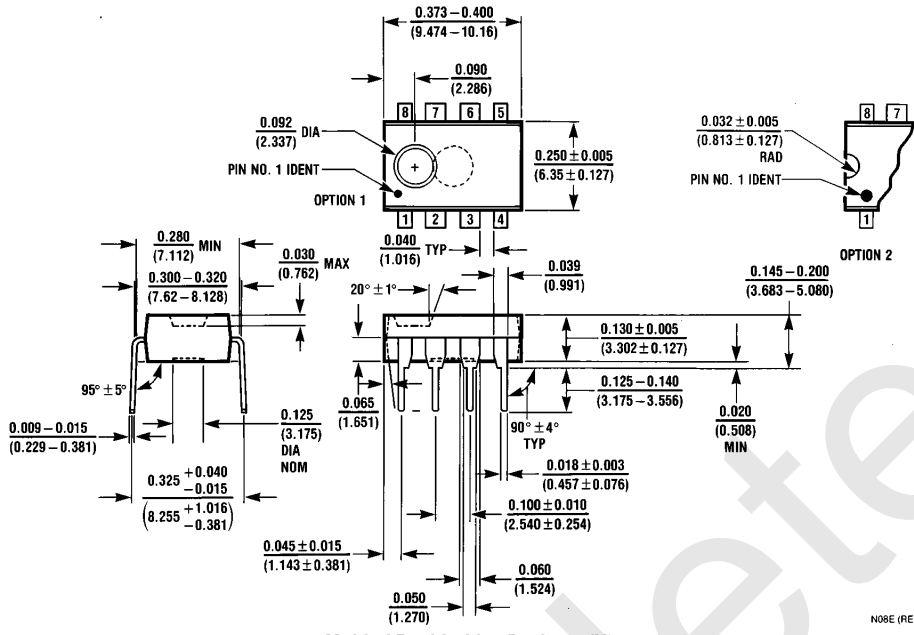

Molded Dual-In-Line Package (N)
Order Number TL081CP
NS Package Number N08E

N08E (REV F)

LIFE SUPPORT POLICY

NATIONAL'S PRODUCTS ARE NOT AUTHORIZED FOR USE AS CRITICAL COMPONENTS IN LIFE SUPPORT DEVICES OR SYSTEMS WITHOUT THE EXPRESS WRITTEN APPROVAL OF THE PRESIDENT OF NATIONAL SEMICONDUCTOR CORPORATION. As used herein:

1. Life support devices or systems are devices or systems which, (a) are intended for surgical implant into the body, or (b) support or sustain life, and whose failure to perform, when properly used in accordance with instructions for use provided in the labeling, can be reasonably expected to result in a significant injury to the user.
2. A critical component is any component of a life support device or system whose failure to perform can be reasonably expected to cause the failure of the life support device or system, or to affect its safety or effectiveness.



National Semiconductor Corporation
 1111 West Bardin Road
 Arlington, TX 76017
 Tel: 1(800) 272-9959
 Fax: 1(800) 737-7018

National Semiconductor Europe
 Fax: (+49) 0-180-530 85 86
 Email: cnjwge@tevm2.nsc.com
 Deutsch Tel: (+49) 0-180-530 85 85
 English Tel: (+49) 0-180-532 78 32
 Français Tel: (+49) 0-180-532 93 58
 Italiano Tel: (+49) 0-180-534 16 80

National Semiconductor Hong Kong Ltd.
 19th Floor, Straight Block,
 Ocean Centre, 5 Canton Rd.
 Tsimshatsui, Kowloon
 Hong Kong
 Tel: (852) 2737-1600
 Fax: (852) 2736-9960

National Semiconductor Japan Ltd.
 Tel: 81-043-299-2309
 Fax: 81-043-299-2408

National does not assume any responsibility for use of any circuitry described, no circuit patent licenses are implied and National reserves the right at any time without notice to change said circuitry and specifications.

IMPORTANT NOTICE

Texas Instruments Incorporated and its subsidiaries (TI) reserve the right to make corrections, modifications, enhancements, improvements, and other changes to its products and services at any time and to discontinue any product or service without notice. Customers should obtain the latest relevant information before placing orders and should verify that such information is current and complete. All products are sold subject to TI's terms and conditions of sale supplied at the time of order acknowledgment.

TI warrants performance of its hardware products to the specifications applicable at the time of sale in accordance with TI's standard warranty. Testing and other quality control techniques are used to the extent TI deems necessary to support this warranty. Except where mandated by government requirements, testing of all parameters of each product is not necessarily performed.

TI assumes no liability for applications assistance or customer product design. Customers are responsible for their products and applications using TI components. To minimize the risks associated with customer products and applications, customers should provide adequate design and operating safeguards.

TI does not warrant or represent that any license, either express or implied, is granted under any TI patent right, copyright, mask work right, or other TI intellectual property right relating to any combination, machine, or process in which TI products or services are used. Information published by TI regarding third-party products or services does not constitute a license from TI to use such products or services or a warranty or endorsement thereof. Use of such information may require a license from a third party under the patents or other intellectual property of the third party, or a license from TI under the patents or other intellectual property of TI.

Reproduction of TI information in TI data books or data sheets is permissible only if reproduction is without alteration and is accompanied by all associated warranties, conditions, limitations, and notices. Reproduction of this information with alteration is an unfair and deceptive business practice. TI is not responsible or liable for such altered documentation. Information of third parties may be subject to additional restrictions.

Resale of TI products or services with statements different from or beyond the parameters stated by TI for that product or service voids all express and any implied warranties for the associated TI product or service and is an unfair and deceptive business practice. TI is not responsible or liable for any such statements.

TI products are not authorized for use in safety-critical applications (such as life support) where a failure of the TI product would reasonably be expected to cause severe personal injury or death, unless officers of the parties have executed an agreement specifically governing such use. Buyers represent that they have all necessary expertise in the safety and regulatory ramifications of their applications, and acknowledge and agree that they are solely responsible for all legal, regulatory and safety-related requirements concerning their products and any use of TI products in such safety-critical applications, notwithstanding any applications-related information or support that may be provided by TI. Further, Buyers must fully indemnify TI and its representatives against any damages arising out of the use of TI products in such safety-critical applications.

TI products are neither designed nor intended for use in military/aerospace applications or environments unless the TI products are specifically designated by TI as military-grade or "enhanced plastic." Only products designated by TI as military-grade meet military specifications. Buyers acknowledge and agree that any such use of TI products which TI has not designated as military-grade is solely at the Buyer's risk, and that they are solely responsible for compliance with all legal and regulatory requirements in connection with such use.

TI products are neither designed nor intended for use in automotive applications or environments unless the specific TI products are designated by TI as compliant with ISO/TS 16949 requirements. Buyers acknowledge and agree that, if they use any non-designated products in automotive applications, TI will not be responsible for any failure to meet such requirements.

Following are URLs where you can obtain information on other Texas Instruments products and application solutions:

Products

| | |
|------------------------|--|
| Audio | www.ti.com/audio |
| Amplifiers | amplifier.ti.com |
| Data Converters | dataconverter.ti.com |
| DLP® Products | www.dlp.com |
| DSP | dsp.ti.com |
| Clocks and Timers | www.ti.com/clocks |
| Interface | interface.ti.com |
| Logic | logic.ti.com |
| Power Mgmt | power.ti.com |
| Microcontrollers | microcontroller.ti.com |
| RFID | www.ti-rfid.com |
| OMAP Mobile Processors | www.ti.com/omap |
| Wireless Connectivity | www.ti.com/wirelessconnectivity |

Applications

| | |
|-------------------------------|--|
| Communications and Telecom | www.ti.com/communications |
| Computers and Peripherals | www.ti.com/computers |
| Consumer Electronics | www.ti.com/consumer-apps |
| Energy and Lighting | www.ti.com/energy |
| Industrial | www.ti.com/industrial |
| Medical | www.ti.com/medical |
| Security | www.ti.com/security |
| Space, Avionics and Defense | www.ti.com/space-avionics-defense |
| Transportation and Automotive | www.ti.com/automotive |
| Video and Imaging | www.ti.com/video |

TI E2E Community Home Page

e2e.ti.com

Mailing Address: Texas Instruments, Post Office Box 655303, Dallas, Texas 75265
Copyright © 2011, Texas Instruments Incorporated