

150mA, 10V LDO with Shutdown

FEATURES

- Low Dropout Voltage 200 mV typ at 80 mA
380 mV typ at 160 mA
- High Output Current 180 mA ($V_{OUT} = 5.0V$)
- High Accuracy Output Voltage $\pm 2\%$
- Low Power Consumption 11 μA (Oper.)
..... 0.1 μA (Shutdown)
- Low Temperature Drift ± 100 ppm/ $^{\circ}C$ Typ
- Excellent Line Regulation 0.2%/V Typ
- Space-Saving 5-Pin SOT-23A Package
- Short Circuit Protection
- Standard 2.5V, 3.0V and 3.3V Output Voltages
- Voltage Outputs Available from 2.1V to 5.0V in 100 mV Steps

APPLICATIONS

- Battery Powered Devices
- Cameras and Portable Video Equipment
- Pagers and Cellular Phones
- Solar Powered Instruments
- Consumer Products

TYPICAL APPLICATION

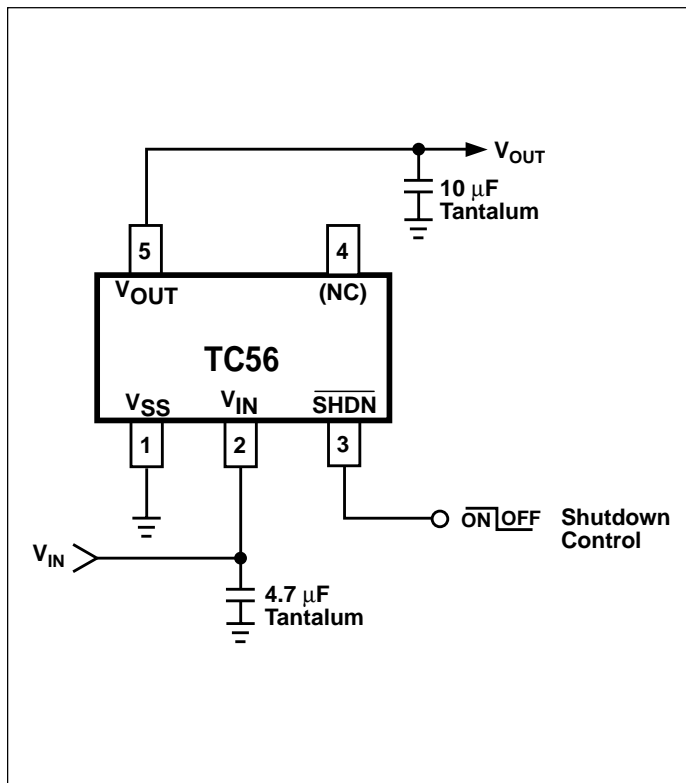

GENERAL DESCRIPTION

The TC56 is a low supply current (11 μA typ at $V_{OUT} = 3V$), low dropout CMOS linear regulator, with a 10V maximum input voltage range. CMOS construction eliminates wasted ground current typical of bipolar regulators for greater system efficiencies, and longer operating time in battery-powered systems. The TC56 enters shutdown mode when the shutdown control input (\overline{SHDN}) is low. During shutdown, the regulator is shut off, and supply current falls to 0.1 μA maximum. Normal operation is restored when \overline{SHDN} is returned to a logic high. The TC56 is available in factory-programmed output voltage settings between 2.1V and 5.0V in 100 mV increments. Low current consumption, 10V supply tolerance and space-saving 5-pin SOT-23A packaging make the TC56 ideal for a wide variety of applications.

ORDERING INFORMATION

Part No.	Output Voltage (V)*	Package	Temperature Range (T_A)
TC562502ECT	2.5	5-Pin SOT-23A	-40 $^{\circ}C$ to +85 $^{\circ}C$
TC563002ECT	3.0	5-Pin SOT-23A	-40 $^{\circ}C$ to +85 $^{\circ}C$
TC563302ECT	3.3	5-Pin SOT-23A	-40 $^{\circ}C$ to +85 $^{\circ}C$

Note: *Other output voltages available. Please contact Microchip Technology Inc. for details.

PIN CONFIGURATIONS

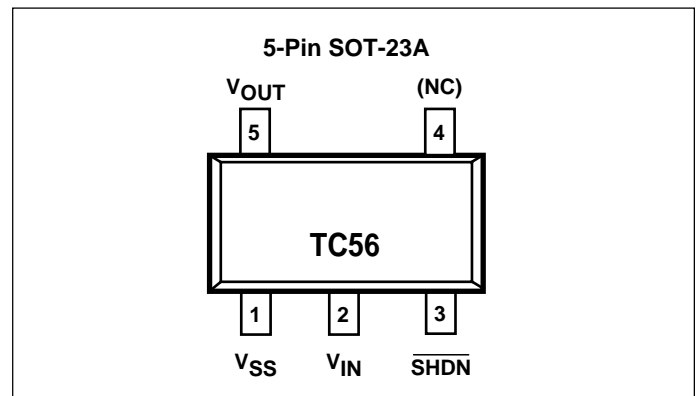

TC56

ABSOLUTE MAXIMUM RATINGS*

Input Voltage (V_{IN})	+12V
Output Current (I_{OUT})	500 mA
Output Voltage (V_{OUT})	$V_{SS} - 0.3V$ to $V_{IN} + 0.3V$
SHDN Input Voltage (V_{SHDN})	$V_{SS} - 0.3V$ to $V_{IN} + 0.3V$
Operating Temperature Range	-40°C to +85°C
Storage Temperature Range	-40°C to +125°C

Power Dissipation

SOT-23 150 mW

*Static-sensitive device. Unused devices must be stored in conductive material. Protect devices from static discharge and static fields. Stresses above those listed under Absolute Maximum Ratings may cause permanent damage to the device. These are stress ratings only and functional operation of the device at these or any other conditions above those indicated in the operational sections of the specifications is not implied. Exposure to Absolute Maximum Rating Conditions for extended periods may affect device reliability.

ELECTRICAL CHARACTERISTICS: $V_{IN} = V_{OUT} + 1V$, $T_A = 25^\circ C$, $C_{IN} = 4.7 \mu F$, $C_{OUT} = 10 \mu F$ unless otherwise specified.

Symbol	Parameter	Test Conditions	Min	Typ	Max	Unit	
V_{IN}	Input Voltage		—	—	10	V	
V_{OUT}	Output Voltage	$I_{OUT} = 40 \text{ mA}$; Note 1	$0.98 \times V_R$	$V_R \pm 0.5\%$	$1.02 \times V_R$	V	
$I_{OUT(MAX)}$	Maximum Output Current	$V_R \geq 2.7V$ /Note 1	$V_{OUT} = 3V$	150	—	—	mA
		$V_R \geq 4.5V$ /Note 1	$V_{OUT} = 5V$	180	—	—	
ΔV_{OUT}	Load Regulation	$1 \text{ mA} \leq I_{OUT} \leq 80 \text{ mA}$	$V_{OUT} = 3V$	—	45	90	mV
			$V_{OUT} = 5V$	—	40	80	
$V_{IN} - V_{OUT}$	Dropout Voltage (Note 2)	$I_{OUT} = 80 \text{ mA}$	$V_{OUT} = 3V$	—	200	395	mV
		$I_{OUT} = 160 \text{ mA}$	$V_{OUT} = 3V$	—	380	770	
		$I_{OUT} = 100 \text{ mA}$	$V_{OUT} = 5V$	—	165	330	
		$I_{OUT} = 200 \text{ mA}$	$V_{OUT} = 5V$	—	330	660	
I_{DD}	Supply Current	$V_{SHDN} = V_{IN} = 4V$		—	11	19	μA
		$V_{SHDN} = V_{IN} = 6V$		—	13	21	
I_{SHDN}	Shutdown Supply Current	$V_{SHDN} = GND$	—	—	0.1	μA	
$\Delta V_{OUT}/\Delta V_{IN}$	Line Regulation	$I_{OUT} = 40 \text{ mA}$, $4V \leq V_{IN} \leq 10V$	—	0.2	0.3	%/V	
$\Delta V_{OUT}/\Delta T$	V_{OUT} Temp. Coefficient	$I_{OUT} = 10 \text{ mA}$, $-40^\circ C < T_J < +85^\circ C$	—	± 100	—	ppm/ $^\circ C$	
V_{IH}	SHDN Input High Logic Threshold		1.5	—	—	V	
V_{IL}	SHDN Input Low Logic Threshold		—	—	0.25	V	
I_{IH}	SHDN Input Current @ V_{IH}	$V_{SHDN} = V_{IN}$	—	—	5.0	μA	
I_{IL}	SHDN Input Current @ V_{IL}	$V_{SHDN} = GND$	-0.2	-0.05	0	μA	

- Notes:**
- V_R is the regulator output voltage setting.
 - Dropout voltage is defined as the input to output differential at which the output voltage drops 2% below its nominal value measured at a 1V differential.

PIN DESCRIPTION

Pin Number	Name	Description
1	V_{SS}	Ground
2	V_{IN}	Supply Voltage Input
3	SHDN	Shutdown Input
4	(NC)	No Connection
5	V_{OUT}	Regulated Voltage Output

DETAILED DESCRIPTION

The TC56 is a precision, fixed output LDO. Unlike bipolar regulators, the TC56 supply current does not increase with load current.

Output Capacitor

A 10 μF capacitor from V_{OUT} to ground is recommended. The output capacitor should have an effective series resistance of 5Ω or less, and a resonant frequency above 1MHz. It is recommended that a 4.7 μF capacitor be connected from V_{IN} to GND. Tantalum capacitors are recommended. When operating from sources other than batteries, supply-noise rejection and transient response can be improved by increasing the value of the input and output capacitors and employing passive filtering techniques.

Shutdown Input

The TC56 enters a low power shutdown mode when the shutdown control input (SHDN) is low. During shutdown, the regulator is disabled and supply current is reduced to 0.1 μA . Normal operation is restored when SHDN is driven high. If not required, the SHDN input can be tied to V_{IN} .

Thermal Considerations

Power Dissipation

The amount of power the regulator dissipates is primarily a function of input and output voltage, and output current. The following equation is used to calculate worst case actual power dissipation:

$$P_D \approx (V_{\text{IN}(\text{MAX})} - V_{\text{OUT}(\text{MIN})})I_{\text{LOAD}(\text{MAX})}$$

Equation 1.

Where:

P_D = Worst case actual power dissipation

$V_{\text{IN}(\text{MAX})}$ = Maximum voltage on V_{IN}

$V_{\text{OUT}(\text{MIN})}$ = Minimum regulator output voltage

$I_{\text{LOAD}(\text{MAX})}$ = Maximum output (load) current

The maximum allowable power dissipation (Equation 2) is a function of the maximum ambient temperature ($T_{\text{A}(\text{MAX})}$), the maximum allowable die temperature (125°C) and the thermal resistance from junction-to-air (θ_{JA}). The 5-pin SOT-23A package has a θ_{JA} of approximately 220°C/Watt when mounted on a single layer FR4 dielectric copper clad PC board.

$$P_{\text{D}(\text{MAX})} = \frac{(T_{\text{J}(\text{MAX})} - T_{\text{A}(\text{MAX})})}{\theta_{\text{JA}}}$$

Equation 2.

Where all terms are previously defined.

Equation 1 can be used in conjunction with Equation 2 to ensure regulator thermal operation is within limits. For example:

Given:

$$V_{\text{IN}(\text{MAX})} = 3.0\text{V} \pm 10\%$$

$$V_{\text{OUT}(\text{MIN})} = 2.7\text{V} - 2\%$$

$$I_{\text{LOAD}} = 98 \text{ mA}$$

$$T_{\text{A}(\text{MAX})} = 55^\circ\text{C}$$

- Find: 1. Actual power dissipation
2. Maximum allowable dissipation

Actual power dissipation:

$$\begin{aligned} P_D &\approx (V_{\text{IN}(\text{MAX})} - V_{\text{OUT}(\text{MIN})})I_{\text{LOAD}(\text{MAX})} \\ &= [(3.0 \times 1.1) - (2.7 \times .98)]98 \times 10^{-3} \\ &= 64 \text{ mW} \end{aligned}$$

Maximum allowable power dissipation:

$$P_{\text{D}(\text{MAX})} = \frac{(T_{\text{J}(\text{MAX})} - T_{\text{A}(\text{MAX})})}{\theta_{\text{JA}}}$$

$$= \frac{(125 - 55)}{220}$$

$$= 318 \text{ mW}$$

In this example, the TC56 dissipates a maximum of only 64 mW—far below the allowable limit of 318 mW. In a similar manner, Equation 1 and Equation 2 can be used to calculate maximum current and/or input voltage limits.

Layout Considerations

The primary path of heat conduction out of the package is via the package leads. Therefore, layouts having a ground plane, wide traces at the pads, and wide power supply bus lines combine to lower θ_{JA} and, therefore, increase the maximum allowable power dissipation limit.

TC56

TYPICAL CHARACTERISTICS

1. OUTPUT VOLTAGE vs. OUTPUT CURRENT

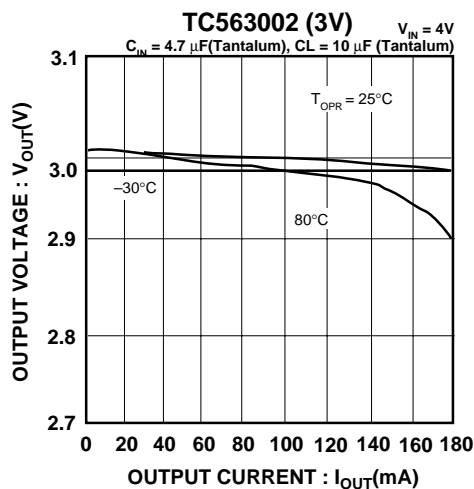
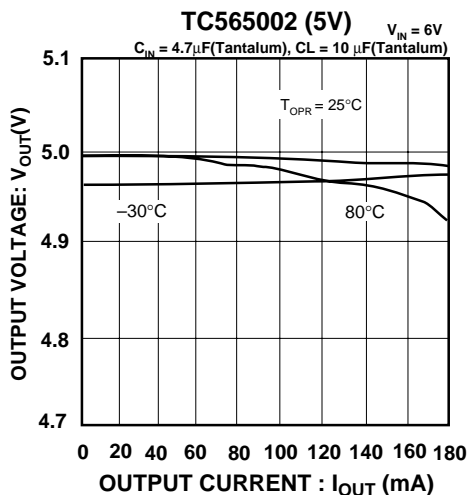

2. OUTPUT VOLTAGE vs. INPUT VOLTAGE

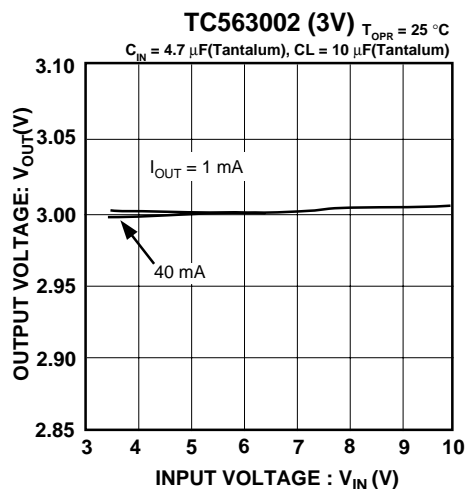
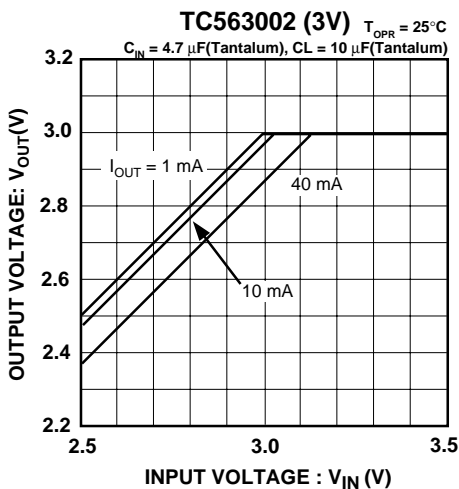
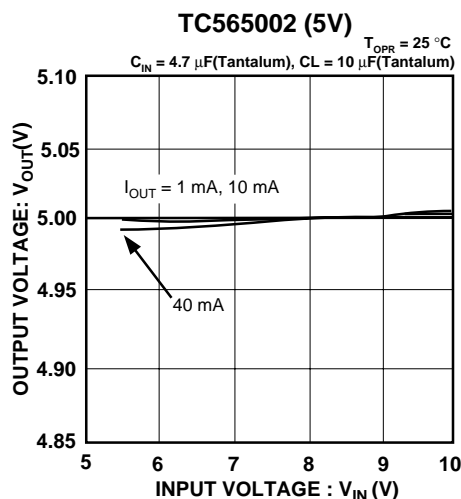
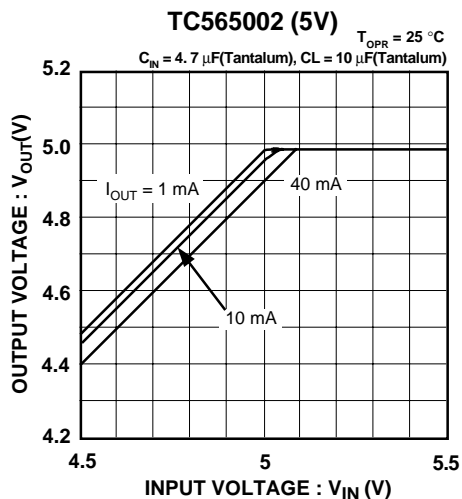

TYPICAL CHARACTERISTICS

3. INPUT/OUTPUT VOLTAGE DIFFERENTIAL vs. OUTPUT CURRENT

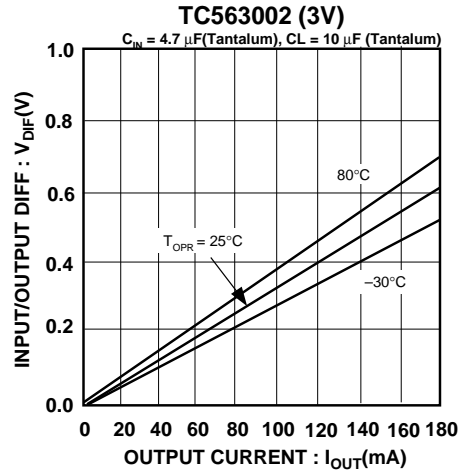
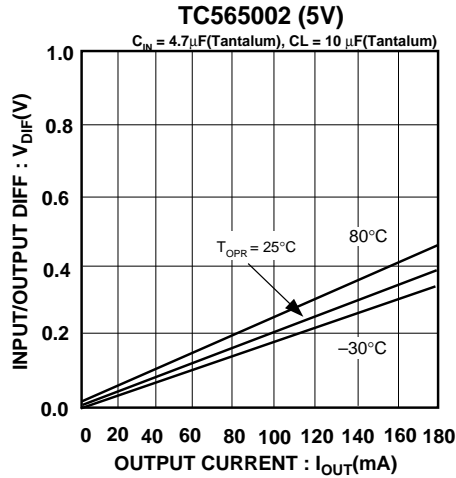

4. SHDN PIN THRESHOLD VOLTAGE vs. INPUT VOLTAGE

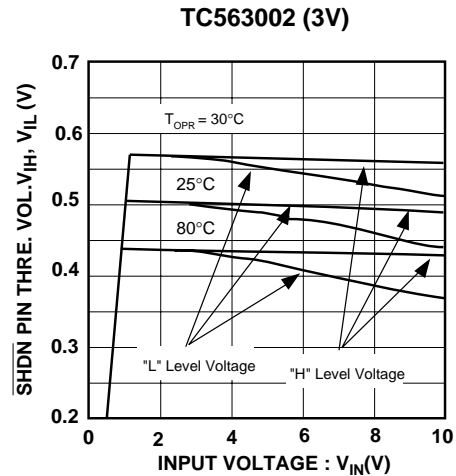
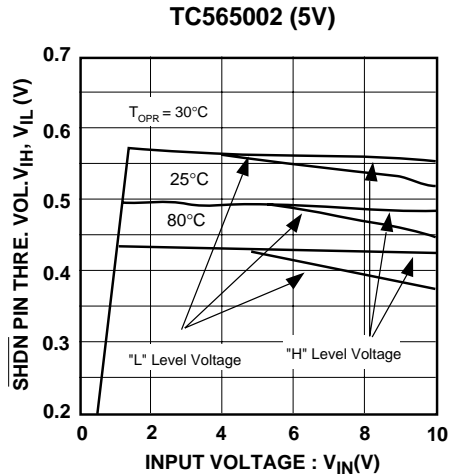

5. SUPPLY CURRENT vs. INPUT VOLTAGE

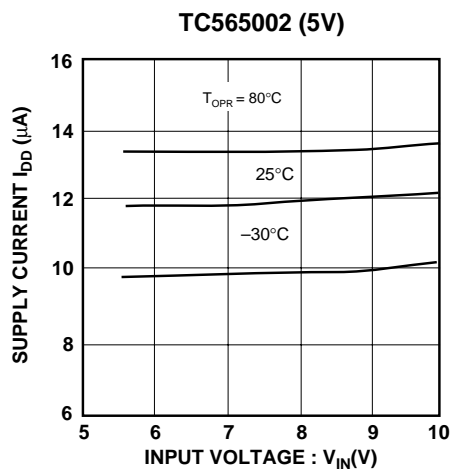
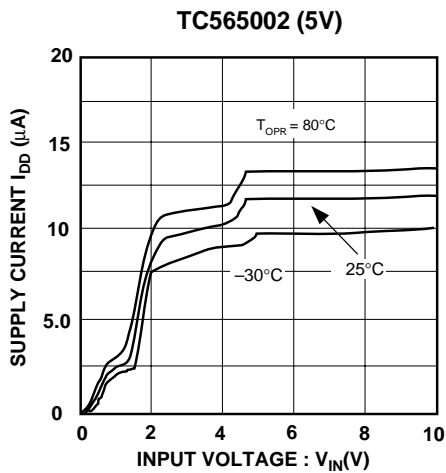

TC56

TYPICAL CHARACTERISTICS (CONT.)

5. SUPPLY CURRENT vs. INPUT VOLTAGE (CONTINUED)

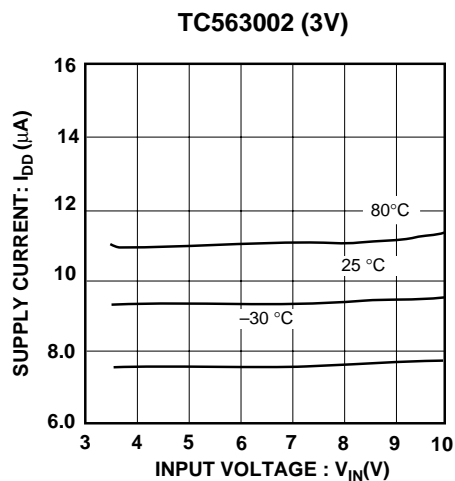
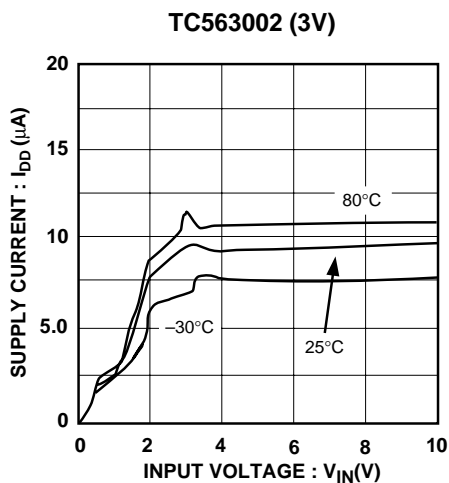

6. OUTPUT VOLTAGE vs. AMBIENT TEMPERATURE

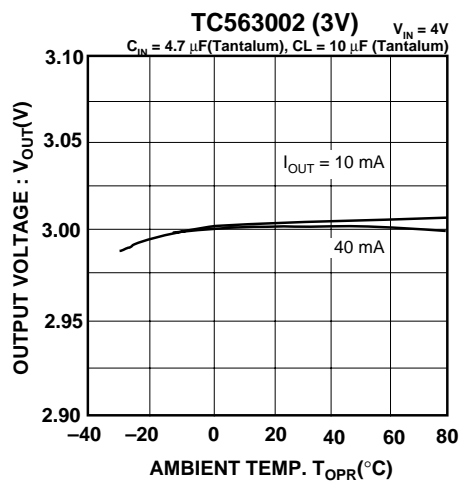
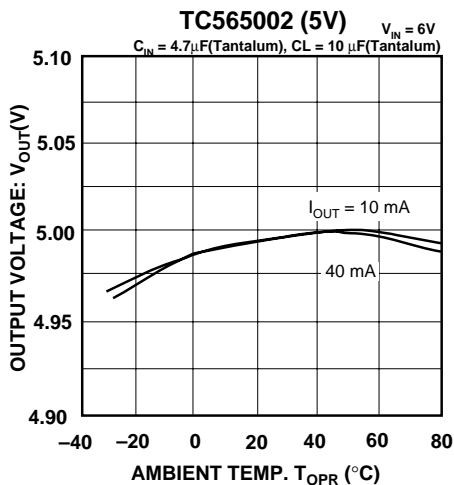

7. SUPPLY CURRENT vs. AMBIENT TEMPERATURE

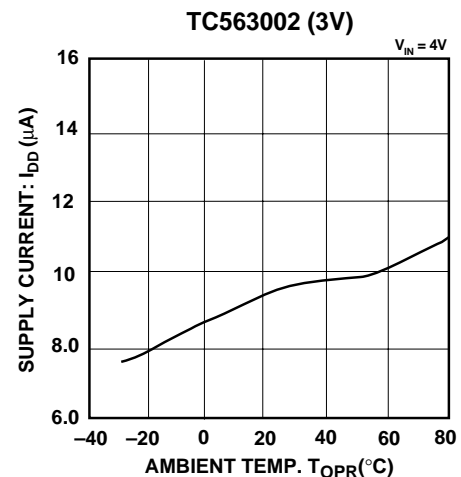
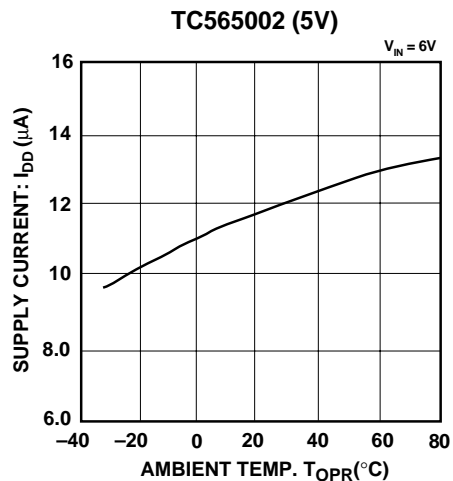

TYPICAL CHARACTERISTICS (CONT.)

8. INPUT TRANSIENT RESPONSE 1

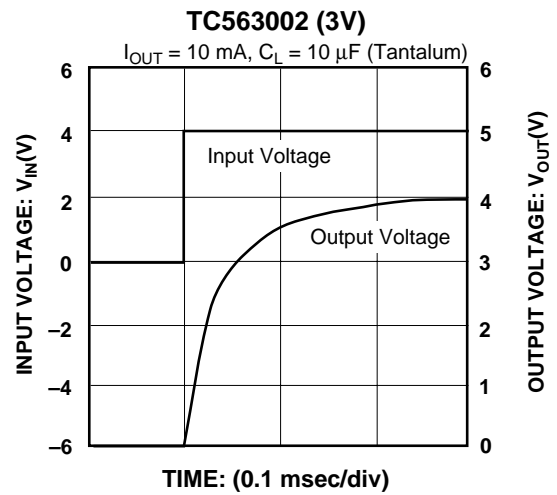
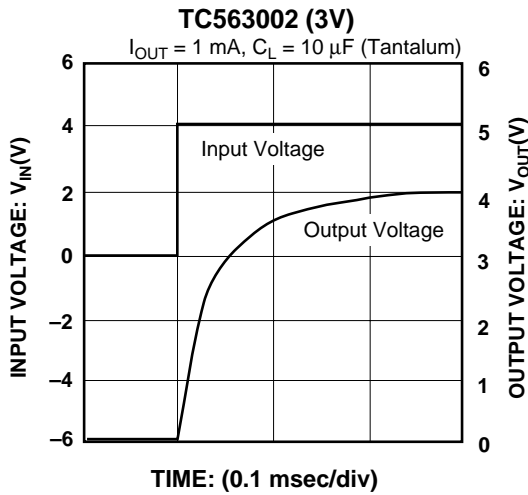
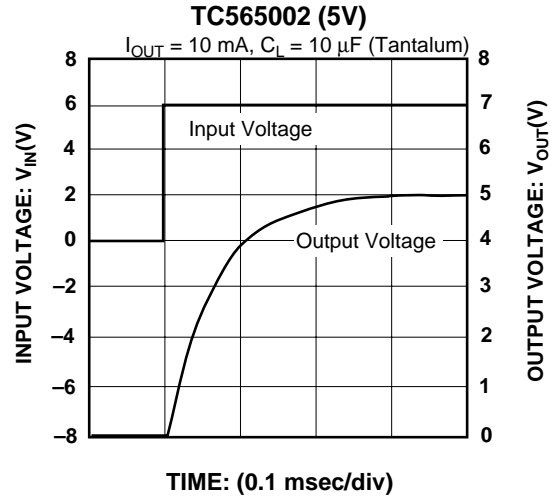
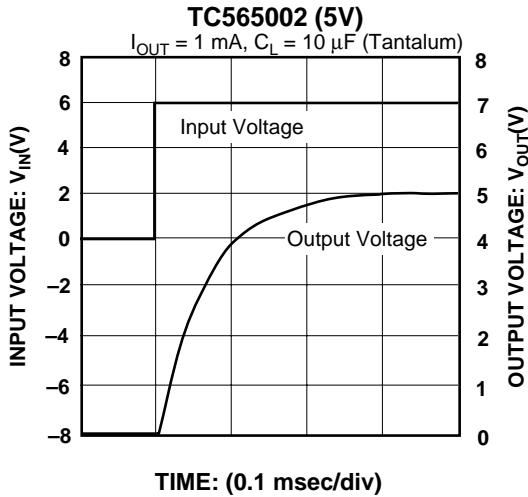

9. INPUT TRANSIENT RESPONSE 2

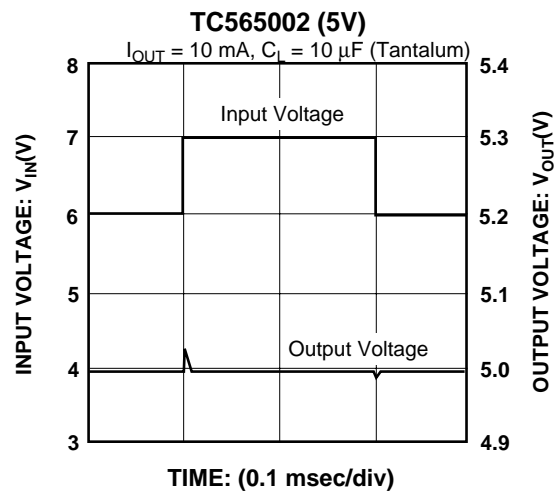
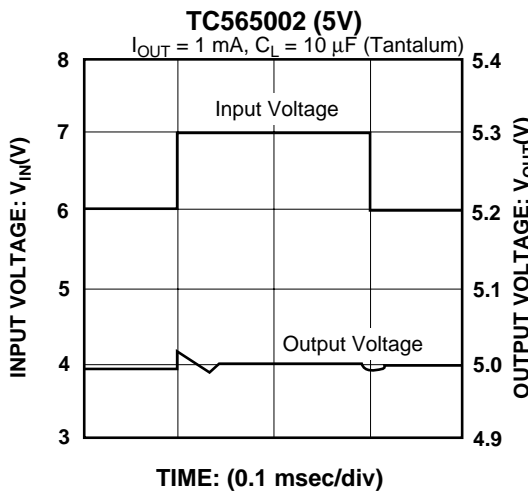

TC56

TYPICAL CHARACTERISTICS (CONT.)

9. INPUT TRANSIENT RESPONSE 2 (CONTINUED)

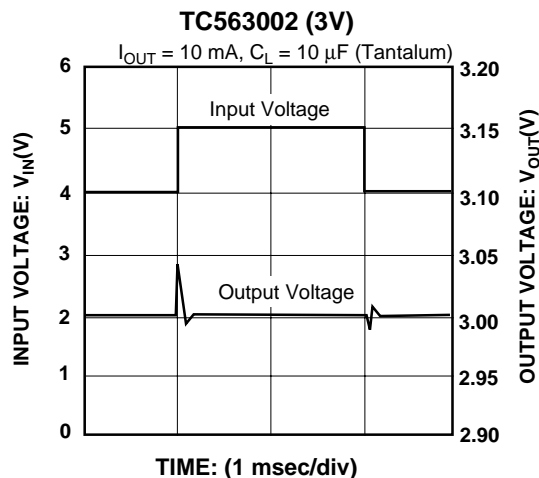
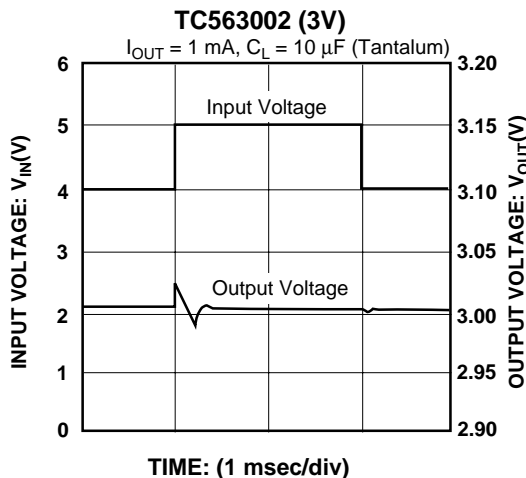

10. LOAD TRANSIENT RESPONSE

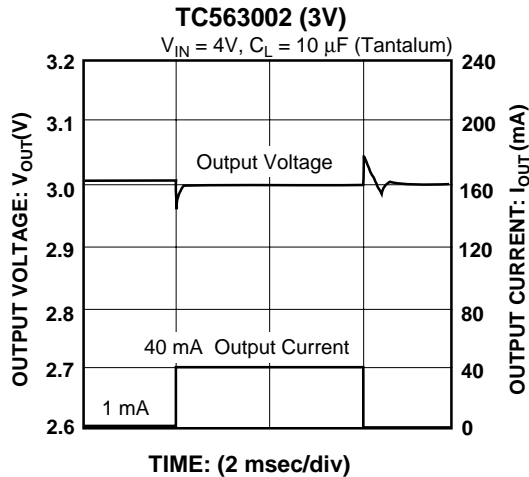
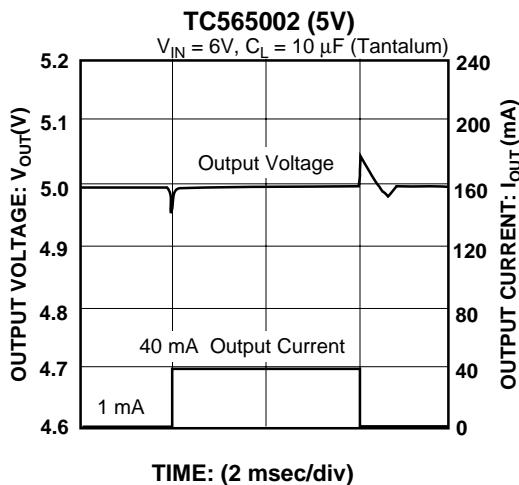

11. SHDN PIN TRANSIENT RESPONSE

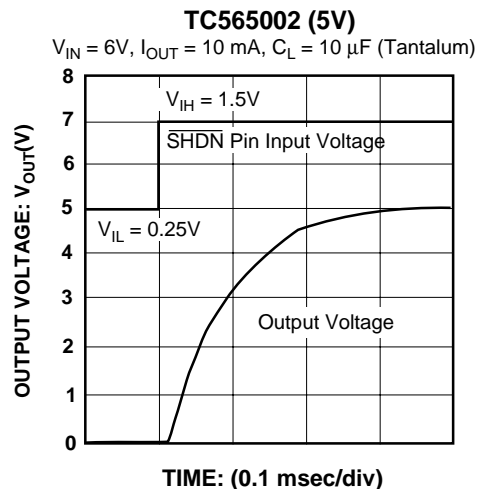
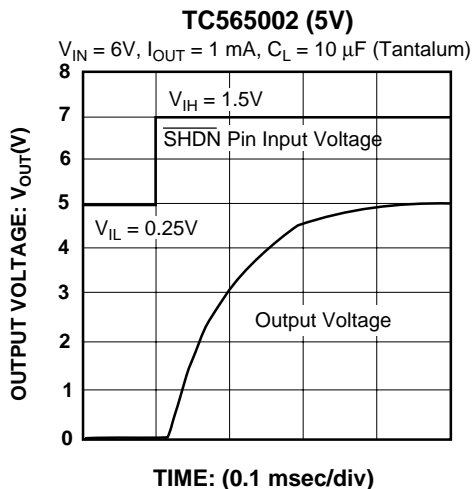

TYPICAL CHARACTERISTICS (CONT.)

11. SHDN PIN TRANSIENT RESPONSE (CONTINUED)

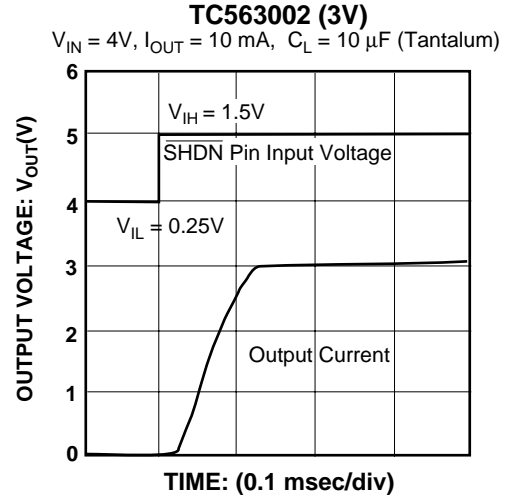
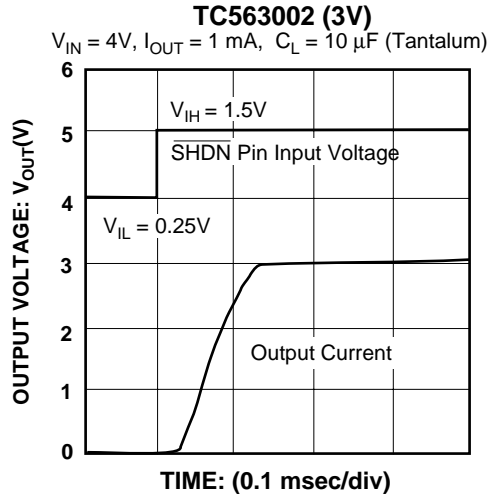

12. RIPPLE REJECTION RATE

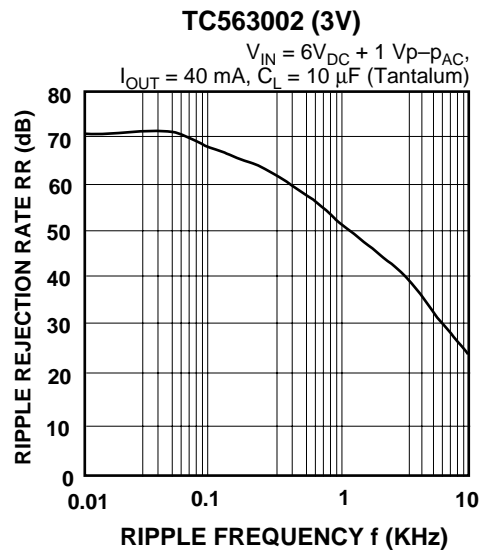
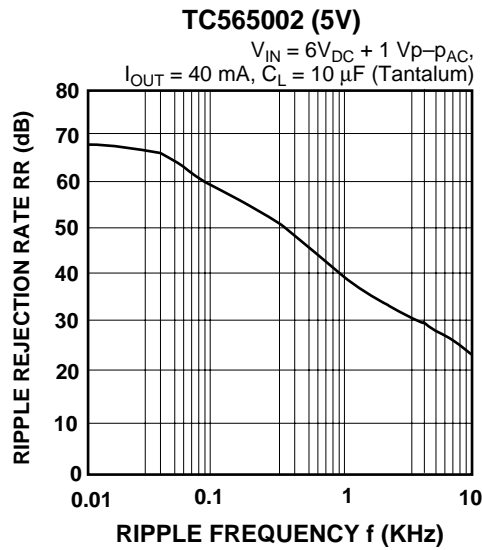

TC56

MARKINGS

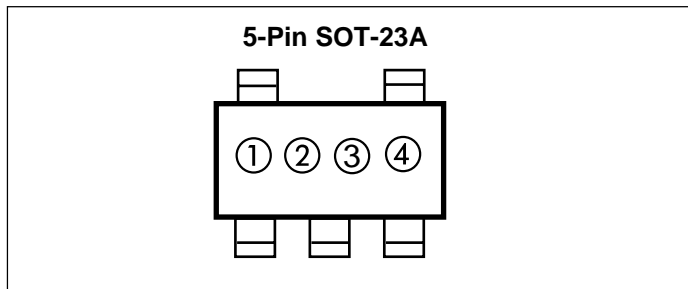

① represents the the interger of the output voltage

Symbol	Voltage
A	0.
B	1.
C	2.
D	3.
E	4.
F	5.
H	6.

② represents the interger of the output voltage

Symbol	Voltage	Symbol	Voltage
A	.0	F	.5
B	.1	H	.6
C	.2	K	.7
D	.3	L	.8
E	.4	M	.9

③ represents the transition response

Symbol	
-	REGULAR

④ represents assembly lot code

PACKAGE DIMENSIONS

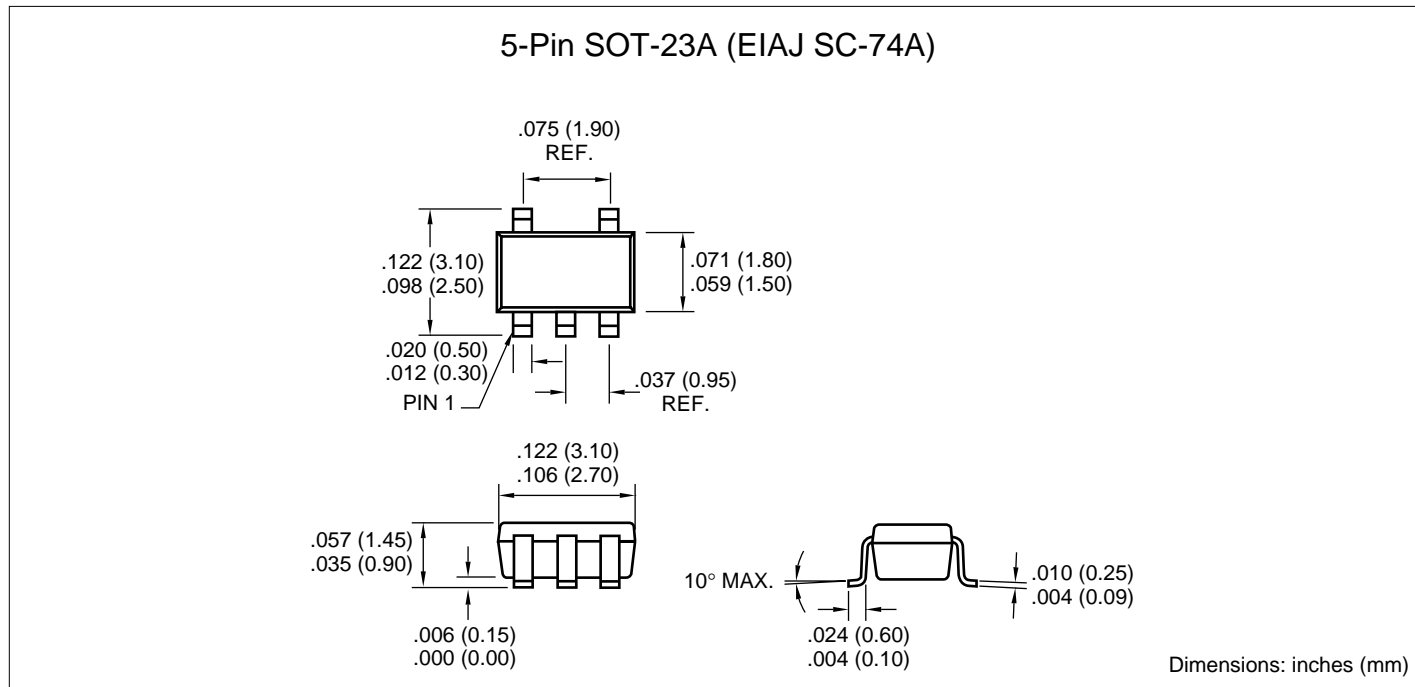



WORLDWIDE SALES AND SERVICE

AMERICAS

Corporate Office

2355 West Chandler Blvd.
Chandler, AZ 85224-6199
Tel: 480-792-7200 Fax: 480-792-7277
Technical Support: 480-792-7627
Web Address: <http://www.microchip.com>

Rocky Mountain

2355 West Chandler Blvd.
Chandler, AZ 85224-6199
Tel: 480-792-7966 Fax: 480-792-7456

Atlanta

500 Sugar Mill Road, Suite 200B
Atlanta, GA 30350
Tel: 770-640-0034 Fax: 770-640-0307

Austin

Analog Product Sales
8303 MoPac Expressway North
Suite A-201
Austin, TX 78759
Tel: 512-345-2030 Fax: 512-345-6085

Boston

2 Lan Drive, Suite 120
Westford, MA 01886
Tel: 978-692-3848 Fax: 978-692-3821

Boston

Analog Product Sales
Unit A-8-1 Millbrook Tarry Condominium
97 Lowell Road
Concord, MA 01742
Tel: 978-371-6400 Fax: 978-371-0050

Chicago

333 Pierce Road, Suite 180
Itasca, IL 60143
Tel: 630-285-0071 Fax: 630-285-0075

Dallas

4570 Westgrove Drive, Suite 160
Addison, TX 75001
Tel: 972-818-7423 Fax: 972-818-2924

Dayton

Two Prestige Place, Suite 130
Miamisburg, OH 45342
Tel: 937-291-1654 Fax: 937-291-9175

Detroit

Tri-Atria Office Building
32255 Northwestern Highway, Suite 190
Farmington Hills, MI 48334
Tel: 248-538-2250 Fax: 248-538-2260

Los Angeles

18201 Von Karman, Suite 1090
Irvine, CA 92612
Tel: 949-263-1888 Fax: 949-263-1338

Mountain View

Analog Product Sales
1300 Terra Bella Avenue
Mountain View, CA 94043-1836
Tel: 650-968-9241 Fax: 650-967-1590

New York

150 Motor Parkway, Suite 202
Hauppauge, NY 11788
Tel: 631-273-5305 Fax: 631-273-5335

San Jose

Microchip Technology Inc.
2107 North First Street, Suite 590
San Jose, CA 95131
Tel: 408-436-7950 Fax: 408-436-7955

Toronto

6285 Northam Drive, Suite 108
Mississauga, Ontario L4V 1X5, Canada
Tel: 905-673-0699 Fax: 905-673-6509

ASIA/PACIFIC

China - Beijing

Microchip Technology Beijing Office
Unit 915
New China Hong Kong Manhattan Bldg.
No. 6 Chaoyangmen Beidajie
Beijing, 100027, No. China
Tel: 86-10-85282100 Fax: 86-10-85282104

China - Shanghai

Microchip Technology Shanghai Office
Room 701, Bldg. B
Far East International Plaza
No. 317 Xian Xia Road
Shanghai, 200051
Tel: 86-21-6275-5700 Fax: 86-21-6275-5060

Hong Kong

Microchip Asia Pacific
RM 2101, Tower 2, Metroplaza
223 Hing Fong Road
Kwai Fong, N.T., Hong Kong
Tel: 852-2401-1200 Fax: 852-2401-3431

India

Microchip Technology Inc.
India Liaison Office
Divyasree Chambers
1 Floor, Wing A (A3/A4)
No. 11, OIShaughnessey Road
Bangalore, 560 025, India
Tel: 91-80-2290061 Fax: 91-80-2290062

Japan

Microchip Technology Intl. Inc.
Benex S-1 6F
3-18-20, Shinyokohama
Kohoku-Ku, Yokohama-shi
Kanagawa, 222-0033, Japan
Tel: 81-45-471- 6166 Fax: 81-45-471-6122

Korea

Microchip Technology Korea
168-1, Youngbo Bldg. 3 Floor
Samsung-Dong, Kangnam-Ku
Seoul, Korea
Tel: 82-2-554-7200 Fax: 82-2-558-5934

ASIA/PACIFIC (continued)

Singapore

Microchip Technology Singapore Pte Ltd.
200 Middle Road
#07-02 Prime Centre
Singapore, 188980
Tel: 65-334-8870 Fax: 65-334-8850

Taiwan

Microchip Technology Taiwan
11F-3, No. 207
Tung Hua North Road
Taipei, 105, Taiwan
Tel: 886-2-2717-7175 Fax: 886-2-2545-0139

EUROPE

Australia

Microchip Technology Australia Pty Ltd
Suite 22, 41 Rawson Street
Epping 2121, NSW
Australia
Tel: 61-2-9868-6733 Fax: 61-2-9868-6755

Denmark

Microchip Technology Denmark ApS
Regus Business Centre
Lautrup høj 1-3
Ballerup DK-2750 Denmark
Tel: 45 4420 9895 Fax: 45 4420 9910

France

Arizona Microchip Technology SARL
Parc d'Activite du Moulin de Massy
43 Rue du Saule Trapu
Batiment A - 1er Etage
91300 Massy, France
Tel: 33-1-69-53-63-20 Fax: 33-1-69-30-90-79

Germany

Arizona Microchip Technology GmbH
Gustav-Heinemann Ring 125
D-81739 Munich, Germany
Tel: 49-89-627-144 0 Fax: 49-89-627-144-44

Germany

Analog Product Sales
Lochhamer Strasse 13
D-82152 Martinsried, Germany
Tel: 49-89-895650-0 Fax: 49-89-895650-22

Italy

Arizona Microchip Technology SRL
Centro Direzionale Colleoni
Palazzo Taurus 1 V. Le Colleoni 1
20041 Agrate Brianza
Milan, Italy
Tel: 39-039-65791-1 Fax: 39-039-6899883

United Kingdom

Arizona Microchip Technology Ltd.
505 Eskdale Road
Winnersh Triangle
Wokingham
Berkshire, England RG41 5TU
Tel: 44 118 921 5869 Fax: 44-118 921-5820

All rights reserved. © 2001 Microchip Technology Incorporated. Printed in the USA. 1/01  Printed on recycled paper.

01/09/01

Information contained in this publication regarding device applications and the like is intended through suggestion only and may be superseded by updates. It is your responsibility to ensure that your application meets with your specifications. No representation or warranty is given and no liability is assumed by Microchip Technology Incorporated with respect to the accuracy or use of such information, or infringement of patents or other intellectual property rights arising from such use or otherwise. Use of Microchip's products as critical components in life support systems is not authorized except with express written approval by Microchip. No licenses are conveyed, implicitly or otherwise, except as maybe explicitly expressed herein, under any intellectual property rights. The Microchip logo and name are registered trademarks of Microchip Technology Inc. in the U.S.A. and other countries. All rights reserved. All other trademarks mentioned herein are the property of their respective companies.