

800mA Fixed Output CMOS LDO

FEATURES

- Very Low Dropout Voltage
- Guaranteed 800mA Output
- High Output Voltage Accuracy
- Standard or Custom Output Voltages
- Over-Current and Over-Temperature Protection

APPLICATIONS

- Battery-Operated Systems
- Portable Computers
- Medical Instruments
- Instrumentation
- Cellular / GSM / PHS Phones
- Linear Post-Regulator for SMPS
- Pagers

GENERAL DESCRIPTION

The TC1264 is a fixed output, high accuracy (typically $\pm 0.5\%$) CMOS low dropout regulator. Designed specifically for battery-operated systems, the TC1264's CMOS construction eliminates wasted ground current, significantly extending battery life. Total supply current is typically 80 μA at full load (*20 to 60 times lower than in bipolar regulators!*).

TC1264 key features include ultra low noise, very low dropout voltage (typically 450mV at full load), and fast response to step changes in load. The TC1264 incorporates both over-temperature and over-current protection. The TC1264 is stable with an output capacitor of only 1 μF and has a maximum output current of 800mA. It is available in 3-Pin SOT-223, 3-Pin TO-220, and 3-Pin DDPAK packages.

TYPICAL APPLICATION

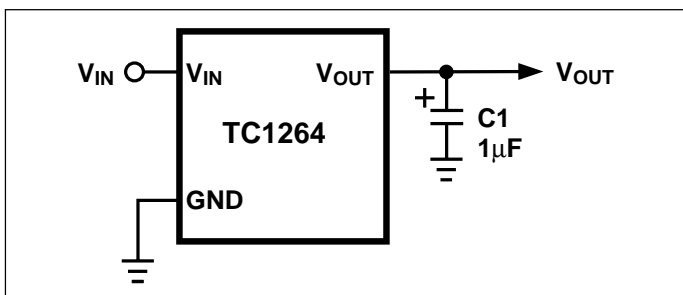

PIN CONFIGURATION

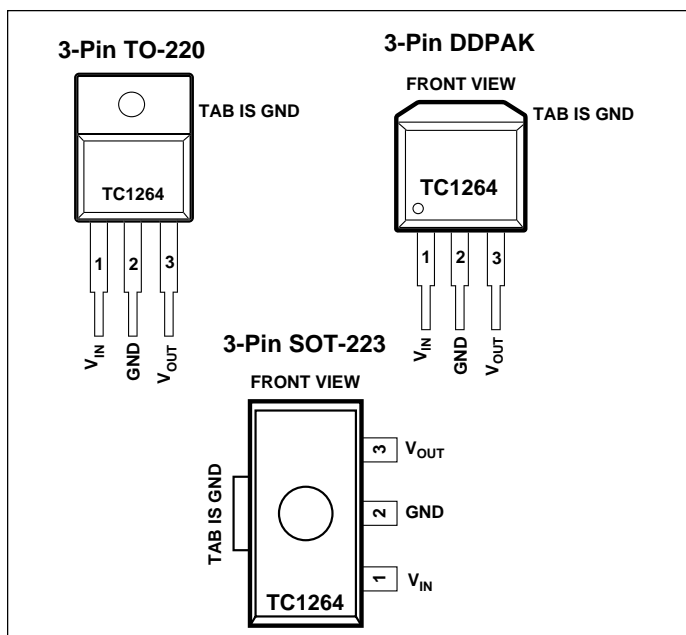

ORDERING INFORMATION

Part Number	Package	Junction Temperature Range
TC1264-xxVDB	3-Pin SOT-223	-40°C to +125°C
TC1264-xxVAB	3-Pin TO-220	-40°C to +125°C
TC1264-xxVEB	3-Pin DDPAK	-40°C to +125°C

Available Output Voltages:

1.8, 2.5, 3.0, 3.3

xx indicates output voltages

Other output voltages are available. Please contact Microchip Technology Inc. for details.

TC1264

ABSOLUTE MAXIMUM RATINGS*

Input Voltage 6.5V
 Output Voltage ($V_{SS} - 0.3$) to ($V_{IN} + 0.3$)
 Power Dissipation Internally Limited (Note 8)
 Operating Temperature $-40^{\circ}\text{C} < T_J < 125^{\circ}\text{C}$
 Storage Temperature -65°C to $+150^{\circ}\text{C}$

Maximum Voltage on Any Pin $V_{IN} + 0.3\text{V}$ to -0.3V
 Lead Temperature (Soldering, 10 Sec.) $+260^{\circ}\text{C}$

*Absolute Maximum Ratings indicate device operation limits beyond damage may occur. Device operation beyond the limits listed in Electrical Characteristics is not recommended.

ELECTRICAL CHARACTERISTICS: $V_{IN} = V_R + 1.5\text{V}$ (Note 1), $I_L = 100\mu\text{A}$, $C_L = 3.3\mu\text{F}$, $T_A = 25^{\circ}\text{C}$, unless otherwise specified. **BOLDFACE** type specifications apply for junction temperatures of -40°C to $+125^{\circ}\text{C}$.

Symbol	Parameter	Test Conditions	Min	Typ	Max	Units
V_{IN}	Input Operating Voltage	(Note 2)	2.7	—	6.0	V
I_{OUTMAX}	Maximum Output Current		800	—	—	mA
V_{OUT}	Output Voltage	$V_R \geq 2.5\text{V}$ $V_R = 1.8\text{V}$	$V_R - 2.5\%$ $V_R - 2\%$	$V_R \pm 0.5\%$ $V_R \pm 0.5\%$	$V_R + 2.5\%$ $V_R + 3\%$	V
		$I_L = 0.1\text{mA}$ to 800mA (Note 3)	$V_R - 7\%$	—	$V_R + 3\%$	V
$\Delta V_{OUT}/\Delta T$	V_{OUT} Temperature Coefficient	Note 4	—	40	—	ppm/ $^{\circ}\text{C}$
$\Delta V_{OUT}/\Delta V_{IN}$	Line Regulation	$(V_R + 1\text{V}) \leq V_{IN} \leq 6\text{V}$	—	0.007	0.35	%
$\Delta V_{OUT}/V_{OUT}$	Load Regulation	$I_L = 0.1\text{mA}$ to I_{OUTMAX} (Note 5)	-0.01	0.002	0	%/mA
$V_{IN} - V_{OUT}$	Dropout Voltage	$V_R \geq 2.5\text{V}$, $I_L = 100\mu\text{A}$	—	20	30	mV
		$I_L = 100\text{mA}$	—	50	160	
		$I_L = 300\text{mA}$	—	150	480	
		$I_L = 500\text{mA}$	—	260	800	
		$I_L = 800\text{mA}$	—	450	1300	
		$V_R = 1.8\text{V}$, $I_L = 500\text{mA}$ $I_L = 800\text{mA}$	—	700 890	1000 1400	
I_{DD}	Supply Current	$I_L = 0$	—	80	130	μA
PSRR	Power Supply Rejection Ratio	$F \leq 1\text{kHz}$	—	64	—	dB
I_{OUTSC}	Output Short Circuit Current	$V_{OUT} = 0\text{V}$	—	1200	—	mA
$\Delta V_{OUT}/\Delta P_D$	Thermal Regulation	Note 7	—	0.04	—	V/W
eN	Output Noise	$I_L = I_{OUTMAX}$, $F = 10\text{kHz}$	—	260	—	nV/ $\sqrt{\text{Hz}}$

- NOTES:**
- V_R is the regulator output voltage setting.
 - The minimum V_{IN} has to justify the conditions: $V_{IN} \geq V_R + V_{DROPOUT}$ and $V_{IN} \geq 2.7\text{V}$ for $I_L = 0.1\text{mA}$ to I_{OUTMAX} .
 - This accuracy represents the worst case over the entire output current and temperature range.
 - $T_C V_{OUT} = \frac{(V_{OUTMAX} - V_{OUTMIN}) \times 10^6}{V_{OUT} \times \Delta T}$
 - Regulation is measured at a constant junction temperature using low duty cycle pulse testing. Load regulation is tested over a load range from 0.1mA to the maximum specified output current. Changes in output voltage due to heating effects are covered by the thermal regulation specification.
 - Dropout voltage is defined as the input to output differential at which the output voltage drops 2% below its nominal value measured at a 1.5V differential.
 - Thermal Regulation is defined as the change in output voltage at a time T after a change in power dissipation is applied, excluding load or line regulation effects. Specifications are for a current pulse equal to I_{LMAX} at $V_{IN} = 6\text{V}$ for $T = 10$ msec.
 - The maximum allowable power dissipation is a function of ambient temperature, the maximum allowable junction temperature, and the thermal resistance from junction-to-air (i.e. T_A , T_J , θ_{JA}). Exceeding the maximum allowable power dissipation causes the device to initiate thermal shutdown. Please see *Thermal Considerations* section of this data sheet for more details.

DETAILED DESCRIPTION

The TC1264 is a precision, fixed output LDO. Unlike bipolar regulators, the TC1264 supply current does not increase with load current. In addition, V_{OUT} remains stable and within regulation at very low load currents (an important consideration in RTC and CMOS RAM battery backup applications). Figure 1 shows a typical application circuit.

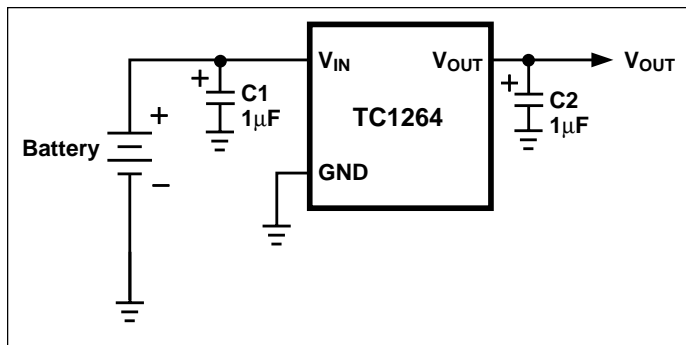

Figure 1: Typical Application Circuit

Output Capacitor

A 1µF (min) capacitor from V_{OUT} to ground is required. The output capacitor should have an effective series resistance of 5Ω or less. A 1µF capacitor should be connected from V_{IN} to GND if there is more than 10 inches of wire between the regulator and the AC filter capacitor, or if a battery is used as the power source. Aluminum electrolytic or tantalum capacitor types can be used. (Since many aluminum electrolytic capacitors freeze at approximately -30°C, solid tantalums are recommended for applications operating below -25°C.) When operating from sources other than batteries, supply-noise rejection and transient response can be improved by increasing the value of the input and output capacitors and employing passive filtering techniques.

Thermal Considerations

Thermal Shutdown

Integrated thermal protection circuitry shuts the regulator off when die temperature exceeds 160°C. The regulator remains off until the die temperature drops to approximately 150°C.

Power Dissipation

The amount of power the regulator dissipates is primarily a function of input and output voltage, and output current. The following equation is used to calculate worst case *actual* power dissipation:

$$P_D \approx (V_{INMAX} - V_{OUTMIN})I_{LOADMAX}$$

Where: P_D = worst case actual power dissipation
 V_{INMAX} = maximum voltage on V_{IN}
 V_{OUTMIN} = minimum regulator output voltage
 $I_{LOADMAX}$ = maximum output (load) current

Equation 1.

The maximum *allowable* power dissipation (Equation 2) is a function of the maximum ambient temperature (T_{AMAX}), the maximum allowable die temperature (125°C) and the thermal resistance from junction-to-air (θ_{JA}).

$$P_{DMAX} = \frac{(T_{JMAX} - T_{AMAX})}{\theta_{JA}}$$

Where all terms are previously defined.

Equation 2.

Table 1 shows various values of θ_{JA} for the TC1264 mounted on a 1/16 inch, 2-layer PCB with 1 oz. copper foil.

Table 1. Thermal Resistance Guidelines for TC1264 in 3-Pin SOT-223 Package

Copper Area (Topside)*	Copper Area (Backside)	Board Area	Thermal Resistance (θ_{JA})
2500 sq mm	2500 sq mm	2500 sq mm	45°C/W
1000 sq mm	2500 sq mm	2500 sq mm	45°C/W
225 sq mm	2500 sq mm	2500 sq mm	53°C/W
100 sq mm	2500 sq mm	2500 sq mm	59°C/W
1000 sq mm	1000 sq mm	1000 sq mm	52°C/W
1000 sq mm	0 sq mm	1000 sq mm	55°C/W

NOTES: *Tab of device attached to topside copper

Table 2. Thermal Resistance Guidelines for TC1264 in 3-Pin DPAK/TO-220 Package

Copper Area (Topside)*	Copper Area (Backside)	Board Area	Thermal Resistance (θ_{JA})
2500 sq mm	2500 sq mm	2500 sq mm	25°C/W
1000 sq mm	2500 sq mm	2500 sq mm	27°C/W
125 sq mm	2500 sq mm	2500 sq mm	35°C/W

NOTES: *Tab of device attached to topside copper

TC1264

Equation 1 can be used in conjunction with Equation 2 to ensure regulator thermal operation is within limits. For example:

GIVEN: $V_{INMAX} = 3.3V \pm 10\%$
 $V_{OUTMIN} = 2.7V \pm 0.5\%$
 $I_{LOADMAX} = 275mA$
 $T_{JMAX} = 125^{\circ}C$
 $T_{AMAX} = 95^{\circ}C$
 $\theta_{JA} = 59^{\circ}C/W$ (SOT-223)

FIND: 1. Actual power dissipation
 2. Maximum allowable dissipation

Actual power dissipation:

$$P_D \approx (V_{INMAX} - V_{OUTMIN})I_{LOADMAX}$$

$$= [(3.3 \times 1.1) - (2.7 \times .995)]275 \times 10^{-3}$$

$$= \underline{260mW}$$

Maximum allowable power dissipation:

$$P_{DMAX} = \frac{(T_{JMAX} - T_{AMAX})}{\theta_{JA}}$$

$$= \frac{(125 - 95)}{59}$$

$$= \underline{508mW}$$

In this example, the TC1264 dissipates a maximum of only 260mW; far below the allowable limit of 508mW. In a similar manner, Equation 1 and Equation 2 can be used to calculate maximum current and/or input voltage limits. For example, the maximum allowable V_{IN} is found by substituting the maximum allowable power dissipation of 508mW into Equation 1, from which $V_{INMAX} = 4.6V$.

TYPICAL CHARACTERISTICS

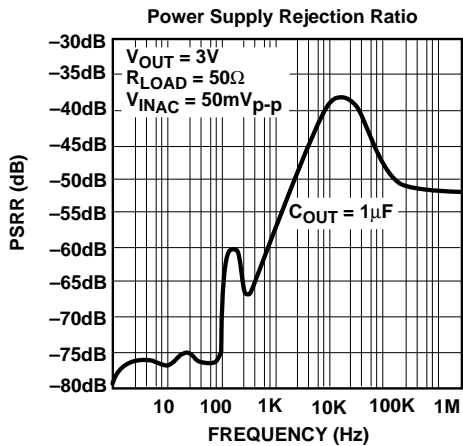
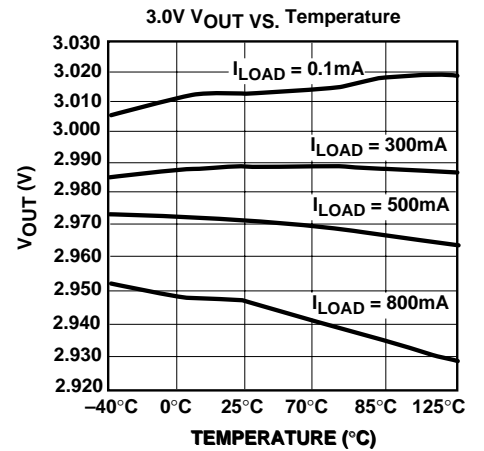
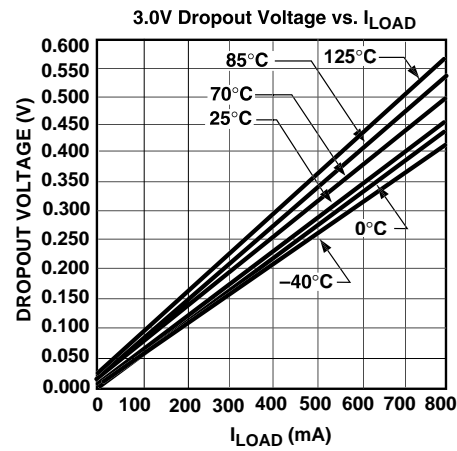
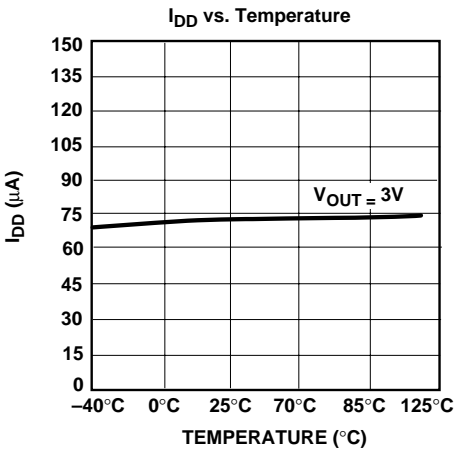
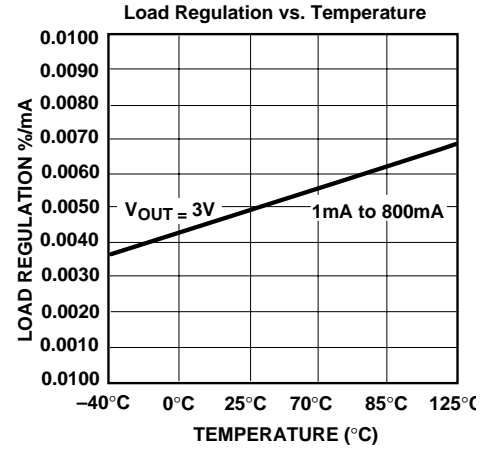
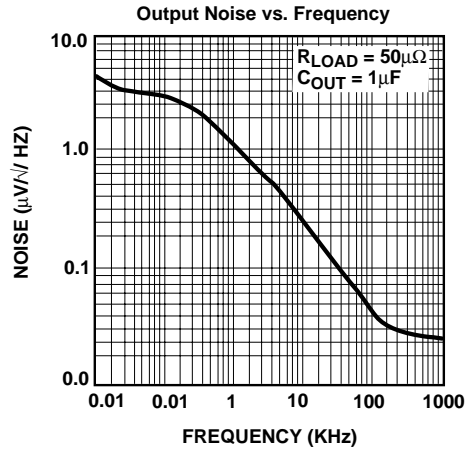
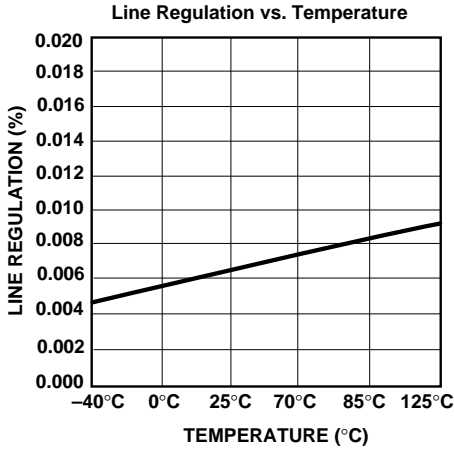

TC1264

TAPING FORMS

Component Taping Orientation for 3-Pin SOT-223 Devices

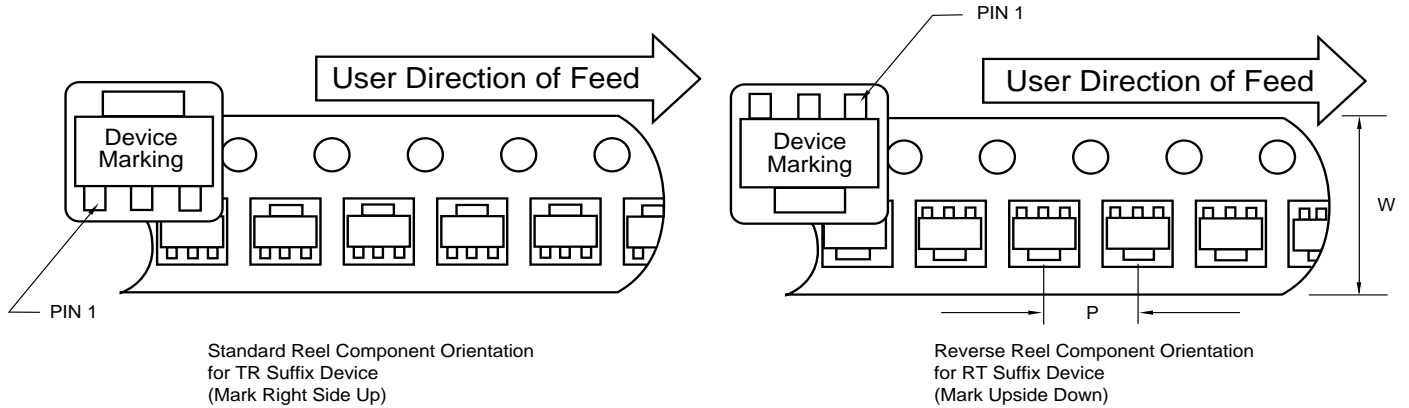

Carrier Tape, Number of Components Per Reel and Reel Size

Package	Carrier Width (W)	Pitch (P)	Part Per Full Reel	Reel Size
3-Pin SOT-223	12 mm	8 mm	4000	13 in

Component Taping Orientation for 3-Pin DDPAK Devices

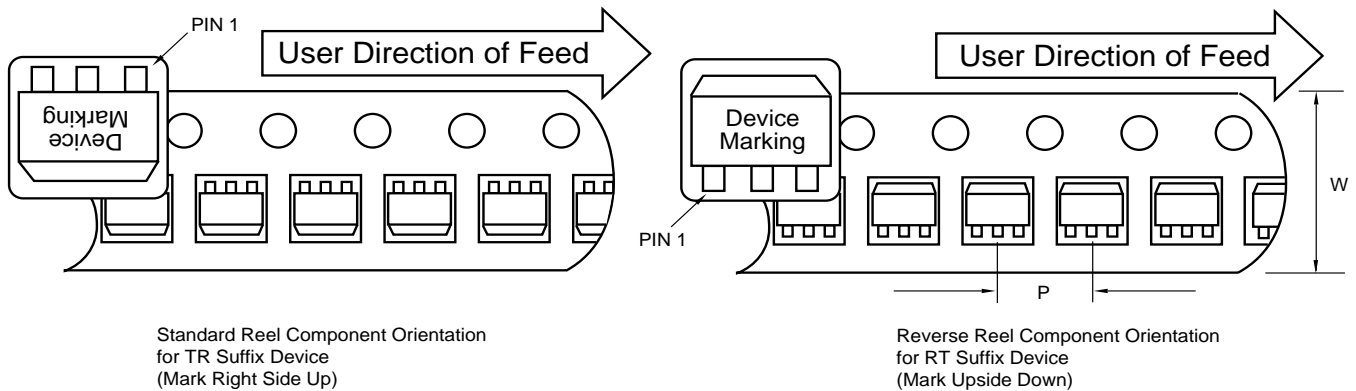

Carrier Tape, Number of Components Per Reel and Reel Size

Package	Carrier Width (W)	Pitch (P)	Part Per Full Reel	Reel Size
3-Pin DDPAK	24 mm	16 mm	750	13 in

PACKAGE DIMENSIONS

3-Pin DDPAK

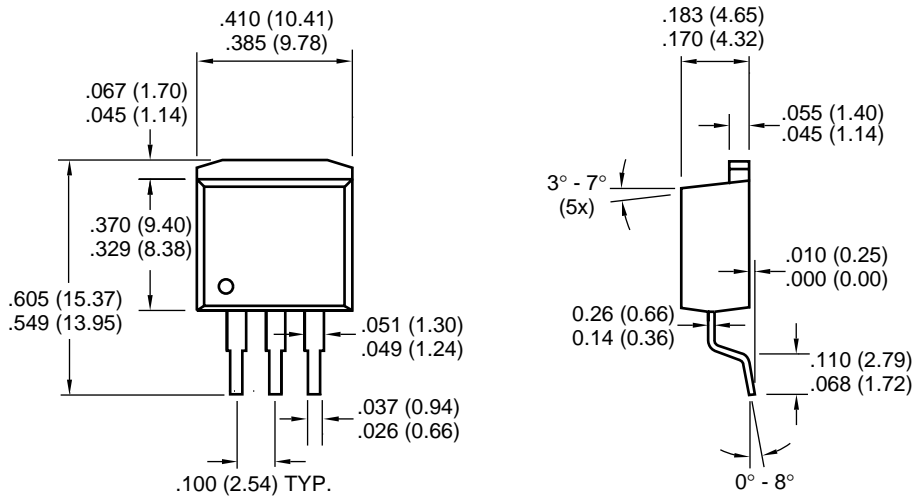

3-Pin TO-220

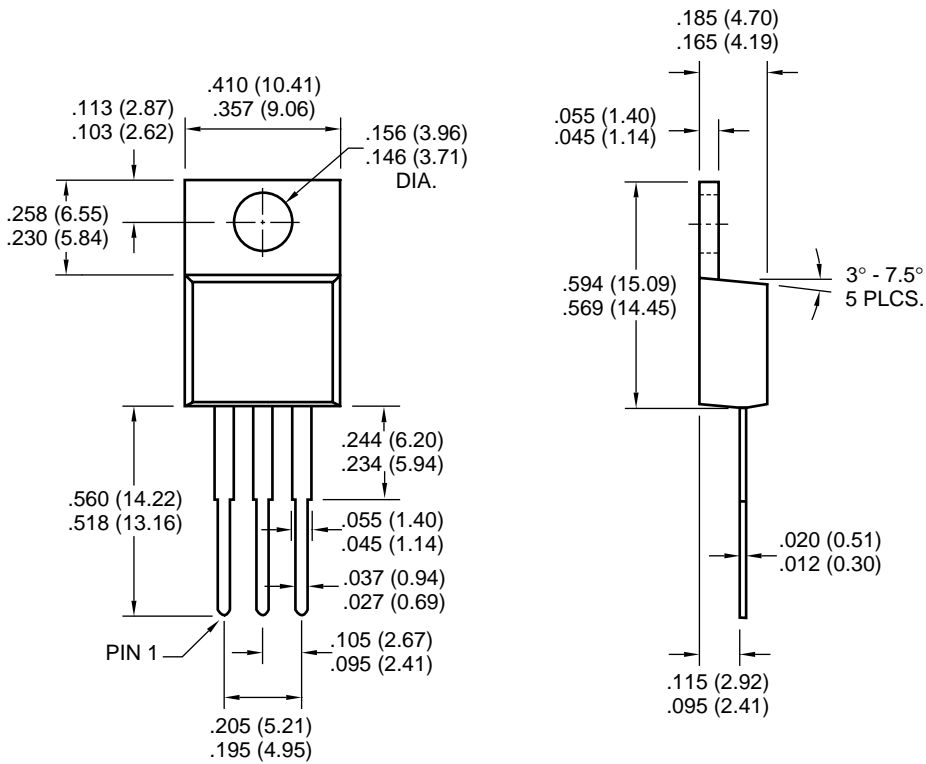

Dimensions: inches (mm)

TC1264

PACKAGE DIMENSIONS

3-Pin SOT-223

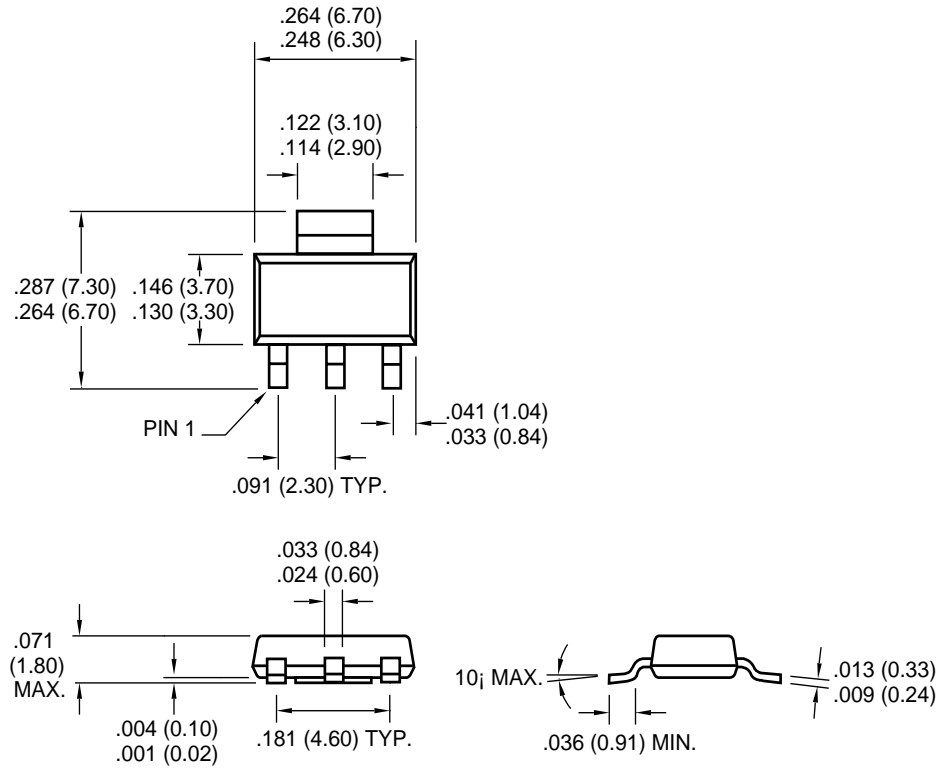

Dimensions: inches (mm)



WORLDWIDE SALES AND SERVICE

AMERICAS

Corporate Office

2355 West Chandler Blvd.
Chandler, AZ 85224-6199
Tel: 480-792-7200 Fax: 480-792-7277
Technical Support: 480-792-7627
Web Address: <http://www.microchip.com>

Rocky Mountain

2355 West Chandler Blvd.
Chandler, AZ 85224-6199
Tel: 480-792-7966 Fax: 480-792-7456

Atlanta

500 Sugar Mill Road, Suite 200B
Atlanta, GA 30350
Tel: 770-640-0034 Fax: 770-640-0307

Austin

Analog Product Sales
8303 MoPac Expressway North
Suite A-201
Austin, TX 78759
Tel: 512-345-2030 Fax: 512-345-6085

Boston

2 Lan Drive, Suite 120
Westford, MA 01886
Tel: 978-692-3848 Fax: 978-692-3821

Boston

Analog Product Sales
Unit A-8-1 Millbrook Tarry Condominium
97 Lowell Road
Concord, MA 01742
Tel: 978-371-6400 Fax: 978-371-0050

Chicago

333 Pierce Road, Suite 180
Itasca, IL 60143
Tel: 630-285-0071 Fax: 630-285-0075

Dallas

4570 Westgrove Drive, Suite 160
Addison, TX 75001
Tel: 972-818-7423 Fax: 972-818-2924

Dayton

Two Prestige Place, Suite 130
Miamisburg, OH 45342
Tel: 937-291-1654 Fax: 937-291-9175

Detroit

Tri-Atria Office Building
32255 Northwestern Highway, Suite 190
Farmington Hills, MI 48334
Tel: 248-538-2250 Fax: 248-538-2260

Los Angeles

18201 Von Karman, Suite 1090
Irvine, CA 92612
Tel: 949-263-1888 Fax: 949-263-1338

Mountain View

Analog Product Sales
1300 Terra Bella Avenue
Mountain View, CA 94043-1836
Tel: 650-968-9241 Fax: 650-967-1590

New York

150 Motor Parkway, Suite 202
Hauppauge, NY 11788
Tel: 631-273-5305 Fax: 631-273-5335

San Jose

Microchip Technology Inc.
2107 North First Street, Suite 590
San Jose, CA 95131
Tel: 408-436-7950 Fax: 408-436-7955

Toronto

6285 Northam Drive, Suite 108
Mississauga, Ontario L4V 1X5, Canada
Tel: 905-673-0699 Fax: 905-673-6509

ASIA/PACIFIC

China - Beijing

Microchip Technology Beijing Office
Unit 915
New China Hong Kong Manhattan Bldg.
No. 6 Chaoyangmen Beidajie
Beijing, 100027, No. China
Tel: 86-10-85282100 Fax: 86-10-85282104

China - Shanghai

Microchip Technology Shanghai Office
Room 701, Bldg. B
Far East International Plaza
No. 317 Xian Xia Road
Shanghai, 200051
Tel: 86-21-6275-5700 Fax: 86-21-6275-5060

Hong Kong

Microchip Asia Pacific
RM 2101, Tower 2, Metroplaza
223 Hing Fong Road
Kwai Fong, N.T., Hong Kong
Tel: 852-2401-1200 Fax: 852-2401-3431

India

Microchip Technology Inc.
India Liaison Office
Divyasree Chambers
1 Floor, Wing A (A3/A4)
No. 11, O'Shaughnessy Road
Bangalore, 560 025, India
Tel: 91-80-2290061 Fax: 91-80-2290062

Japan

Microchip Technology Intl. Inc.
Benex S-1 6F
3-18-20, Shinyokohama
Kohoku-Ku, Yokohama-shi
Kanagawa, 222-0033, Japan
Tel: 81-45-471- 6166 Fax: 81-45-471-6122

Korea

Microchip Technology Korea
168-1, Youngbo Bldg. 3 Floor
Samsung-Dong, Kangnam-Ku
Seoul, Korea
Tel: 82-2-554-7200 Fax: 82-2-558-5934

ASIA/PACIFIC (continued)

Singapore

Microchip Technology Singapore Pte Ltd.
200 Middle Road
#07-02 Prime Centre
Singapore, 188980
Tel: 65-334-8870 Fax: 65-334-8850

Taiwan

Microchip Technology Taiwan
11F-3, No. 207
Tung Hua North Road
Taipei, 105, Taiwan
Tel: 886-2-2717-7175 Fax: 886-2-2545-0139

EUROPE

Australia

Microchip Technology Australia Pty Ltd
Suite 22, 41 Rawson Street
Epping 2121, NSW
Australia
Tel: 61-2-9868-6733 Fax: 61-2-9868-6755

Denmark

Microchip Technology Denmark ApS
Regus Business Centre
Lautrup høj 1-3
Ballerup DK-2750 Denmark
Tel: 45 4420 9895 Fax: 45 4420 9910

France

Arizona Microchip Technology SARL
Parc d'Activite du Moulin de Massy
43 Rue du Saule Trapu
Batiment A - 1er Etage
91300 Massy, France
Tel: 33-1-69-53-63-20 Fax: 33-1-69-30-90-79

Germany

Arizona Microchip Technology GmbH
Gustav-Heinemann Ring 125
D-81739 Munich, Germany
Tel: 49-89-627-144 0 Fax: 49-89-627-144-44

Germany

Analog Product Sales
Lochhamer Strasse 13
D-82152 Martinsried, Germany
Tel: 49-89-895650-0 Fax: 49-89-895650-22

Italy

Arizona Microchip Technology SRL
Centro Direzionale Colleoni
Palazzo Taurus 1 V. Le Colleoni 1
20041 Agrate Brianza
Milan, Italy
Tel: 39-039-65791-1 Fax: 39-039-6899883

United Kingdom

Arizona Microchip Technology Ltd.
505 Eskdale Road
Winnersh Triangle
Wokingham
Berkshire, England RG41 5TU
Tel: 44 118 921 5869 Fax: 44-118 921-5820

All rights reserved. © 2001 Microchip Technology Incorporated. Printed in the USA. 1/01  Printed on recycled paper.

01/09/01

Information contained in this publication regarding device applications and the like is intended through suggestion only and may be superseded by updates. It is your responsibility to ensure that your application meets with your specifications. No representation or warranty is given and no liability is assumed by Microchip Technology Incorporated with respect to the accuracy or use of such information, or infringement of patents or other intellectual property rights arising from such use or otherwise. Use of Microchip's products as critical components in life support systems is not authorized except with express written approval by Microchip. No licenses are conveyed, implicitly or otherwise, except as maybe explicitly expressed herein, under any intellectual property rights. The Microchip logo and name are registered trademarks of Microchip Technology Inc. in the U.S.A. and other countries. All rights reserved. All other trademarks mentioned herein are the property of their respective companies.