

50mA, 100mA, and 150mA CMOS LDOs with Shutdown and $\overline{\text{ERROR}}$ Output

FEATURES

- Zero Ground Current for Longer Battery Life
- Very Low Dropout Voltage
- Guaranteed 50mA, 100mA, and 150mA Output (TC1054, TC1055, and TC1186, Respectively)
- High Output Voltage Accuracy
- Standard or Custom Output Voltages
- Power-Saving Shutdown Mode
- $\overline{\text{ERROR}}$ Output Can Be Used as a Low Battery Detector, or Processor Reset Generator
- Over-Current and Over-Temperature Protection
- Space-Saving 5-Pin SOT-23A Package
- Pin Compatible Upgrades for Bipolar Regulators

APPLICATIONS

- Battery Operated Systems
- Portable Computers
- Medical Instruments
- Instrumentation
- Cellular/GSMS/PHS Phones
- Linear Post-Regulators for SMPS
- Pagers

ORDERING INFORMATION

Part Number	Package	Junction Temp. Range
TC1054-xxVCT	5-Pin SOT-23A*	-40°C to +125°C
TC1055-xxVCT	5-Pin SOT-23A*	-40°C to +125°C
TC1186-xxVCT	5-Pin SOT-23A*	-40°C to +125°C

TC1015EV Evaluation Kit for CMOS LDO Family

NOTE: *5-Pin SOT-23A is equivalent to the EIAJ (SC-74A).

Available Output Voltages:

2.5, 2.7, 2.8, 2.85, 3.0, 3.3, 3.6, 4.0, 5.0
xx indicates output voltages

Other output voltages are available. Please contact Microchip Technology for details.

PIN CONFIGURATION

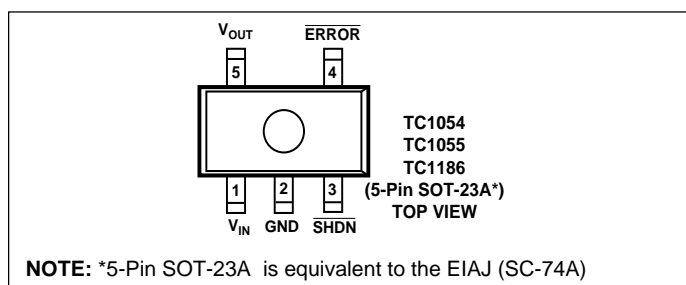

GENERAL DESCRIPTION

The TC1054, TC1055, and TC1186 are high accuracy (typically $\pm 0.5\%$) CMOS upgrades for older (bipolar) low dropout regulators. Designed specifically for battery-operated systems, the devices' CMOS construction eliminates wasted ground current, significantly extending battery life. Total supply current is typically 50 μ A at full load (20 to 60 times lower than in bipolar regulators!).

The devices' key features include ultra low noise operation, very low dropout voltage — typically 85mV (TC1054); 180mV (TC1055); and 270mV (TC1186) at full load — and fast response to step changes in load. An error output ($\overline{\text{ERROR}}$) is asserted when the devices are out-of-regulation (due to a low input voltage or excessive output current). $\overline{\text{ERROR}}$ can be used as a low battery warning or as a processor $\overline{\text{RESET}}$ signal (with the addition of an external RC network). Supply current is reduced to 0.5 μ A (max) and both V_{OUT} and $\overline{\text{ERROR}}$ are disabled when the shutdown input is low. The devices incorporate both over-temperature and over-current protection.

The TC1054, TC1055, and TC1186 are stable with an output capacitor of only 1 μ F and have a maximum output current of 50mA, 100mA, and 150mA, respectively. For higher output current regulators, please see the TC1173 ($I_{\text{OUT}} = 300\text{mA}$) data sheet.

TYPICAL APPLICATION

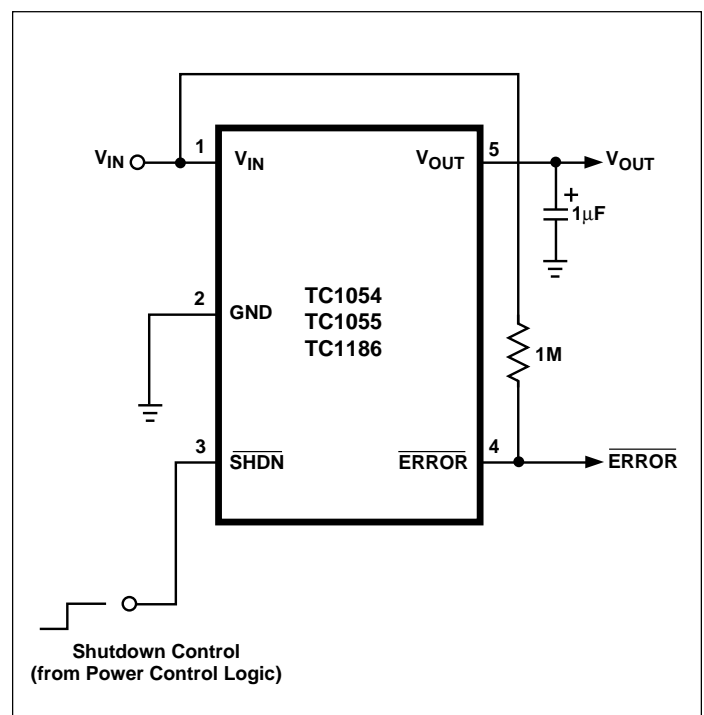

50mA, 100mA, and 150mA CMOS LDOs with Shutdown and Error Output

TC1054
TC1055
TC1186

ABSOLUTE MAXIMUM RATINGS*

Input Voltage	6.5V
Output Voltage	(- 0.3V) to (V _{IN} + 0.3V)
Power Dissipation	Internally Limited
Operating Temperature Range	- 40°C < T _J < 125°C
Storage Temperature	- 65°C to +150°C
Maximum Voltage on Any Pin	V _{IN} +0.3V to - 0.3V
Lead Temperature (Soldering, 10 Sec.)	+260°C

*Stresses above those listed under "Absolute Maximum Ratings" may cause permanent damage to the device. These are stress ratings only and functional operation of the device at these or any other conditions above those indicated in the operation sections of the specifications is not implied. Exposure to Absolute Maximum Rating conditions for extended periods may affect device reliability.

ELECTRICAL CHARACTERISTICS: V_{IN} = V_{OUT} + 1V, I_L = 100μA, C_L = 3.3μF, $\overline{\text{SHDN}} > V_{IH}$, T_A = 25°C, unless otherwise noted.
Boldface type specifications apply for junction temperatures of - 40°C to +125°C.

Symbol	Parameter	Test Conditions	Min	Typ	Max	Units
V _{IN}	Input Operating Voltage		—	—	6.0	V
I _{OUTMAX}	Maximum Output Current	TC1054 TC1055 TC1186	50 100 150	— — —	— — —	mA
V _{OUT}	Output Voltage	Note 1	V_R - 2.5%	V _R ±0.5%	V_R + 2.5%	V
TCV _{OUT}	V _{OUT} Temperature Coefficient	Note 2	— —	20 40	— —	ppm/°C
ΔV _{OUT} /ΔV _{IN}	Line Regulation	(V _R + 1V) ≤ V _{IN} ≤ 6V	—	0.05	0.35	%
ΔV _{OUT} /V _{OUT}	Load Regulation	TC1054;TC1055 TC1186 I _L = 0.1mA to I _{OUTMAX} I _L = 0.1mA to I _{OUTMAX} (Note 3)	— —	0.5 0.5	2 3	%
V _{IN} - V _{OUT}	Dropout Voltage	I _L = 100μA I _L = 20mA I _L = 50mA TC1055; TC1186 I _L = 100mA TC1186 I _L = 150mA (Note 4)	— — — — —	2 65 85 180 270	— — 120 250 400	mV
I _{IN}	Supply Current (Note 8)	$\overline{\text{SHDN}} = V_{IH}$, I _L = 0	—	50	80	μA
I _{INSD}	Shutdown Supply Current	$\overline{\text{SHDN}} = 0V$	—	0.05	0.5	μA
PSRR	Power Supply Rejection Ratio	F _{RE} ≤ 1KHz	—	64	—	dB
I _{OUTSC}	Output Short Circuit Current	V _{OUT} = 0V	—	300	450	mA
ΔV _{OUT} /ΔP _D	Thermal Regulation	Notes 5, 6	—	0.04	—	V/W
T _{SD}	Thermal Shutdown Die Temperature		—	160	—	°C
ΔT _{SD}	Thermal Shutdown Hysteresis		—	10	—	°C
eN	Output Noise	I _L = I _{OUTMAX}	—	260	—	nV/√Hz
SHDN Input						
V _{IH}	$\overline{\text{SHDN}}$ Input High Threshold	V _{IN} = 2.5V to 6.5V	45	—	—	%V _{IN}
V _{IL}	$\overline{\text{SHDN}}$ Input Low Threshold	V _{IN} = 2.5V to 6.5V	—	—	15	%V _{IN}

50mA, 100mA, and 150mA CMOS LDOs with Shutdown and Error Output

TC1054
TC1055
TC1186

ELECTRICAL CHARACTERISTICS: $V_{IN} = V_{OUT} + 1V$, $I_L = 0.1mA$, $C_L = 3.3\mu F$, $\overline{SHDN} > V_{IH}$, $T_A = 25^\circ C$, unless otherwise noted. **BOLDFACE** type specifications apply for junction temperatures of $-40^\circ C$ to $+125^\circ C$.

Symbol	Parameter	Test Conditions	Min	Typ	Max	Units
ERROR Output						
V_{INMIN}	Minimum V_{IN} Operating Voltage		1.0	—	—	V
V_{OL}	Output Logic Low Voltage	1 mA Flows to \overline{ERROR}	—	—	400	mV
V_{TH}	\overline{ERROR} Threshold Voltage	See Figure 2	—	$0.95 \times V_R$	—	V
V_{HYS}	\overline{ERROR} Positive Hysteresis	Note 7	—	50	—	mV

NOTES: 1. V_R is the regulator output voltage setting. For Example: $V_R = 2.5V, 2.7V, 2.85V, 3.0V, 3.3V, 3.6V, 4.0V, 5.0V$.

2. $TC V_{OUT} = \frac{V_{OUTMAX} - V_{OUTMIN} \times 10^6}{V_{OUT} \times \Delta T}$

- Regulation is measured at a constant junction temperature using low duty cycle pulse testing. Load regulation is tested over a load range from 0.1 mA to the maximum specified output current. Changes in output voltage due to heating effects are covered by the thermal regulation specification.
- Dropout voltage is defined as the input to output differential at which the output voltage drops 2% below its nominal value.
- Thermal Regulation is defined as the change in output voltage at a time T after a change in power dissipation is applied, excluding load or line regulation effects. Specifications are for a current pulse equal to I_{LMAX} at $V_{IN} = 6V$ for $T = 10$ msec.
- The maximum allowable power dissipation is a function of ambient temperature, the maximum allowable junction temperature and the thermal resistance from junction-to-air (i.e. T_A, T_J, θ_{JA}). Exceeding the maximum allowable power dissipation causes the device to initiate thermal shutdown. Please see **Thermal Considerations** section of this data sheet for more details.
- Hysteresis voltage is referenced by V_R .
- Apply for Junction Temperatures of $-40^\circ C$ to $+85^\circ C$.

TYPICAL APPLICATION

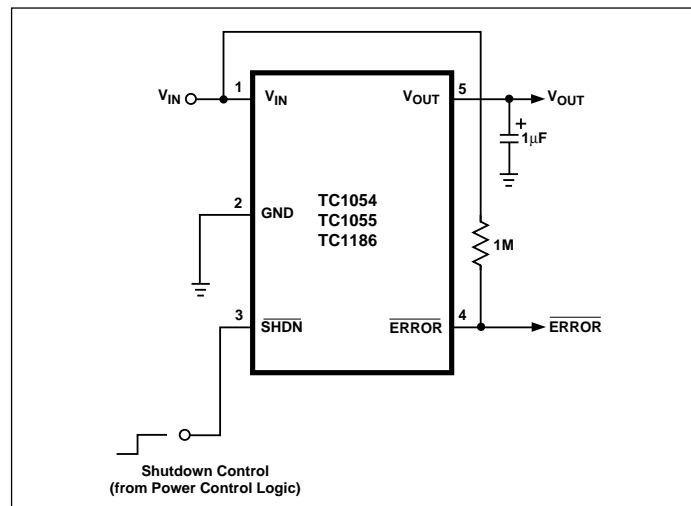

PIN DESCRIPTION

Pin No. (5-Pin SOT-23A)	Symbol	Description
1	V_{IN}	Unregulated supply input.
2	GND	Ground terminal.
3	\overline{SHDN}	Shutdown control input. The regulator is fully enabled when a logic high is applied to this input. The regulator enters shutdown when a logic low is applied to this input. During shutdown, output voltage falls to zero, \overline{ERROR} is open circuited and supply current is reduced to $0.5 \mu A$ (max).
4	\overline{ERROR}	Out-of-Regulation Flag. (Open drain output). This output goes low when V_{OUT} is out-of-tolerance by approximately -5% .
5	V_{OUT}	Regulated voltage output.

TC1054
TC1055
TC1186

DETAILED DESCRIPTION

The TC1054, TC1055, and TC1186 are precision fixed output voltage regulators. (If an adjustable version is desired, please see the TC1070, TC1071 or TC1187 data sheets.) Unlike bipolar regulators, the TC1054, TC1055, and TC1186 supply current does not increase with load current. In addition, V_{OUT} remains stable and within regulation at very low load currents (an important consideration in RTC and CMOS RAM battery back-up applications).

Figure 1 shows a typical application circuit. The regulator is enabled any time the shutdown input ($\overline{\text{SHDN}}$) is at or above V_{IH} , and shutdown (disabled) when $\overline{\text{SHDN}}$ is at or below V_{IL} . $\overline{\text{SHDN}}$ may be controlled by a CMOS logic gate, or I/O port of a microcontroller. If the $\overline{\text{SHDN}}$ input is not required, it should be connected directly to the input supply. While in shutdown, supply current decreases to $0.05\mu\text{A}$ (typical), V_{OUT} falls to zero volts, and $\overline{\text{ERROR}}$ is open-circuited.

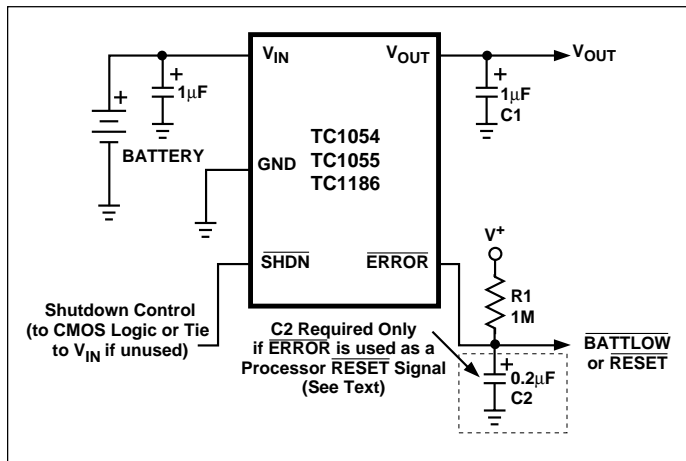

Figure 1. Typical Application Circuit

$\overline{\text{ERROR}}$ Open Drain Output

$\overline{\text{ERROR}}$ is driven low whenever V_{OUT} falls out of regulation by more than -5% (typical). This condition may be caused by low input voltage, output current limiting, or thermal limiting. The $\overline{\text{ERROR}}$ threshold is 5% below rated V_{OUT} regardless of the programmed output voltage value (e.g. $\overline{\text{ERROR}} = V_{\text{OL}}$ at 4.75V (typ.) for a 5.0V regulator and 2.85V (typ.) for a 3.0V regulator). $\overline{\text{ERROR}}$ output operation is shown in Figure 2.

Note that $\overline{\text{ERROR}}$ is active when V_{OUT} falls to V_{TH} , and inactive when V_{OUT} rises above V_{TH} by V_{HYS} .

As shown in Figure 1, $\overline{\text{ERROR}}$ can be used as a battery low flag, or as a processor $\overline{\text{RESET}}$ signal (with the addition of timing capacitor C2). $R1 \times C2$ should be chosen to maintain $\overline{\text{ERROR}}$ below V_{IH} of the processor $\overline{\text{RESET}}$ input for at least 200 msec to allow time for the system to stabilize.

Pull-up resistor R1 can be tied to V_{OUT} , V_{IN} or any other voltage less than $(V_{\text{IN}} + 0.3\text{V})$.

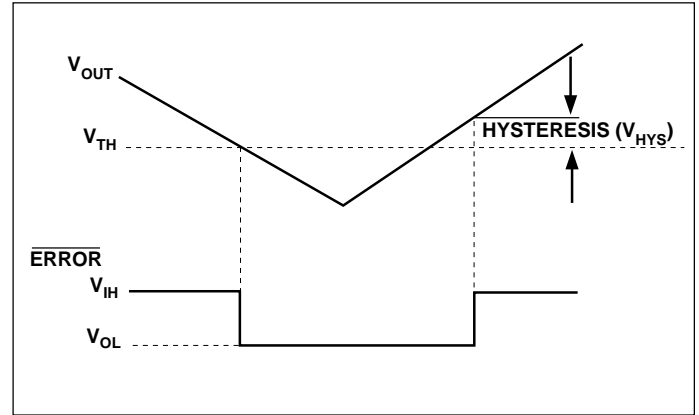

Figure 2. $\overline{\text{ERROR}}$ Output Operation

Output Capacitor

A $1\mu\text{F}$ (min) capacitor from V_{OUT} to ground is recommended. The output capacitor should have an effective series resistance of 5Ω or less, and a resonant frequency above 1MHz. A $1\mu\text{F}$ capacitor should be connected from V_{IN} to GND if there is more than 10 inches of wire between the regulator and the AC filter capacitor, or if a battery is used as the power source. Aluminum electrolytic or tantalum capacitor types can be used. (Since many aluminum electrolytic capacitors freeze at approximately -30°C , solid tantalums are recommended for applications operating below -25°C .) When operating from sources other than batteries, supply-noise rejection and transient response can be improved by increasing the value of the input and output capacitors and employing passive filtering techniques.

Thermal Considerations

Thermal Shutdown

Integrated thermal protection circuitry shuts the regulator off when die temperature exceeds 160°C . The regulator remains off until the die temperature drops to approximately 150°C .

Power Dissipation

The amount of power the regulator dissipates is primarily a function of input and output voltage, and output current. The following equation is used to calculate worst case *actual* power dissipation:

50mA, 100mA, and 150mA CMOS LDOs with Shutdown and Error Output

TC1054
TC1055
TC1186

$$P_D \approx (V_{IN_{MAX}} - V_{OUT_{MIN}})I_{LOAD_{MAX}}$$

Where:

P_D = Worst case actual power dissipation

$V_{IN_{MAX}}$ = Maximum voltage on V_{IN}

$V_{OUT_{MIN}}$ = Minimum regulator output voltage

$I_{LOAD_{MAX}}$ = Maximum output (load) current

Equation 1.

The maximum *allowable* power dissipation (Equation 2) is a function of the maximum ambient temperature (T_{AMAX}), the maximum allowable die temperature (125°C) and the thermal resistance from junction-to-air (θ_{JA}). 5-Pin SOT-23A package has a θ_{JA} of approximately 220°C/Watt when mounted on a single layer FR4 dielectric copper clad PC board.

$$P_{D_{MAX}} = \frac{(T_{J_{MAX}} - T_{AMAX})}{\theta_{JA}}$$

Where all terms are previously defined.

Equation 2.

Equation 1 can be used in conjunction with Equation 2 to ensure regulator thermal operation is within limits. For example:

Given:

$$V_{IN_{MAX}} = 3.0V \pm 5\%$$

$$V_{OUT_{MIN}} = 2.7V - 2.5\%$$

$$I_{LOAD} = 40mA$$

$$T_{AMAX} = 55^\circ C$$

- Find:
1. Actual power dissipation
 2. Maximum allowable dissipation

Actual power dissipation:

$$\begin{aligned} P_D &\approx (V_{IN_{MAX}} - V_{OUT_{MIN}})I_{LOAD_{MAX}} \\ &= [(3.0 \times 1.05) - (2.7 \times .975)]40 \times 10^{-3} \\ &= 20.7mW \end{aligned}$$

Maximum allowable power dissipation:

$$\begin{aligned} P_{D_{MAX}} &= \frac{(T_{J_{MAX}} - T_{AMAX})}{\theta_{JA}} \\ &= \frac{(125 - 55)}{220} \\ &= 318mW \end{aligned}$$

In this example, the TC1054 dissipates a maximum of only 20.7mW; far below the allowable limit of 318mW. In a similar manner, Equation 1 and Equation 2 can be used to calculate maximum current and/or input voltage limits.

Layout Considerations

The primary path of heat conduction out of the package is via the package leads. Therefore, layouts having a ground plane, wide traces at the pads, and wide power supply bus lines combine to lower θ_{JA} and therefore increase the maximum allowable power dissipation limit.

50mA, 100mA, and 150mA CMOS LDOs with Shutdown and Error Output

TC1054
TC1055
TC1186

TYPICAL CHARACTERISTICS: (Unless otherwise specified, all parts are measured at Temperature = 25°C)

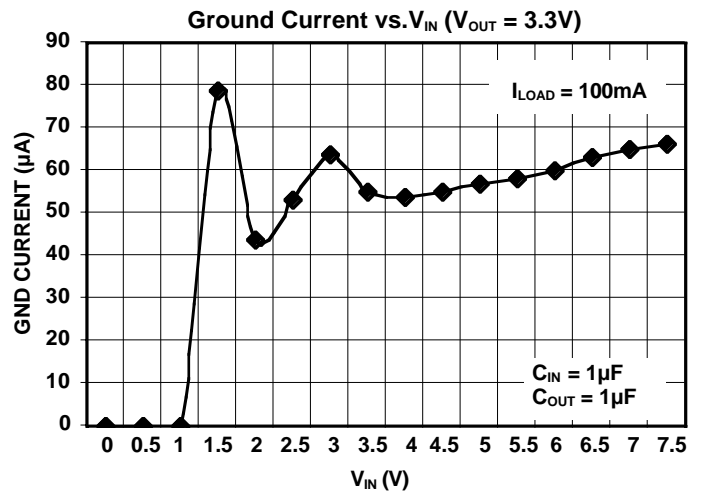
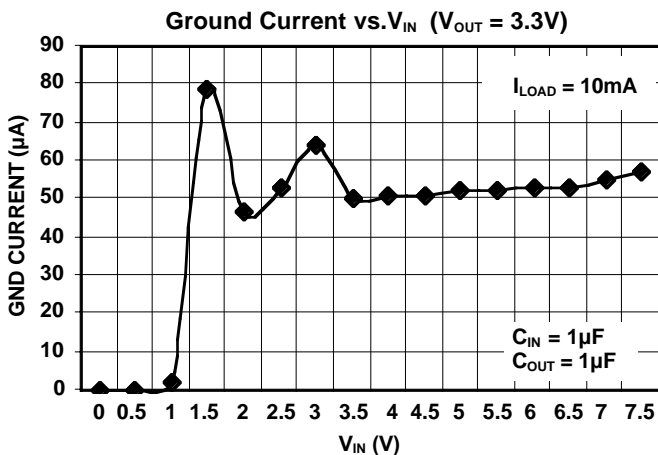
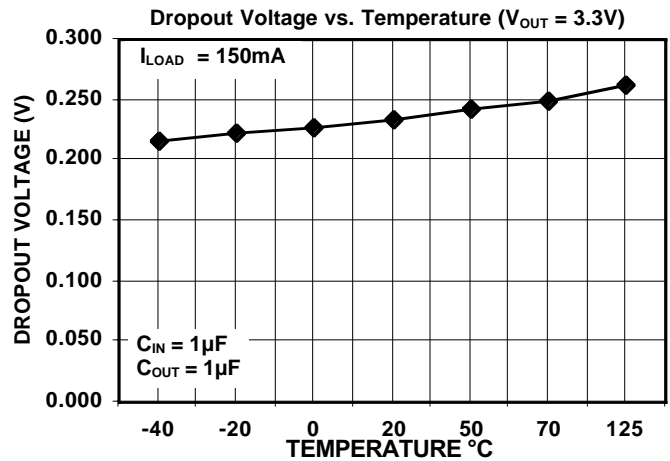
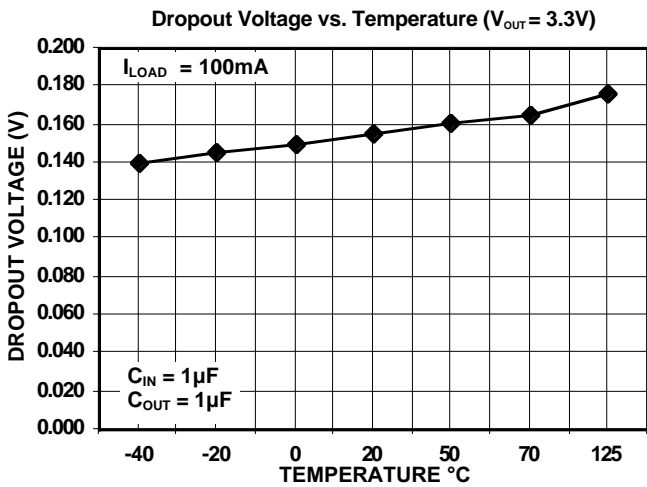
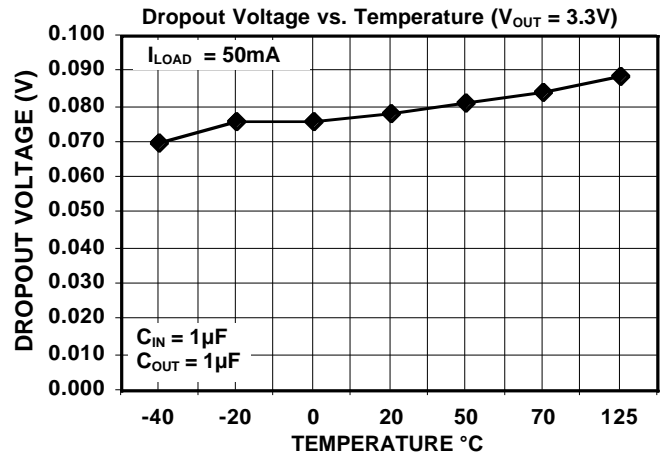
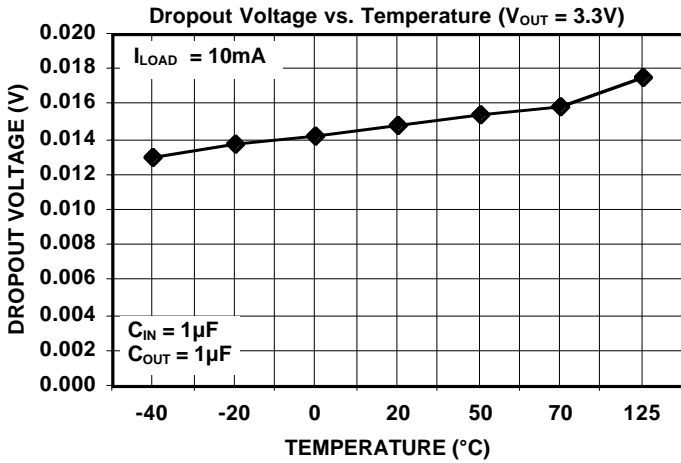

50mA, 100mA, and 150mA CMOS LDOs with Shutdown and Error Output

TC1054
TC1055
TC1186

TYPICAL CHARACTERISTICS: (Unless otherwise specified, all parts are measured at Temperature = 25°C

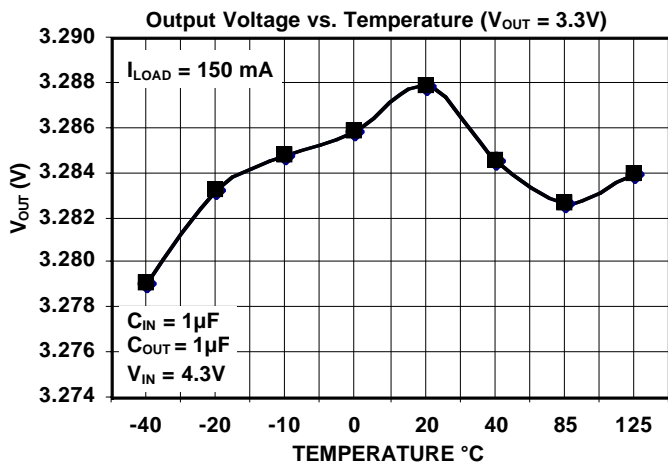
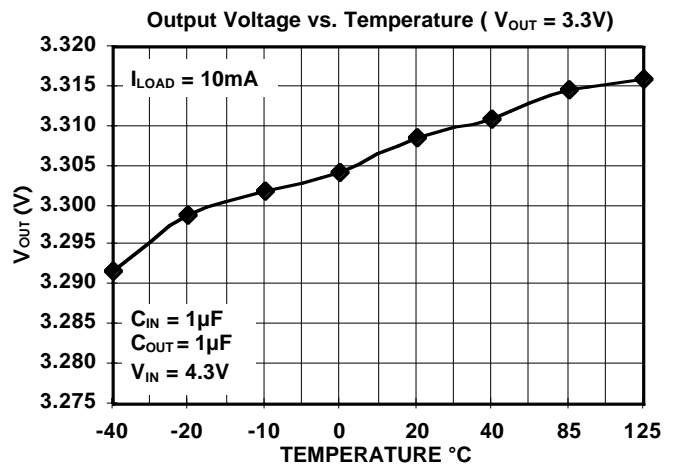
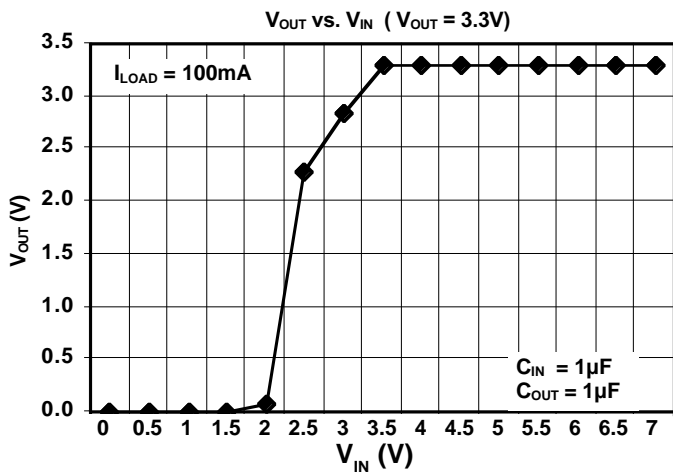
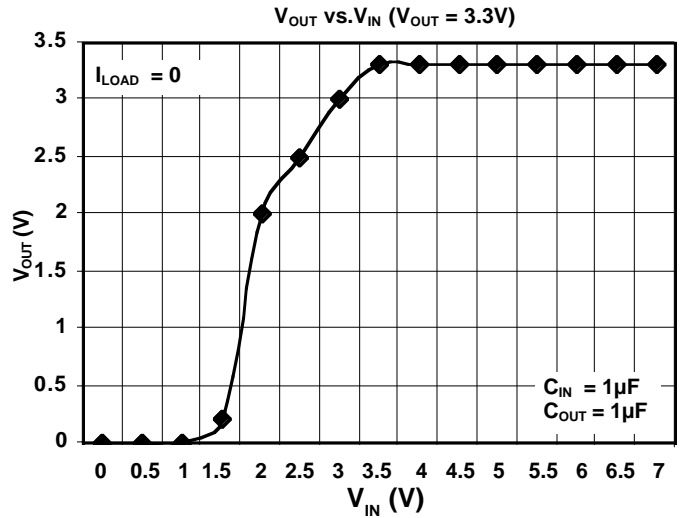
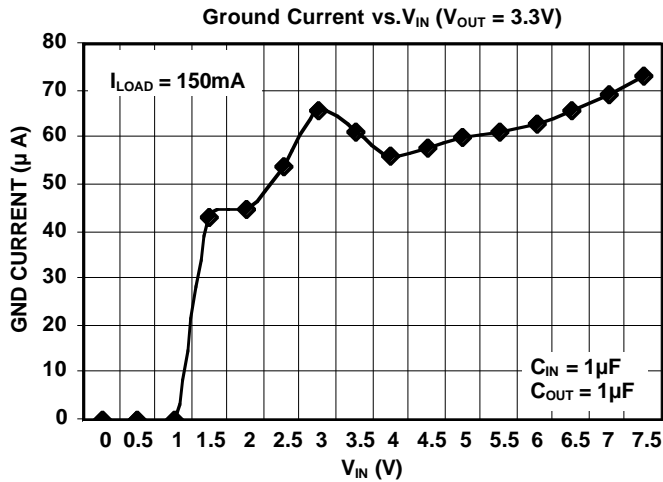

50mA, 100mA, and 150mA CMOS LDOs with Shutdown and Error Output

TC1054
TC1055
TC1186

TYPICAL CHARACTERISTICS

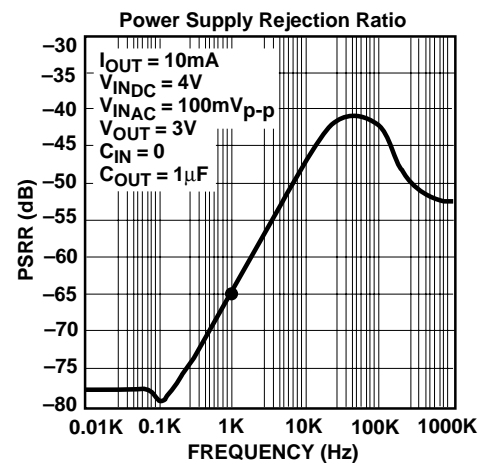
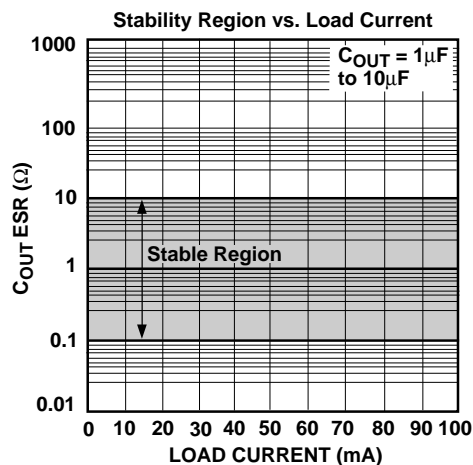
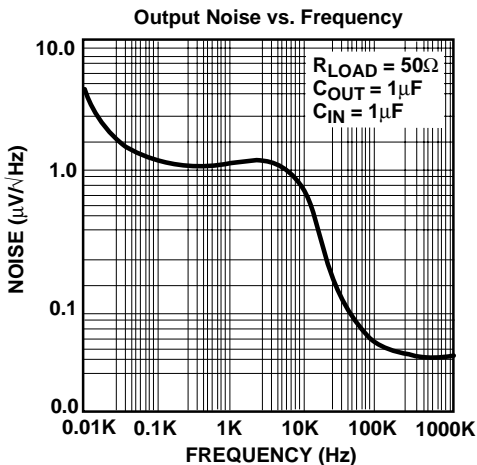
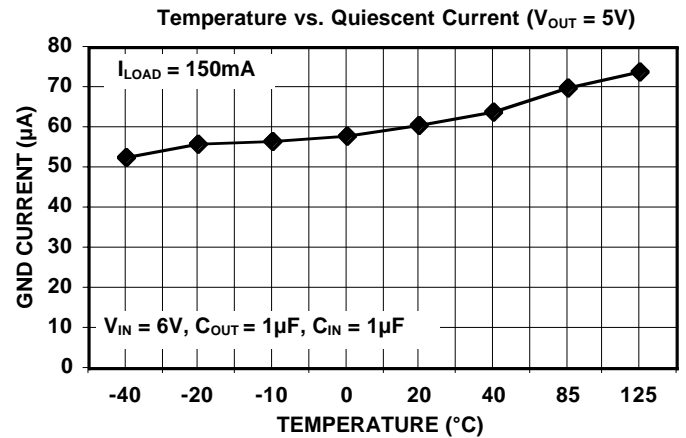
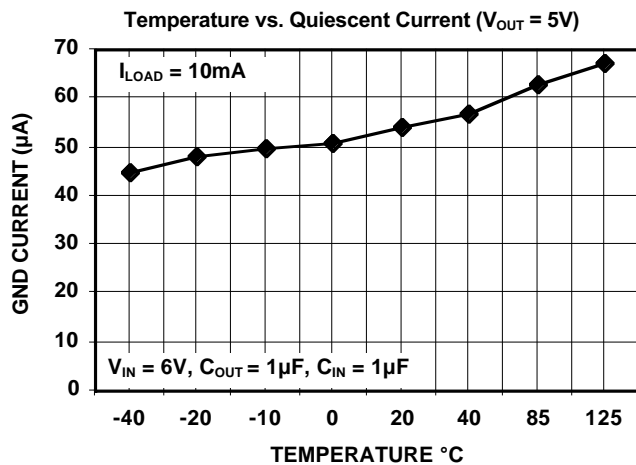
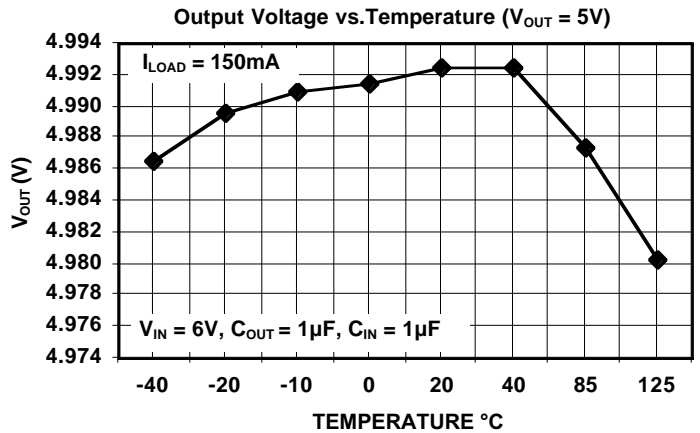
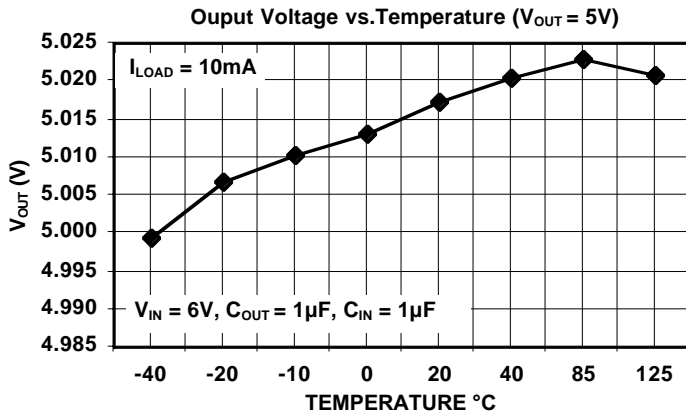

50mA, 100mA, and 150mA CMOS LDOs with Shutdown and Error Output

TC1054
TC1055
TC1186

TYPICAL CHARACTERISTICS

Measure Rise Time of 3.3V LDO

Conditions: $C_{IN} = 1\mu F$, $C_{OUT} = 1\mu F$, $I_{LOAD} = 100mA$, $V_{IN} = 4.3V$,
Temp = 25°C, Rise Time = 184 μS

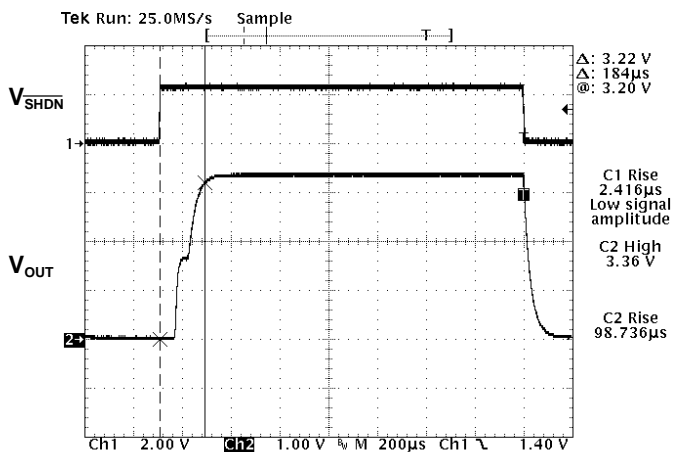

Measure Rise Time of 5.0V LDO

Conditions: $C_{IN} = 1\mu F$, $C_{OUT} = 1\mu F$, $I_{LOAD} = 100mA$, $V_{IN} = 6V$,
Temp = 25°C, Rise Time = 192 μS

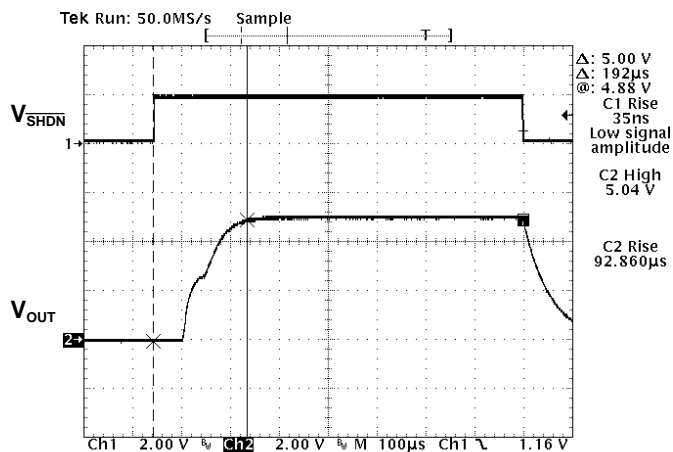

Measure Fall Time of 3.3V LDO

Conditions: $C_{IN} = 1\mu F$, $C_{OUT} = 1\mu F$, $I_{LOAD} = 100mA$, $V_{IN} = 4.3V$,
Temp = 25°C, Fall Time = 52 μS

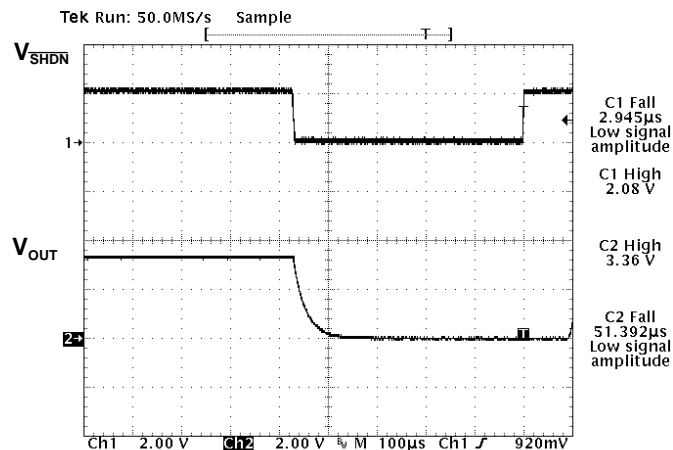

Measure Fall Time of 5.0V LDO

Conditions: $C_{IN} = 1\mu F$, $C_{OUT} = 1\mu F$, $I_{LOAD} = 100mA$, $V_{IN} = 6V$,
Temp = 25°C, Fall Time = 88 μS

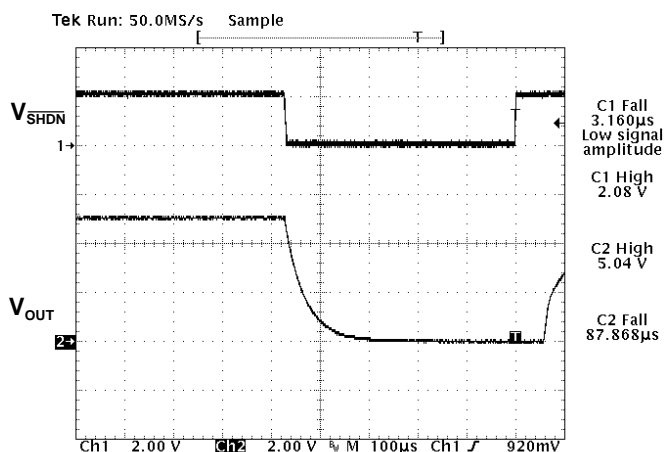

50mA, 100mA, and 150mA CMOS LDOs with Shutdown and Error Output

TC1054
TC1055
TC1186

TYPICAL CHARACTERISTICS

Thermal Shutdown Response of 5.0V LDO

Conditions: $V_{IN} = 6V, C_{IN} = 0\mu F, C_{OUT} = 1\mu F$

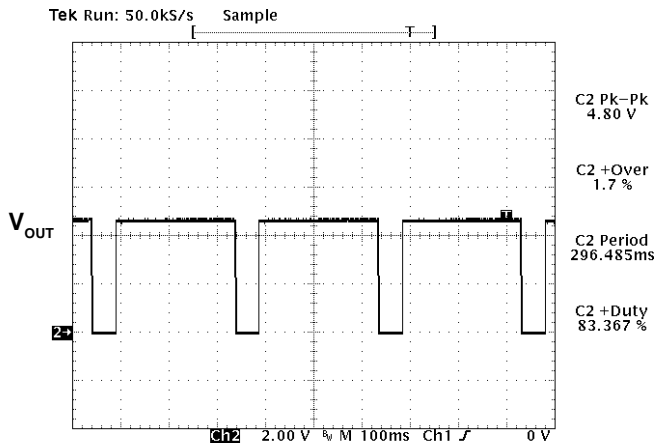

I_{LOAD} was increased until temperature of die reached about 160°C, at which time integrated thermal protection circuitry shuts the regulator off when die temperature exceeds approximately 160°C. The regulator remains off until die temperature drops to approximately 150°C.

MARKINGS

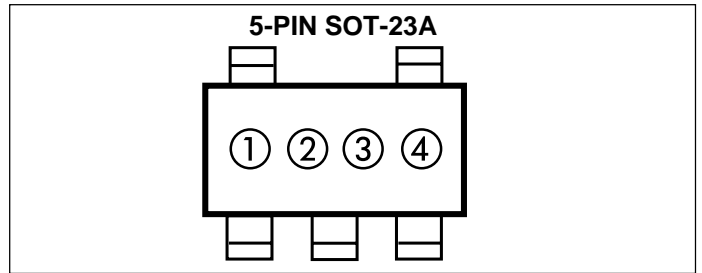

① & ② = part number code + temperature range and voltage

(V)	TC1054 Code	TC1055 Code	TC1186 Code
2.5	C1	D1	P1
2.7	C2	D2	P2
2.8	CZ	DZ	PZ
2.85	C8	D8	P8
3.0	C3	D3	P3
3.3	C5	D5	P5
3.6	C9	D9	P9
4.0	C0	D0	P0
5.0	C7	D7	P7

③ represents year and quarter code

④ represents lot ID number

TAPING FORM

Component Taping Orientation for 5-Pin SOT-23A (EIAJ SC-74A) Devices

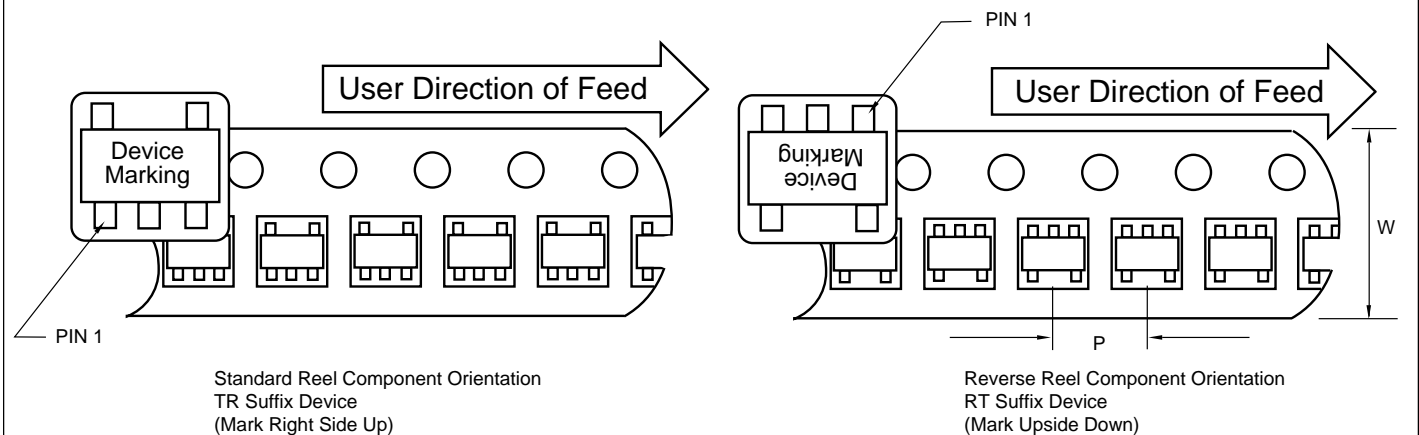

Carrier Tape, Number of Components Per Reel and Reel Size

Package	Carrier Width (W)	Pitch (P)	Part Per Full Reel	Reel Size
5-Pin SOT-23A	8 mm	4 mm	3000	7 in

50mA, 100mA, and 150mA CMOS LDOs with Shutdown and Error Output

TC1054
TC1055
TC1186

PACKAGE DIMENSIONS

5-Pin SOT-23A (EIAJ SC-74A)

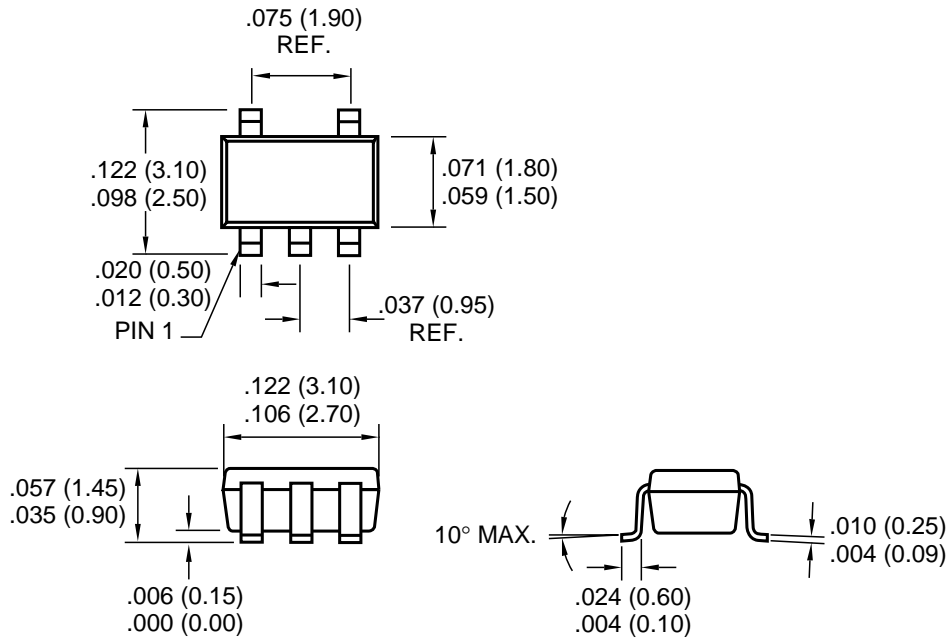

Dimensions: inches (mm)



WORLDWIDE SALES AND SERVICE

AMERICAS

Corporate Office

2355 West Chandler Blvd.
Chandler, AZ 85224-6199
Tel: 480-792-7200 Fax: 480-792-7277
Technical Support: 480-792-7627
Web Address: <http://www.microchip.com>

Rocky Mountain

2355 West Chandler Blvd.
Chandler, AZ 85224-6199
Tel: 480-792-7966 Fax: 480-792-7456

Atlanta

500 Sugar Mill Road, Suite 200B
Atlanta, GA 30350
Tel: 770-640-0034 Fax: 770-640-0307

Austin

Analog Product Sales
8303 MoPac Expressway North
Suite A-201
Austin, TX 78759
Tel: 512-345-2030 Fax: 512-345-6085

Boston

2 Lan Drive, Suite 120
Westford, MA 01886
Tel: 978-692-3848 Fax: 978-692-3821

Boston

Analog Product Sales
Unit A-8-1 Millbrook Tarry Condominium
97 Lowell Road
Concord, MA 01742
Tel: 978-371-6400 Fax: 978-371-0050

Chicago

333 Pierce Road, Suite 180
Itasca, IL 60143
Tel: 630-285-0071 Fax: 630-285-0075

Dallas

4570 Westgrove Drive, Suite 160
Addison, TX 75001
Tel: 972-818-7423 Fax: 972-818-2924

Dayton

Two Prestige Place, Suite 130
Miamisburg, OH 45342
Tel: 937-291-1654 Fax: 937-291-9175

Detroit

Tri-Atria Office Building
32255 Northwestern Highway, Suite 190
Farmington Hills, MI 48334
Tel: 248-538-2250 Fax: 248-538-2260

Los Angeles

18201 Von Karman, Suite 1090
Irvine, CA 92612
Tel: 949-263-1888 Fax: 949-263-1338

Mountain View

Analog Product Sales
1300 Terra Bella Avenue
Mountain View, CA 94043-1836
Tel: 650-968-9241 Fax: 650-967-1590

New York

150 Motor Parkway, Suite 202
Hauppauge, NY 11788
Tel: 631-273-5305 Fax: 631-273-5335

San Jose

Microchip Technology Inc.
2107 North First Street, Suite 590
San Jose, CA 95131
Tel: 408-436-7950 Fax: 408-436-7955

Toronto

6285 Northam Drive, Suite 108
Mississauga, Ontario L4V 1X5, Canada
Tel: 905-673-0699 Fax: 905-673-6509

ASIA/PACIFIC

China - Beijing

Microchip Technology Beijing Office
Unit 915
New China Hong Kong Manhattan Bldg.
No. 6 Chaoyangmen Beidajie
Beijing, 100027, No. China
Tel: 86-10-85282100 Fax: 86-10-85282104

China - Shanghai

Microchip Technology Shanghai Office
Room 701, Bldg. B
Far East International Plaza
No. 317 Xian Xia Road
Shanghai, 200051
Tel: 86-21-6275-5700 Fax: 86-21-6275-5060

Hong Kong

Microchip Asia Pacific
RM 2101, Tower 2, Metroplaza
223 Hing Fong Road
Kwai Fong, N.T., Hong Kong
Tel: 852-2401-1200 Fax: 852-2401-3431

India

Microchip Technology Inc.
India Liaison Office
Divyasree Chambers
1 Floor, Wing A (A3/A4)
No. 11, O'Shaughnessy Road
Bangalore, 560 025, India
Tel: 91-80-2290061 Fax: 91-80-2290062

Japan

Microchip Technology Intl. Inc.
Benex S-1 6F
3-18-20, Shinyokohama
Kohoku-Ku, Yokohama-shi
Kanagawa, 222-0033, Japan
Tel: 81-45-471- 6166 Fax: 81-45-471-6122

Korea

Microchip Technology Korea
168-1, Youngbo Bldg. 3 Floor
Samsung-Dong, Kangnam-Ku
Seoul, Korea
Tel: 82-2-554-7200 Fax: 82-2-558-5934

ASIA/PACIFIC (continued)

Singapore

Microchip Technology Singapore Pte Ltd.
200 Middle Road
#07-02 Prime Centre
Singapore, 188980
Tel: 65-334-8870 Fax: 65-334-8850

Taiwan

Microchip Technology Taiwan
11F-3, No. 207
Tung Hua North Road
Taipei, 105, Taiwan
Tel: 886-2-2717-7175 Fax: 886-2-2545-0139

EUROPE

Australia

Microchip Technology Australia Pty Ltd
Suite 22, 41 Rawson Street
Epping 2121, NSW
Australia
Tel: 61-2-9868-6733 Fax: 61-2-9868-6755

Denmark

Microchip Technology Denmark ApS
Regus Business Centre
Lautrup hoj 1-3
Ballerup DK-2750 Denmark
Tel: 45 4420 9895 Fax: 45 4420 9910

France

Arizona Microchip Technology SARL
Parc d'Activite du Moulin de Massy
43 Rue du Saule Trapu
Batiment A - 1er Etage
91300 Massy, France
Tel: 33-1-69-53-63-20 Fax: 33-1-69-30-90-79

Germany

Arizona Microchip Technology GmbH
Gustav-Heinemann Ring 125
D-81739 Munich, Germany
Tel: 49-89-627-144 0 Fax: 49-89-627-144-44

Germany

Analog Product Sales
Lochhamer Strasse 13
D-82152 Martinsried, Germany
Tel: 49-89-895650-0 Fax: 49-89-895650-22

Italy

Arizona Microchip Technology SRL
Centro Direzionale Colleoni
Palazzo Taurus 1 V. Le Colleoni 1
20041 Agrate Brianza
Milan, Italy
Tel: 39-039-65791-1 Fax: 39-039-6899883

United Kingdom

Arizona Microchip Technology Ltd.
505 Eskdale Road
Winnersh Triangle
Wokingham
Berkshire, England RG41 5TU
Tel: 44 118 921 5869 Fax: 44-118 921-5820

All rights reserved. © 2001 Microchip Technology Incorporated. Printed in the USA. 1/01  Printed on recycled paper.

01/09/01

Information contained in this publication regarding device applications and the like is intended through suggestion only and may be superseded by updates. It is your responsibility to ensure that your application meets with your specifications. No representation or warranty is given and no liability is assumed by Microchip Technology Incorporated with respect to the accuracy or use of such information, or infringement of patents or other intellectual property rights arising from such use or otherwise. Use of Microchip's products as critical components in life support systems is not authorized except with express written approval by Microchip. No licenses are conveyed, implicitly or otherwise, except as maybe explicitly expressed herein, under any intellectual property rights. The Microchip logo and name are registered trademarks of Microchip Technology Inc. in the U.S.A. and other countries. All rights reserved. All other trademarks mentioned herein are the property of their respective companies.