

SURROUND PROCESSOR FOR A CTV

TA8776N is a surround processor controlled I²C bus. It incorporates following functions on a 30pin dual-in-line shrink-type plastic package.

FEATURES

Surround circuit

- Simulated Surround
- Hall Ambience
- Dolby Surround (Input Terminal)
- 3D Center Output (L + R) for a super woofer
- Surround Output (L - R)

Sound processor circuit

- Input Switch
- Volume Adj.
- Balance Adj.
- Surround Level Adj.
- Bass Adj.
- Treble Adj.

I²C interface

- Filter Adj. by Bus line
- DAC Output (2ch)

BLOCK DIAGRAM

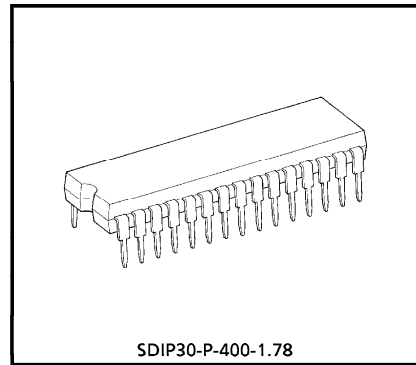

Weight : 1.99g (Typ.)

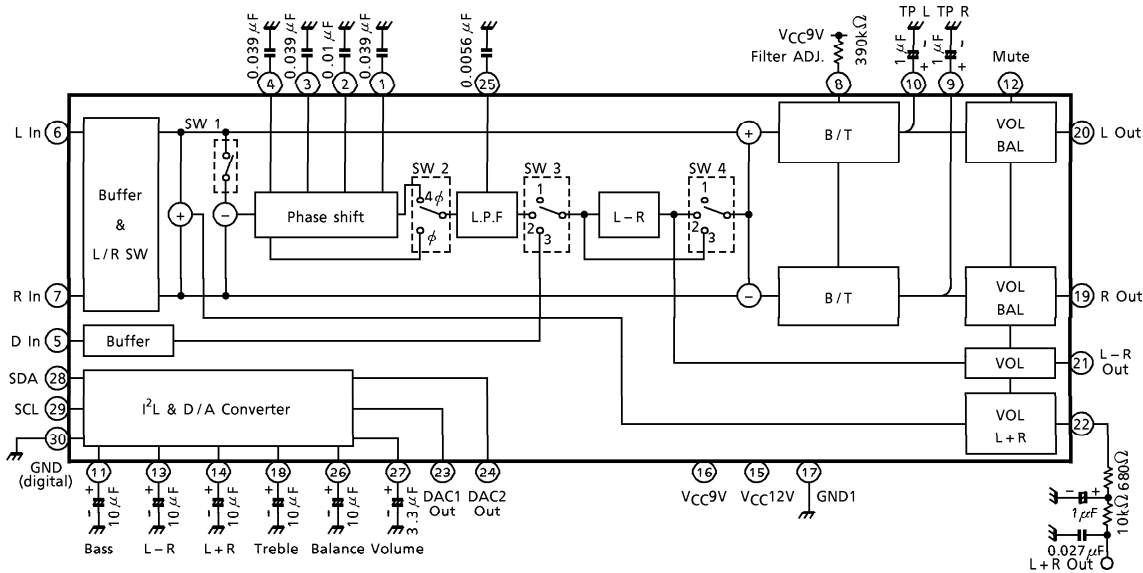

● The information contained herein is presented only as a guide for the applications of our products. No responsibility is assumed by TOSHIBA CORPORATION for any infringements of intellectual property or other rights of the third parties which may result from its use. No license is granted by implication or otherwise under any intellectual property or other rights of TOSHIBA CORPORATION or others.

● TOSHIBA is continually working to improve the quality and the reliability of its products. Nevertheless, semiconductor devices in general can malfunction or fail due to their inherent electrical sensitivity and vulnerability to physical stress. It is the responsibility of the buyer, when utilizing TOSHIBA products, to observe standards of safety, and to avoid situations in which a malfunction or failure of a TOSHIBA product could cause loss of human life, bodily injury or damage to property.

In developing your designs, please ensure that TOSHIBA products are used within specified operating ranges as set forth in the most recent products specifications. Also, please keep in mind the precautions and conditions set forth in the TOSHIBA Semiconductor Reliability Handbook.

TERMINAL FUNCTION

PIN No.	NAME	FUNCTION	INTERFACE CIRCUIT
1 2 3 4	$\phi 4$ $\phi 3$ $\phi 2$ $\phi 1$	Terminals for capacitors of the phase shifter blocks. Value of phase shift in each block is ϕ [deg.] = $-2 \tan^{-1}(2\pi fCR)$ C is capacitance of external capacitor. R is resistance of internal register (10k Ω (Typ.)).	
5 6 7	Dolby In L In R In	Input terminals. "L In" is for L-ch signal. "R In" is for R-ch signal. "Dolby In" is for decoded Dolby Signal.	
8	Filter Adj.	Terminal for tone control block. Cross-over frequency is set by sink current of this terminal. If 390k Ω connect, cross-over frequency is about 1kHz.	
9 10	TP (R) TP (L)	Terminals for capacitors for offset cancel circuits.	
11 18	Bass Filter Treble Filter	Terminals for tone control block. Control current is smoothed by external capacitors.	

PIN No.	NAME	FUNCTION	INTERFACE CIRCUIT
12	Mute	Input terminal for muting. Applied voltage more than 2V to this terminal, Muting is active.	
13 14	L-R Filter L+R Filter	Terminals for level control blocks. Control current is smoothed by external capacitors.	
15	VCC 9V	VCC (9V)	—
16	VCC 12V	VCC (12V)	—
17	GND (Analogue)	Gnd for Analogue	—
19 20 21 22	R Out. L Out. L-R Out. L+R Out.	Output terminals.	
23 24	DAC 1 DAC 2	Open collector switches controlled by I ² C bus.	
25	Surround L.P.F.	Terminal for surround L.P.F. block. Cut-off frequency of the surround L.P.F. is set by external capacitor. $f_c = \frac{1}{2\pi RC} \text{ Hz}$ R is resistance of internal register (10kΩ (Typ.)). C is capacitance of external capacitor.	

PIN No.	NAME	FUNCTION	INTERFACE CIRCUIT
26	Balance Filter	Terminal for balance control block. Control current is smoothed by external capacitor.	
27	Volume Filter	Terminal for volume control block. Control current is smoothed by external capacitor.	
28	SDA	Terminal for SDA.	
29	SCL	Terminal for SCL.	
30	GND (Digital)	Gnd for Digital.	—

I²C BUS CONTROL

- Main Address 80 (h) : (h) = Hexa Decimal
- Sub Address

Function-sub address reference table

FUNCTION	SUB ADDRESS	POWER ON DEFAULT	EFFECTIVE DATA RANGE
BASS	01 (h)	32 (h) (Center)	0~64 (h)
Treble	02 (h)	32 (h) (Center)	
Volume	03 (h)	0 (h) (Minimum)	
L - R	04 (h)	0 (h) (Minimum)	
L + R	05 (h)	0 (h) (Minimum)	
Balance	06 (h)	32 (h) (Center)	
Surround / DAC Input Mode	07 (h)	F0 (h) (Normal / DAC1, 2 L / Surr. Off)	—
Mute	08 (h)	3 (h) (L-R Mute, L + R Mute)	—
Filter Adjustment	09 (h)	0 (h) (Minimum)	0~0F (h)

Mode explanation (Input mode : normal)

MODE	OUTPUT			
	Lout	Rout	(L - R) out	(L + R) out
OFF	L	R	—	L + R
MONO B1	$M - k (M) 4\phi$	$M + k (M) 4\phi$	$-k (M) 4\phi$	M
STEREO A1	$L + k (L - R) \phi$	$R - k (L - R) \phi$	$k (L - R) \phi$	L + R
STEREO B1	$L + k (L - R) 4\phi$	$R - k (L - R) 4\phi$	$k (L - R) 4\phi$	L + R
DOLBY	L	R	$k \cdot D$	L + R
MONO B2	$M - (M) 4\phi$	$M + (M) 4\phi$	$-k (M) 4\phi$	M
STEREO A2	$L + (L - R) \phi$	$R - (L - R) \phi$	$k (L - R) \phi$	L + R
STEREO B2	$L + (L - R) 4\phi$	$R - (L - R) 4\phi$	$k (L - R) 4\phi$	L + R
MONO B3	M	M	$-k (M) 4\phi$	M
STEREO A3	L	R	$k (L - R) \phi$	L + R
STEREO B3	L	R	$k (L - R) 4\phi$	L + R

- M : Monoural Input Signal
D : Dolby Surround Input Signal
k : Co-efficient
() ϕ : Phase Shifted ϕ
() 4ϕ : Phase Shifted 4ϕ

Data input mode reference table
[Sub Address : 07 (h)]

DATA		MODE	OUTPUT	
MSB	LSB		Lout	Rout
x	x 1 1 x x x x	Normal	L	R
x	x 1 0 x x x x	L	L	L
x	x 0 1 x x x x	R	R	R
x	x 0 0 x x x x	Reverse	R	L

x : Don't care

Data surround mode reference table
[Sub Address : 07 (h)]

DATA		MODE	INTERNAL SWITCH			
MSB	LSB		SW 1	SW 2	SW 3	SW 4
x	x x x x 0 0 0 0	OFF	ON	ϕ	1	1
x	x x x x 0 0 0 1	MONO B1	OFF	4 ϕ	2	2
x	x x x x 0 0 1 0	STEREO A1	ON	ϕ	2	2
x	x x x x 0 0 1 1	STEREO B1	ON	4 ϕ	2	2
x	x x x x 0 1 0 0	DOLBY	ON	ϕ	3	1
x	x x x x 0 1 0 1	MONO B2	OFF	4 ϕ	2	3
x	x x x x 0 1 1 0	STEREO A2	ON	ϕ	2	3
x	x x x x 0 1 1 1	STEREO B2	ON	4 ϕ	2	3
x	x x x x 1 0 0 0	(OFF)	ON	ϕ	1	1
x	x x x x 1 0 0 1	MONO B3	OFF	4 ϕ	2	1
x	x x x x 1 0 1 0	STEREO A3	ON	ϕ	2	1
x	x x x x 1 0 1 1	STEREO B3	ON	4 ϕ	2	1
x	x x x x 1 1 0 0	(OFF)	ON	ϕ	1	1
x	x x x x 1 1 0 1	(OFF)	ON	ϕ	1	1
x	x x x x 1 1 1 0	(OFF)	ON	ϕ	1	1
x	x x x x 1 1 1 1	(OFF)	ON	ϕ	1	1

x : Don't care

Data DAC output reference table
[Sub Address : 07 (h)]

DATA		OUTPUT*	
MSB	LSB	DAC 1	DAC 2
0	0 x x x x x x	H	H
0	1 x x x x x x	H	L
1	0 x x x x x x	L	H
1	1 x x x x x x	L	L

x : Don't care
* : Open Collector Output

Data mute mode reference table
[Sub Address : 08 (h)]

DATA		Mute 1	Mute 2
MSB	LSB	(L, R)	(L-R, L+R)
x	x x x x x x 0 0	OFF	OFF
x	x x x x x x 0 1	ON	ON
x	x x x x x x 1 0	OFF	ON
x	x x x x x x 1 1	ON	ON

x : Don't care

I²C BUS CONTROLLED FORMAT SUMMARY

Bus controlled format of TA8776N is based on I²C Bus Control format of Philips.

Data transfer format

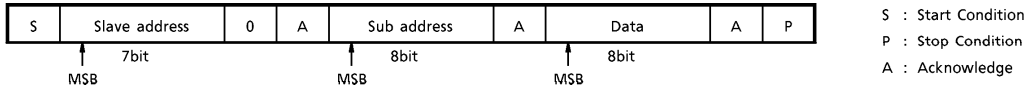

(1) Start and stop condition

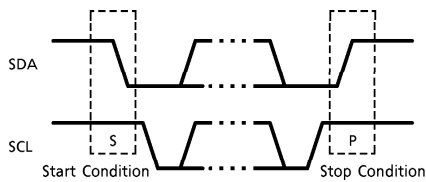

(2) Bit transfer

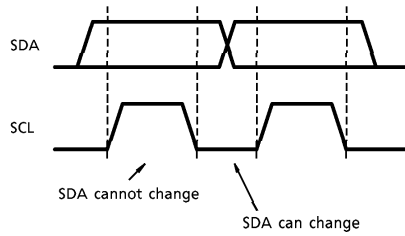

(3) Acknowledge

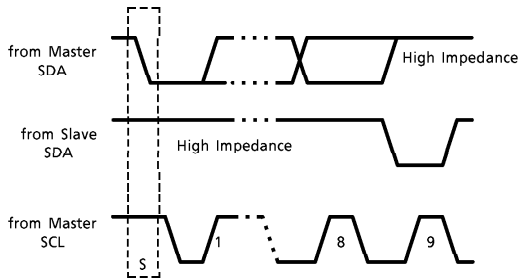

(4) Slave address

A6	A5	A4	A3	A2	A1	A0	R/W
1	0	0	0	0	0	0	0

Purchase of TOSHIBA I²C components conveys a license under the Philips I²C Patent Rights to use these components in an I²C system, provided that the system conforms to the I²C Standard Specification as defined by Philips.

MAXIMUM RATINGS (Ta = 25°C)

CHARACTERISTIC	SYMBOL	RATING	UNIT
Supply Voltage	V _{CC}	15	V
Power Dissipation	P _{Dmax}	1400 (Note 1)	mW
Operating Temperature	T _{opr}	-20~65	°C
Storage Temperature	T _{stg}	-55~150	°C

(Note 1) When using the device at above Ta = 25°C, decrease the power dissipation by 12.5mW for each increase of 1°C.

(Note 2) As this IC is weak in a surge voltage, handle it with care from being damage.

RECOMMENDED SUPPLY VOLTAGE

PIN No.	PIN NAME	MIN.	TYP.	MAX.	UNIT
15	V _{CC} 12V	10.8	12.0	13.2	V
16	V _{CC} 9V	8.1	9.0	9.9	V

ELECTRICAL CHARACTERISTICS

DC voltage characteristics (V_{CCPin15} = 12V, V_{CCPin16} = 9V, Ta = 25°C)

PIN No.	PIN NAME	SYMBOL	MIN.	TYP.	MAX.	UNIT
1	φ4	V1	3.9	4.4	4.9	V
2	φ3	V2	3.9	4.4	4.9	V
3	φ2	V3	3.9	4.4	4.9	V
4	φ1	V4	3.9	4.4	4.9	V
5	DOLBY In	V5	3.9	4.4	4.9	V
6	L In	V6	3.9	4.4	4.9	V
7	R In	V7	3.9	4.4	4.9	V
8	Filter Adj.	V8	1.4	1.9	2.4	V
9	TP R	V9	3.7	4.2	4.2	V
10	TP L	V10	3.7	4.2	4.2	V
11	BASS Filter	V11	3.9	4.4	4.9	V
12	Mute	V12	—	0.0	0.5	V
13	L - R Filter	V13	3.6	4.1	4.6	V
14	L + R Filter	V14	3.6	4.1	4.6	V
18	Treble Filter	V18	3.9	4.4	4.9	V
19	R Out	V19	4.5	5.0	5.5	V
20	L Out	V20	4.5	5.0	5.5	V
21	L - R Out	V21	4.5	5.0	5.5	V
22	L + R Out	V22	4.5	5.0	5.5	V
23	DAC1 out (ON)	V23	—	0.1	0.4	V
24	DAC2 out (ON)	V24	—	0.1	0.4	V
25	Surround L.P.F.	V25	3.7	4.2	4.7	V
26	Balance Filter	V26	5.5	6.0	6.5	V
27	Volume Filter	V27	3.0	3.5	4.0	V

TA8776N - 8

1996-09-02

TOSHIBA CORPORATION

DC CURRENT CHARACTERISTICS ($V_{CCpin15} = 12V$, $V_{CCpin16} = 9V$, $T_a = 25^\circ C$)

PIN No.	PIN NAME	SYMBOL	MIN.	TYP.	MAX.	UNIT
15	$V_{CC} 12V$	I15	8.0	17.0	25.0	mA
16	$V_{CC} 9V$	I16	22.0	45.0	68.0	mA

AC CHARACTERISTICS (Unless otherwise specified $V_{CCpin15} = 12V$, $V_{CCpin16} = 9V$, $T_a = 25^\circ C$)

CHARACTERISTIC	SYMBOL	TEST CIRCUIT	TEST CONDITION	MIN.	TYP.	MAX.	UNIT
Gain	L-ch	—	(Note 1)	- 2.0	0.0	2.0	dB
	R-ch						
	L - R						
	Dolby						
	L + R						
Total Harmonic Distortion THD	L-ch	—	(Note 2)	—	0.25	1.1	%
	R-ch						
	L - R						
	Dolby						
	L + R						
S / N	L-ch	—	(Note 3)	55	60	—	dB
	R-ch						
	L - R						
	Dolby						
	L + R						
Surround Sound Phase		—	(Note 4)	- 345	- 300	- 245	°
Frequency Characteristics (100Hz)	L-ch	—	(Note 5)	- 2.0	0	2.0	dB
	R-ch						
	L - R						
	Dolby						
Frequency Characteristics (10kHz)	L-ch	—	(Note 6)	- 2.0	0	2.0	dB
	R-ch			- 13.0	- 11.0	- 9.0	
	L - R			- 2.0	0	2.0	
	Dolby			- 7.0	- 6.0	- 5.0	
	L + R						
Balance (Center)		—	(Note 7)	- 2.0	0	2.0	dB
Balance (Max.)	L-ch	—	(Note 8)	1.0	1.9	3.0	dB
	R-ch						
Balance (Min.)	L-ch	—	(Note 9)	—	- 60	- 50	dB
	R-ch						
Filter (Min.)	F Max	—	(Note 10)	1.3	1.6	1.9	kHz
Filter (Min.)	F Min	—	(Note 11)	0.4	0.6	0.8	kHz

TA8776N - 9

1996-09-02

TOSHIBA CORPORATION

CHARACTERISTIC	SYMBOL	TEST CIR-CUIT	TEST CONDITION	MIN.	TYP.	MAX.	UNIT
Treble (Max.)	L-ch	—	(Note 12)	5.0	8.0	10.0	dB
	R-ch						
Treble (Min.)	L-ch	—	(Note 13)	-10.0	-8.0	-5.0	dB
	R-ch						
BASS (Max.)	L-ch	—	(Note 14)	5.0	8.0	10.0	dB
	R-ch						
BASS (Min.)	L-ch	—	(Note 15)	-10.0	-8.0	-5.0	dB
	R-ch						
Mute On Voltage		—	(Note 16)	1.0	1.4	1.8	V
Crosstalk	L-ch → R-ch	—	(Note 17)	50	—	—	dB
	R-ch → L-ch						
	L-ch, R-ch → Dolby			40	—	—	
	Dolby → L-ch						
	Dolby → R-ch						
Dynamic Range (1)	L-ch	—	(Note 18)	5.6	—	—	V _{p-p}
	R-ch						
Dynamic Range (2)	L-ch	—	(Note 19)	4.0	—	—	V _{p-p}
	R-ch						
Dynamic Range (3)	L-ch	—	(Note 20)	1.6	—	—	V _{p-p}
	R-ch						
Dynamic Range (4)	L - R	—	(Note 21)	5.6	—	—	V _{p-p}
	L + R			5.0	—	—	
	Dolby			5.6	—	—	
Surround Switch Offset		—	(Note 22)	—	—	200	mV
Mute DC Offset	L-ch	—	(Note 23)	—	—	600	mV
	R-ch						
	L - R						
	L + R						

TEST CONDITION

NOTE	CHARACTERISTICS	CONDITION									INPUT SIGNAL	MEASUREMENT METHOD
		Bass	Tre	Vol	Lev 1	Lev 2	Bal	Mode	Fill			
		01h	02h	03h	04h	05h	06h	07h	09h			
1	Gain L-ch R-ch L-R Dolby L+R	Cen	Cen	Max	Max	Max	Cen	Off	Min	1kHz, 500mV _{rms}	20log vo / vi	
								Hall				
								Dolby				
								—				
2	THD L-ch R-ch L-R Dolby L+R	Cen	Cen	Max	Max	Max	Cen	Off	Min	1kHz, 500mV _{rms}	Measure THD.	
								Hall		60Hz, 500mV _{rms}		
								Dolby				
								—				
3	S/N L-ch R-ch L-R Dolby L+R	Cen	Cen	Max	Max	Max	Cen	Off	Min	1kHz, 500mV _{rms}	Ref. level : vo with no signal input	
								Hall		60Hz, 500mV _{rms}		
								Dolby				
								—				
4	Surround Phase	Cen	Cen	Max	Max	Max	Cen	Hall	Min	400Hz, 500mV _{rms}	vi-L - R	
5	freq. Response [100Hz] L-ch R-ch L-R Dolby L+R	Cen	Cen	Max	Max	Max	Cen	Off	Min	1kHz / 100Hz, 500mV _{rms}	Ref. : vi (1kHz) Pin 25 : OPEN	
								Hall				
								Dolby				
								—				
6	freq. Response [10kHz] L-ch R-ch L-R Dolby L+R	Cen	Cen	Max	Max	Max	Cen	Off	Min	1kHz / 10kHz, 500mV _{rms}	Ref. : vo (1kHz) Pin 25 : 5600pF to GND	
								Hall				
								Dolby				
								—				
7	Balance Center	Cen	Cen	Max	Max	Max	Cen	Off	Min	1kHz, 500mV _{rms}	20log $\frac{V_{out}(L-ch)}{V_{out}(R-ch)}$	
8	Balance [Max] L-ch R-ch	Cen	Cen	Max	Max	Max	Min	Off	Min	1kHz, 500mV _{rms}	Ref. : Bal Center	
							Max					
9	Balance [Min] L-ch R-ch	Cen	Cen	Max	Max	Max	Max	Off	Min	1kHz, 500mV _{rms}	Ref. : Bal Center	
							Min					
10	Filter [Min]	Min	Min	Max	Max	Max	Cen	Off	Max	0.3~2kHz, 500mV _{rms}	Freq. vo becomes Max	
11	Filter [Max]	Min	Min	Max	Max	Max	Cen	Off	Min	0.3~2kHz, 500mV _{rms}	Freq. vo becomes Max	

TA8776N - 11

1996-09-02

TOSHIBA CORPORATION

NOTE	CHARACTERISTICS	CONDITION									INPUT SIGNAL	MEASUREMENT METHOD
		Bass	Tre	Vol	Lev1	Lev2	Bal	Mode	Fl			
		01h	02h	03h	04h	05h	06h	07h	09h			
12	Treble [Min] L-ch R-ch	Cen	Max	Max	Max	Max	Cen	Off	Min	1kHz / 10kHz, 500mV _{rms}	Ref : vo (1kHz) Treble : Center	
13	Treble [Max] L-ch R-ch	Cen	Min	Max	Max	Max	Cen	Off	Min	1kHz / 10kHz, 500mV _{rms}	Ref. : vo (1kHz) Treble : Center	
14	Bass [Max] L-ch R-ch	Max	Cen	Max	Max	Max	Cen	Off	Min	1kHz / 100Hz, 500mV _{rms}	Ref. : vo (1kHz) Bass : Center	
15	Bass [Min] L-ch R-ch	Min	Cen	Max	Max	Max	Cen	Off	Min	1kHz / 100Hz, 500mV _{rms}	Ref. : vo (1kHz) Bass : Center	
16	Mute On Voltage	Cen	Cen	Max	Max	Max	Cen	Off	Min	1kHz / 500mV _{rms}		
17	Crosstalk L-ch → R-ch R-ch → L-ch L, R-ch → Dolby Dolby → L-ch Dolby → R-ch	Min	Cen	Max	Max	Max	Cen	Off	Min	1kHz / 500mV _{rms}	Ref: L-ch input level Mes: R-ch output level	
											Ref: R-ch input level Mes: L-ch output level	
											Ref: L-ch or R-ch input level Mes: L-R output level	
											Ref: D input level Mes: L-ch output level	
											Ref: D input level Mes: R-ch output level	
18	D Range (1) L-ch R-ch	Cen	Cen	Max	Max	Max	Cen	Off	Adj.	1kHz	Measure input level when THD = 3%.	
19	D Range (2) L-ch R-ch	Max	Max	Max	Max	Max	Cen	Off	Adj.	1kHz	Measure input level when THD = 3%.	
20	D Range (3) L-ch R-ch	Max	Max	Max	Max	Max	Cen	Simulate	Adj.	1kHz	Measure input level when THD = 3%.	
21	D Range (4) L-R L+R Dolby	Cen	Cen	Max	Max	Max	Cen	Hall	Adj.	1kHz	Measure input level when THD = 3%.	
								—				
								Dolby				

NOTE	CHARACTERISTICS	CONDITION									INPUT SIGNAL	MEASUREMENT METHOD
		Bass	Tre	Vol	Lev1	Lev2	Bal	Mode	Fl			
		01h	02h	03h	04h	05h	06h	07h	09h			
22	Surround SW Offset	Cen	Cen	Max	Max	Max	Cen	—	Min	AC GND	Measure offset level between some surround mode and other surround mode	
23	Mute DC Offset L-ch R-ch L-R L+R	Cen	Cen	Max	Max	Max	Cen	Off	Min	AC GND	Measure offset level between muting mode and normal mode	
								Hall				
								—				

APPLICATION EXAMPLE CIRCUIT

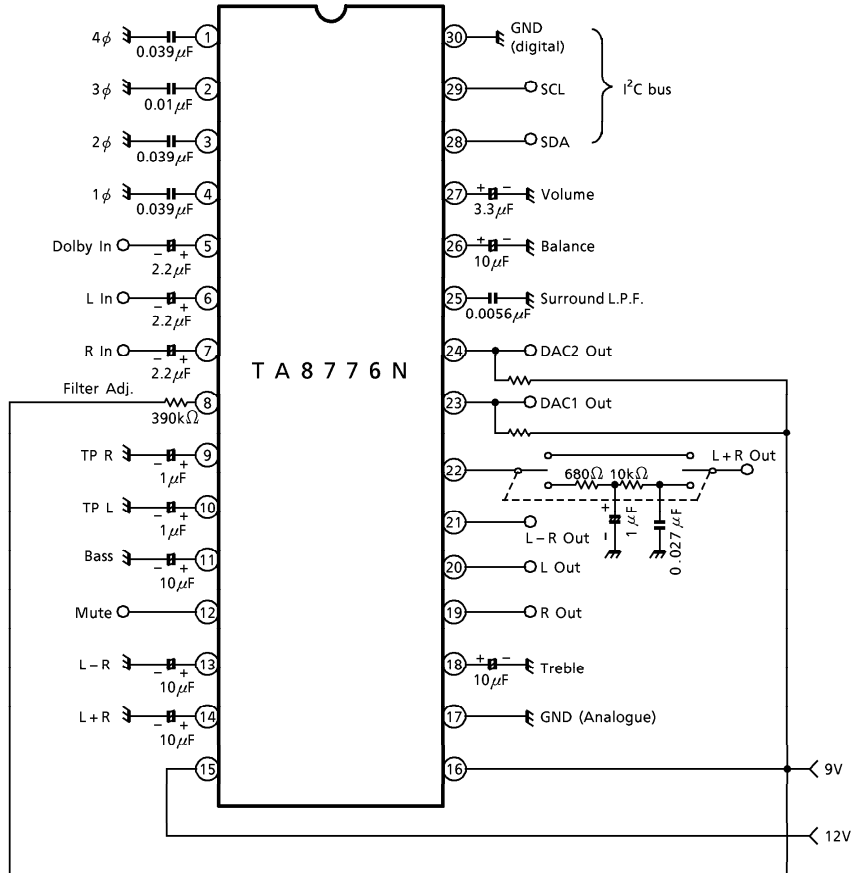

TA8776N - 14

1996-09-02

TOSHIBA CORPORATION

OUTLINE DRAWING
SDIP30-P-400-1.78

Unit : mm

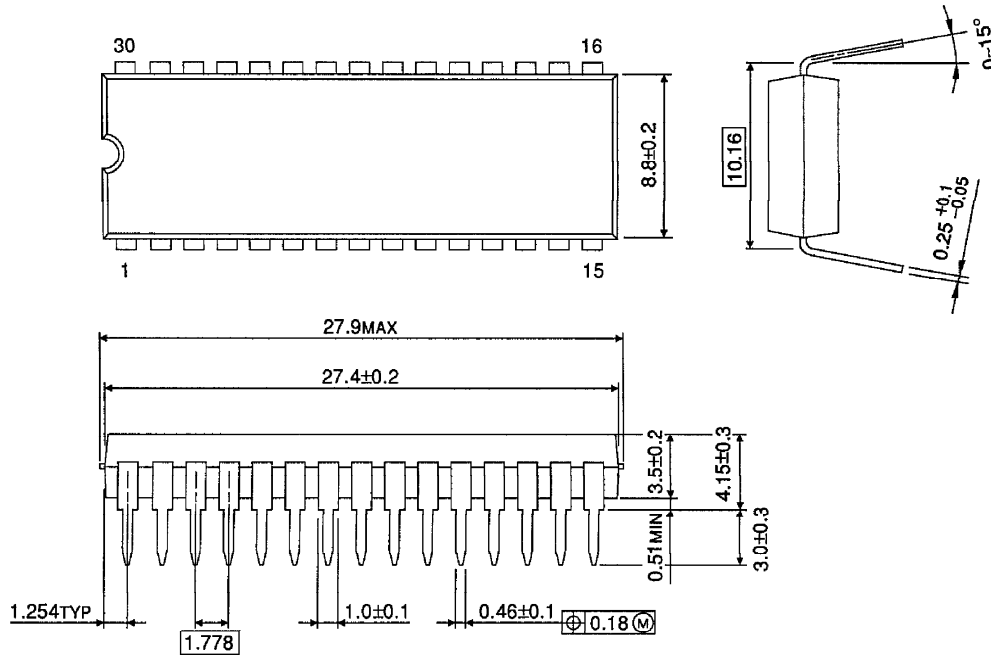

Weight : 1.99g (Typ.)

TA8776N - 15*
1996-09-02
TOSHIBA CORPORATION