

TA8224H

MULTI OUTPUT VOLTAGE REGULATOR FOR CD PLAYER

The TA8224H is voltage regulator IC, designed for compact disc player use, built in 3 outputs and reset circuit.

In addition, protection of over voltage, output to GND short and thermal shut down are involved.

FEATURES

- 3 Regulated Voltage Outputs
 - V_{OUT1} (for μ -com system) fixed voltage output
: $V_{OUT1} = 5\text{ V (Typ.)} / 100\text{ mA (MAX.)}$
 - V_{OUT2} (for servo system) fixed voltage output
: $V_{OUT2} = 5\text{ V (Typ.)} / 300\text{ mA (MAX.)}$
 - V_{OUT3} (for driver) adjustable voltage output
: $V_{OUT3} = 8\text{ V (Typ.)} / 1.2\text{ A (MAX.)}$
- Built-in Reset Circuit 2 input, 1 output
: Reset Sense Voltage $V_R \leq 3.4\text{ V (Ta = 25}^\circ\text{C)}$
- Built-in Stand-by Circuit
: STB1 for V_{OUT1} , V_{OUT2} , V_{OUT3}
: STB2 for V_{OUT2} , V_{OUT3}
- Built-in Various Protection Circuits
: Over Voltage, Output to GND Short, Thermal Shut Down
- Input Operating Voltage Range
: $V_{IN(opr)} = 7.5\sim 20\text{ V}$
: $V_{IN(opr)} = 7.5\sim 24\text{ V (Operating } V_{OUT1} \text{ only)}$

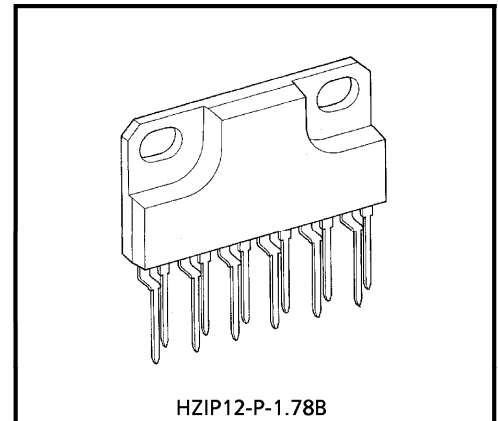

HZIP12-P-1.78B

Weight : 4.04 g (Typ.)

BLOCK DIAGRAM

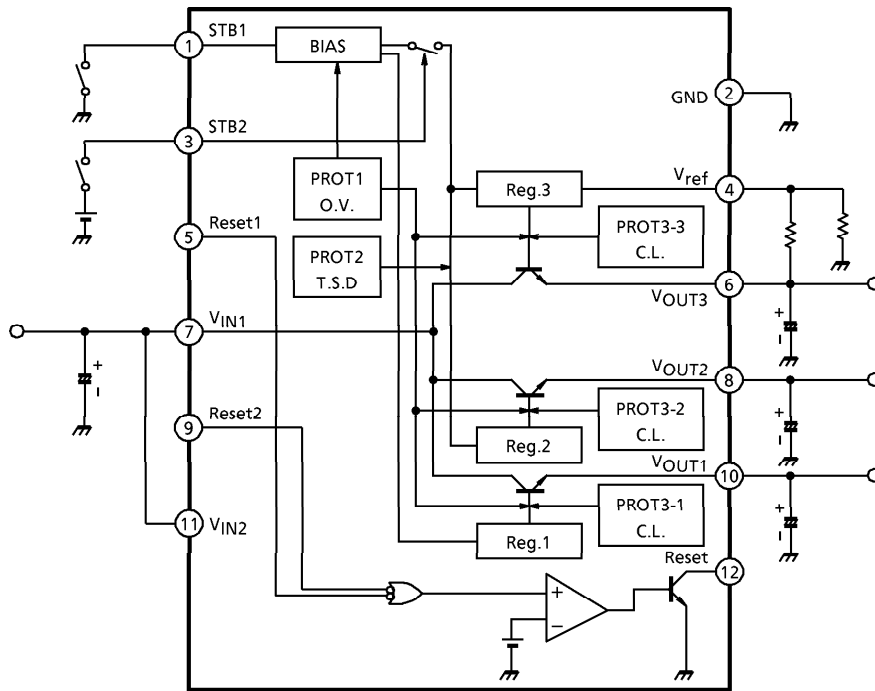

PROT1 : Over Voltage
 PROT2 : Thermal Shut Down
 PROT3 : Current Limiter for Output-GND Short

EXPLANATION FOR EACH TERMINAL

PIN No.	SYMBOL	FUNCTION	REMARKS
1	STB1	Stand-by switch for VOUT1, VOUT2, VOUT3	GND terminal for bias circuit. ① → GND : ON, ① → OPEN : OFF
2	GND	GND	GND is except for bias circuit.
3	STB2	Stand-by switch	$V_{STB2} \geq 3.0V$: ON, $V_{STB2} \leq 1.2V$: OFF
4	Vref	Reference for VOUT3	VOUT3 is decide a ratio of R1 to R2.
5	Reset1	Reset Input 1	$V_{R1} \geq 3.75V$: OFF, $V_{R1} \leq 3.4V$: RESET
6	VOUT3	Adjustable voltage output	Adjust by external resistor R1 and R2
7	VIN1	Input terminal 1	Driver stage supply terminal
8	VOUT2	5 V output	Output fixed 5 V.
9	Reset2	Reset input 2	$V_{R2} \geq 3.75V$: OFF, $V_{R2} \leq 3.4V$: RESET
10	VOUT1	5 V output	Output fixed 5 V.
11	VIN2	Input 2	Pre stage supply terminal
12	Reset	Reset output	Open collector

MAXIMUM RATINGS (Ta = 25°C)

CHARACTERISTIC	SYMBOL	RATING	UNIT
DC Input Voltage	V _{CC}	30	V
Power Dissipation	P _D (Note)	25	W
Operating Temperature	T _{opr}	- 25~75	°C
Storage Temperature	T _{stg}	- 55~150	°C

(Note) Derated above Ta = 25°C in the proportion of 200 mW/°C.

ELECTRICAL CHARACTERISTICS

(Unless otherwise specified, $V_{IN} = 12\text{ V}$, $I_{OUT1} = 100\text{ mA}$, $I_{OUT2} = 300\text{ mA}$, $I_{OUT3} = 300\text{ mA}$, $T_a = 25^\circ\text{C}$)

CHARACTERISTIC	SYMBOL	TEST CIRCUIT	TEST CONDITION	MIN.	TYP.	MAX.	UNIT	
Output Voltage	V_{OUT1}	—	—	4.8	5.0	5.3	V	
	V_{OUT2}	—	—	4.8	5.0	5.3		
	V_{OUT3}	—	$R_1 = 18\text{ k}\Omega$, $R_2 = 39\text{ k}\Omega$	7.7	8.0	8.3		
Input Regulation	Reg1. line	—	$7.5\text{ V} \leq V_{IN} \leq 24\text{ V}$	—	20	100	mV	
	Reg2. line	—	$7.5\text{ V} \leq V_{IN} \leq 20\text{ V}$	—	20	100		
	Reg3. line	—	$10.3\text{ V} \leq V_{IN} \leq 20\text{ V}$	—	20	150		
Load Regulation	Reg1. load	—	$0\text{ mA} \leq I_{OUT1} \leq 100\text{ mA}$	—	20	100	mV	
	Reg2. load	—	$5\text{ mA} \leq I_{OUT2} \leq 300\text{ mA}$	—	20	100		
	Reg3. load	—	$5\text{ mA} \leq I_{OUT3} \leq 300\text{ mA}$ $5\text{ mA} \leq I_{OUT3} \leq 1.2\text{ A}$	—	20	100		
Ripple Rejection Ratio	R.R.1	—	$V_{in} = 1\text{ V}_{rms}$ $f = 120\text{ Hz}$	$10\text{ V} \leq V_{IN} \leq 24\text{ V}$	60	70	dB	
	R.R.2	—		$11\text{ V} \leq V_{IN} \leq 20\text{ V}$	60	70		
	R.R.3	—		$12\text{ V} \leq V_{IN} \leq 20\text{ V}$	52	64		
Dropout Voltage	V_{D1}	—	$V_{IN} = 6\text{ V}$	—	1.8	—	V	
	V_{D2}	—	$V_{IN} = 6\text{ V}$	—	1.8	—		
	V_{D3}	—	$V_{IN} = 8\text{ V}$	—	1.5	—		
Maximum Output Current	I_{MAX1}	—	—	100	200	—	mA	
	I_{MAX2}	—		300	400	—		
	I_{MAX3}	—		1.2	1.5	—		A
Output Short Current	I_{SC1}	—	—	—	250	—	mA	
	I_{SC2}	—		—	400	—		
	I_{SC3}	—		—	1.0	—		A
Output Noise Voltage	V_{no1}	—	—	—	180	—	μV	
	V_{no2}	—		—	230	—		
	V_{no3}	—		—	260	—		
Output Voltage Temperature Coefficient	T_{CVO1}	—	—	—	0.5	—	mV/°C	
	T_{CVO2}	—		—	-1.1	—		
	T_{CVO3}	—		—	-1.2	—		
Bias Current	I_B	—	$I_{OUT1}=0\text{ mA}$, $V_{OUT2, 3}\text{-OFF}$	—	0.6	1.2	mA	
Reset	Reset Sense Voltage	V_R	—	3.4	—	3.75	V	
	Hysteresis Voltage	ΔV_H	—	—	60	—	mV	
	Output Saturation Voltage	V_{sat}	—	$R_3 = 510\ \Omega$	—	0.3	1.0	V
	Sensing Voltage Temperature Coefficient	$T_c\ VO4$	—	—	—	0.5	—	mV/°C
Stand-by Current	I_{lstb}	—	$V_1 = 0\text{ V}$, $V_{OUT2, 3}\text{-OFF}$	—	180	300	μA	
Threshold Voltage	V_{Sstb2}	—	—	1.2	—	3.0	V	

TEST CIRCUIT

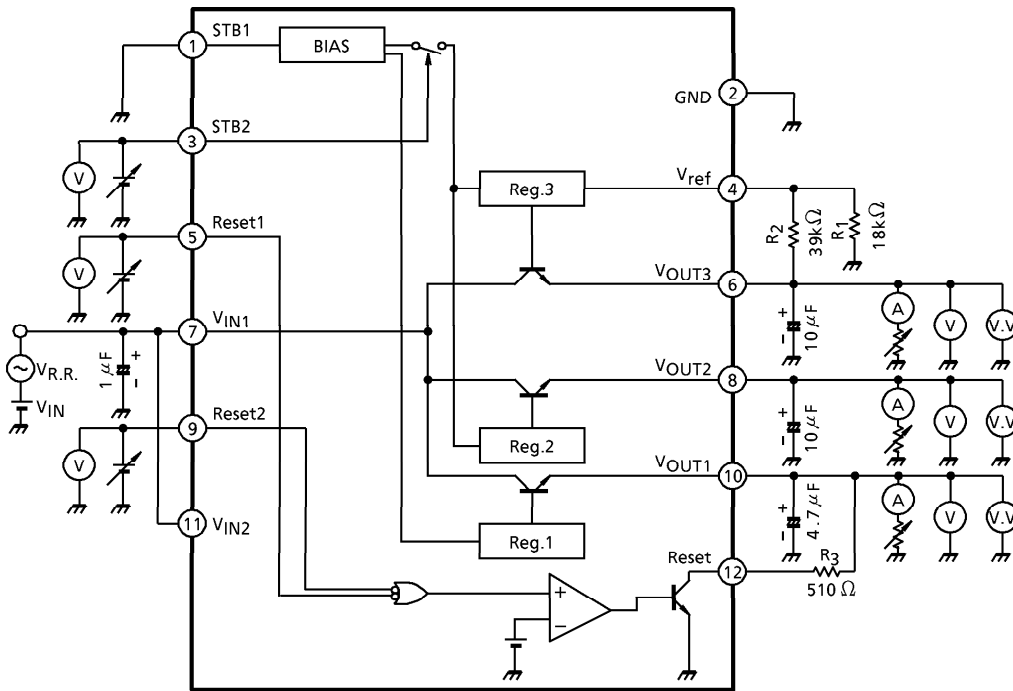

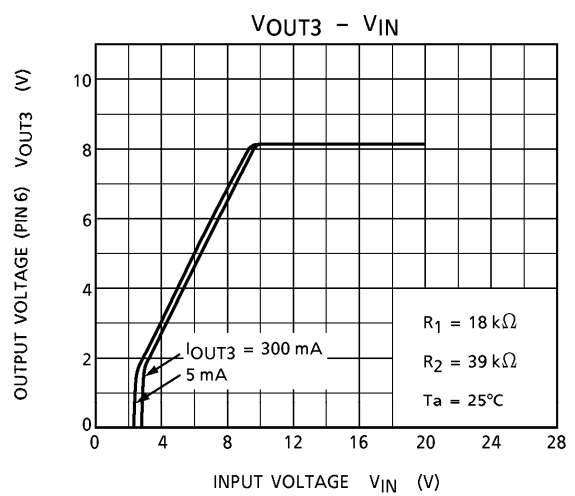
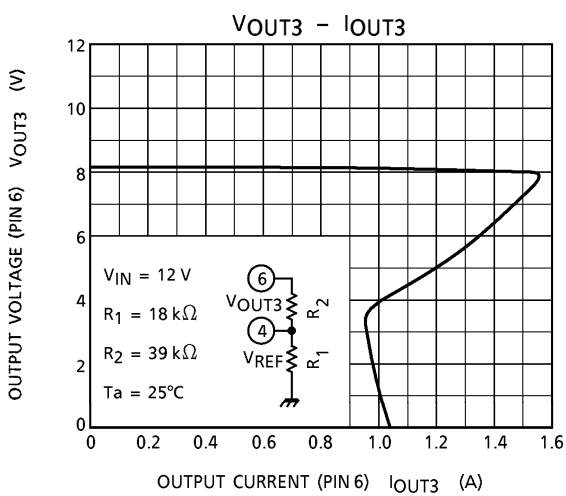
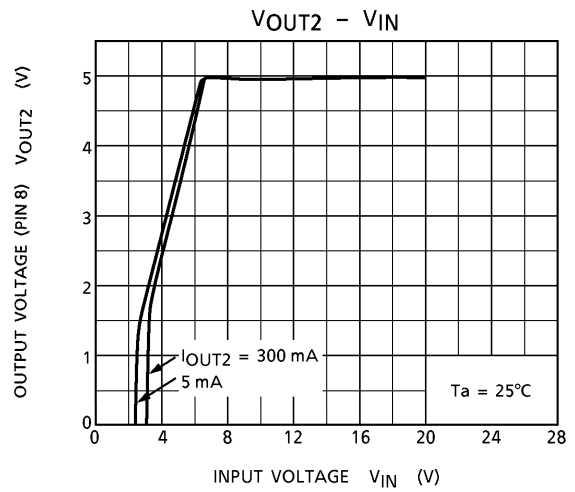
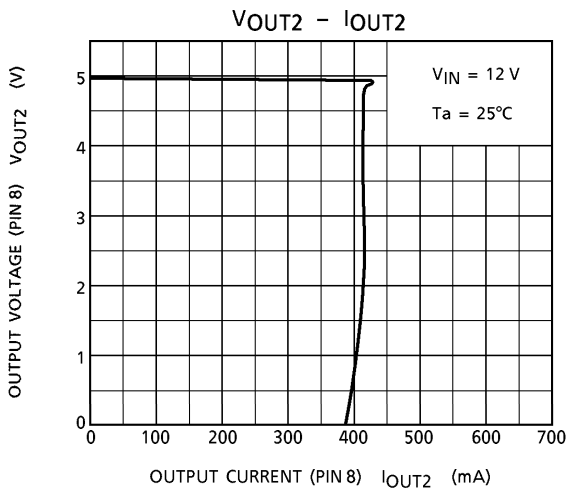
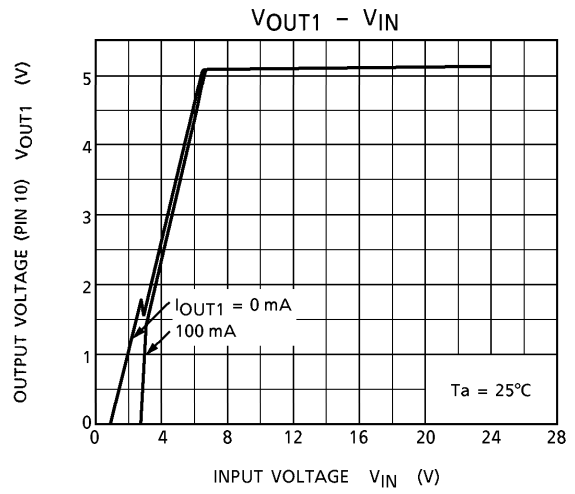
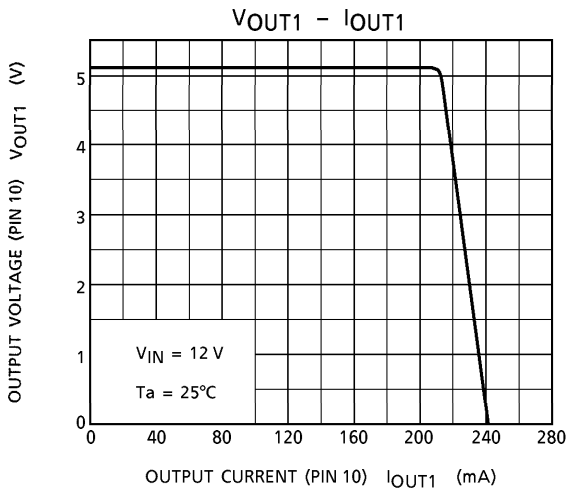

R.R.1 - I_{OUT1}

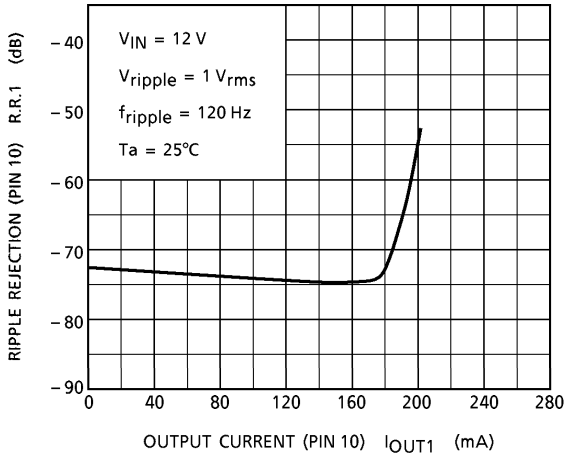

R.R.1 - V_{IN}

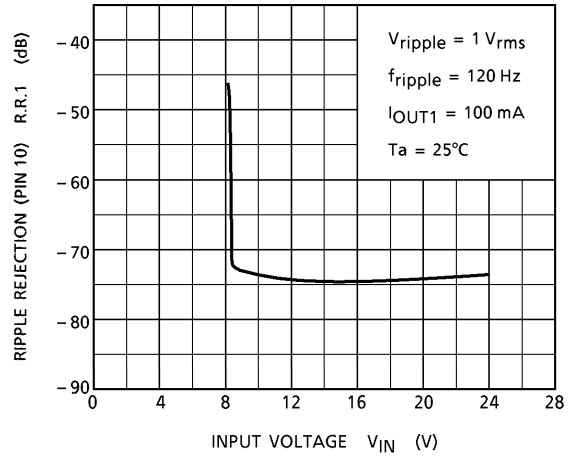

R.R.2 - I_{OUT2}

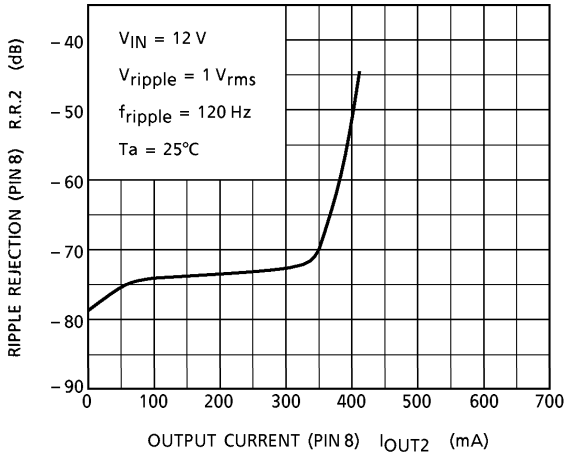

R.R.2 - V_{IN}

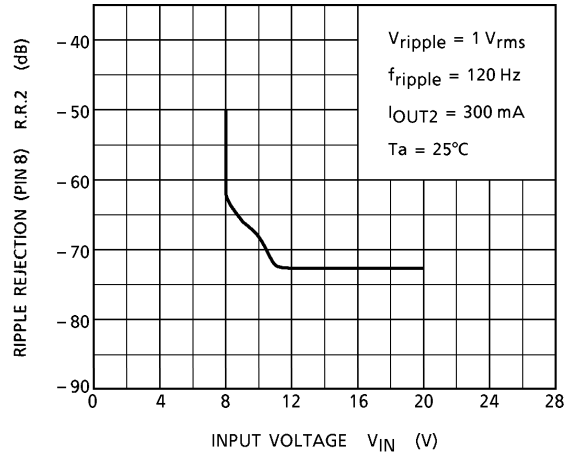

R.R.3 - I_{OUT3}

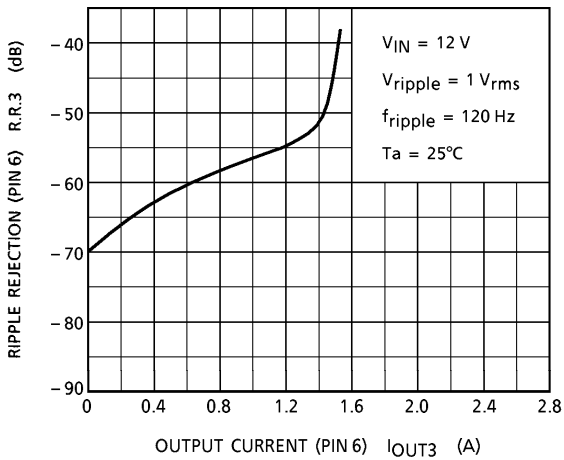

R.R.3 - V_{IN}

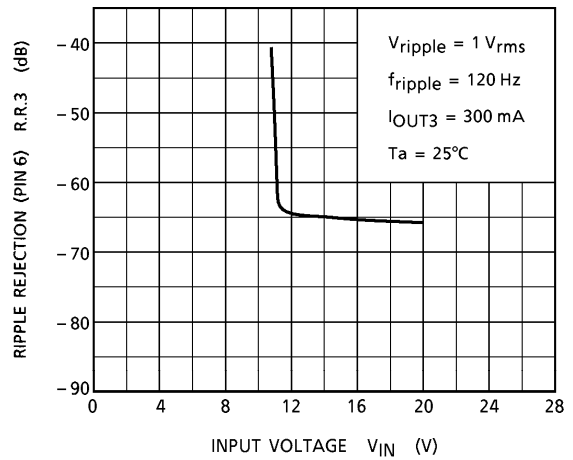

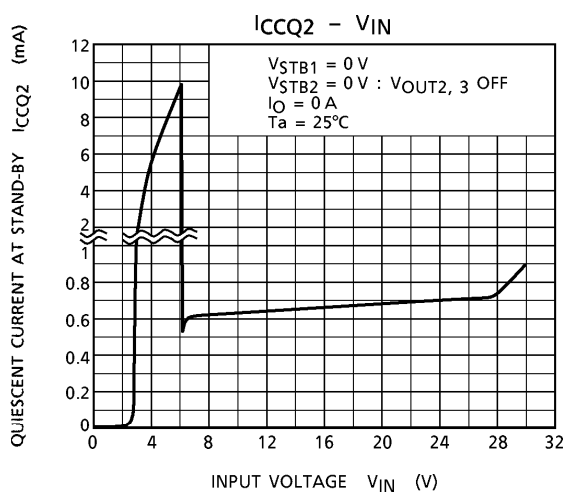
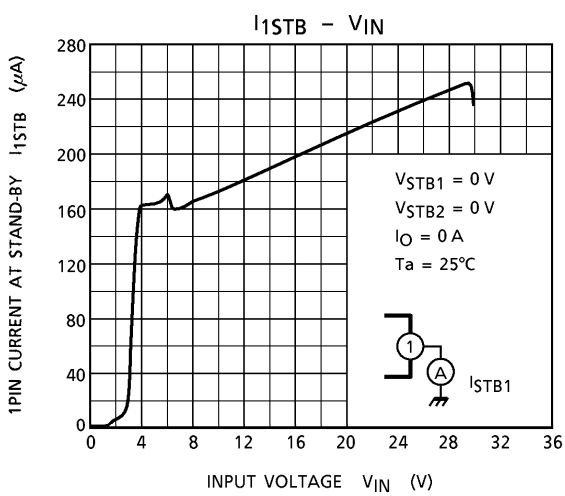
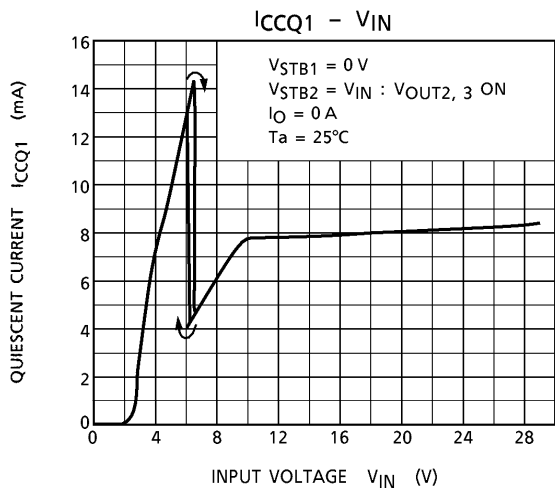
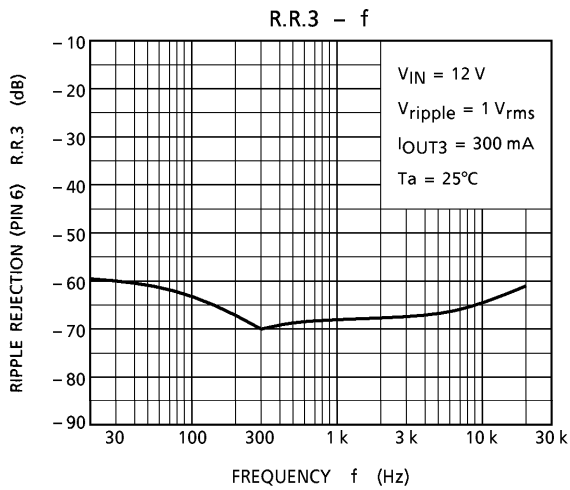
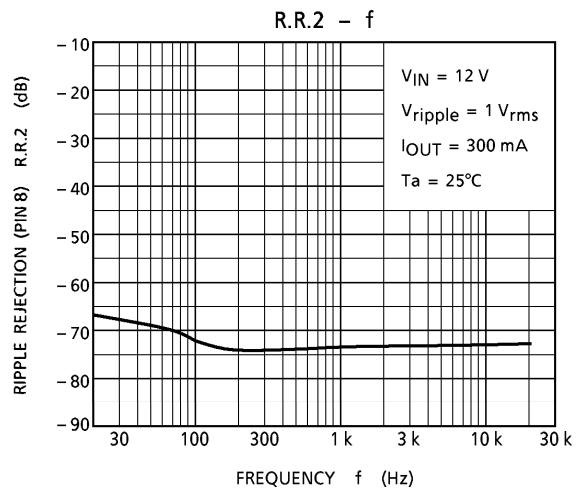
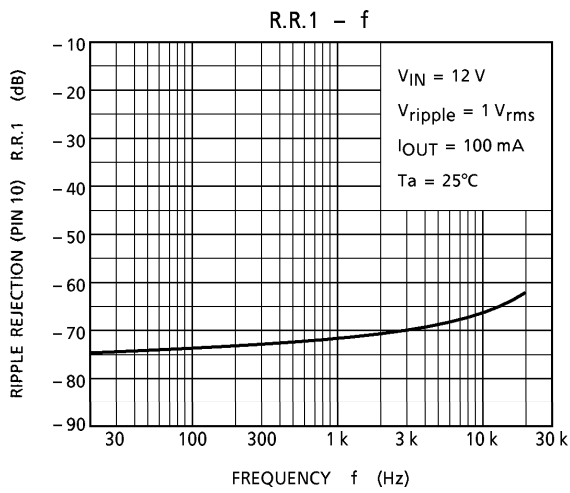

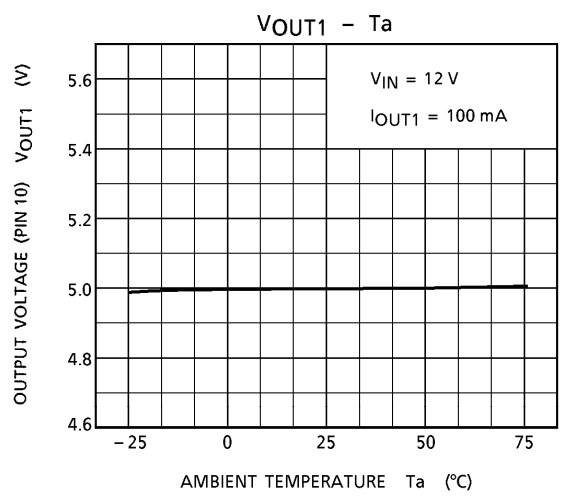
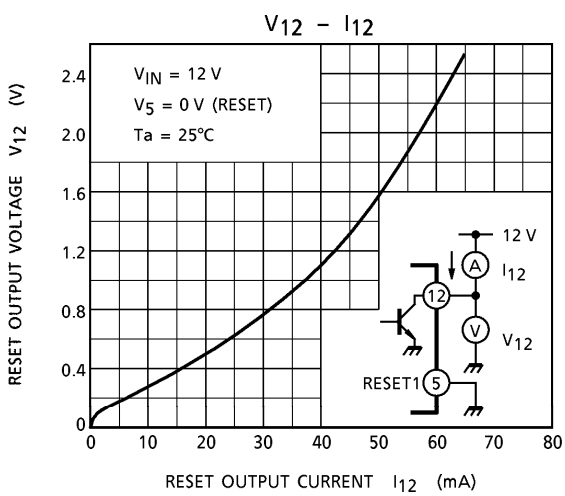
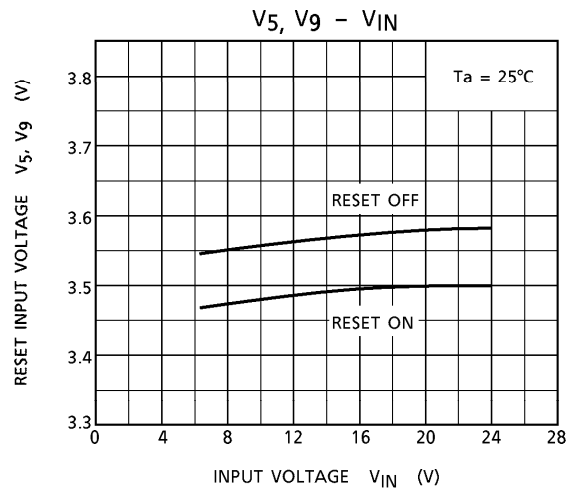
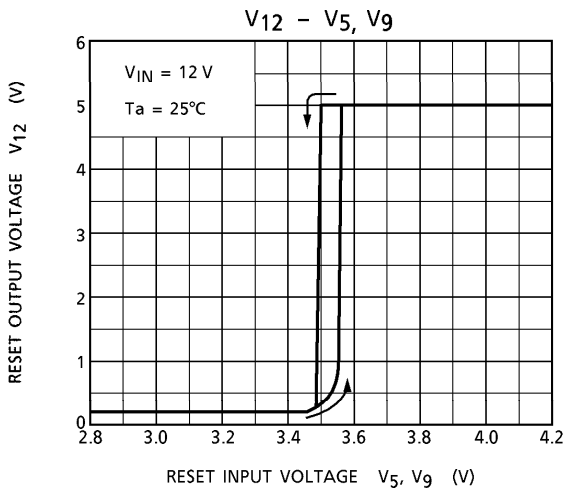
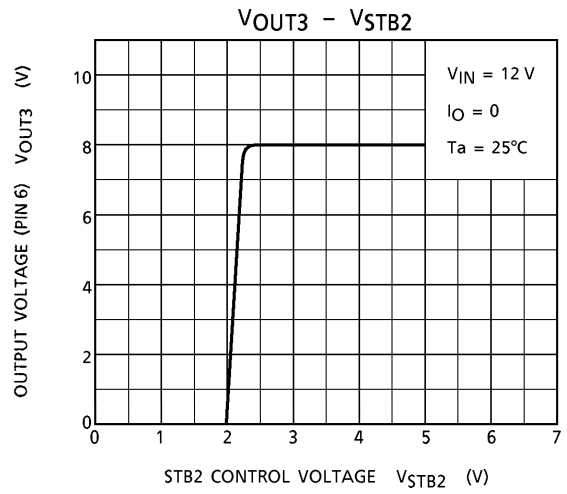
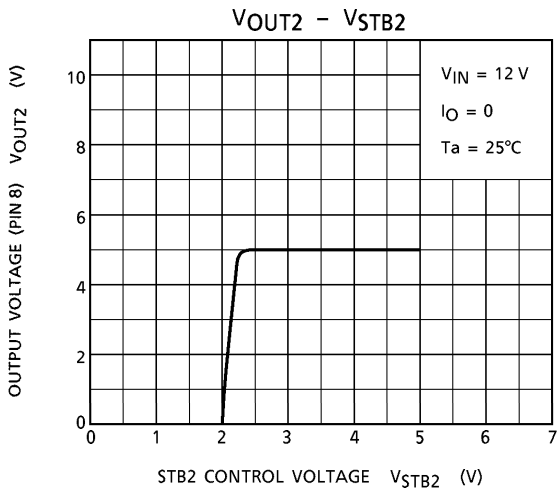

V_{OUT2} - T_a

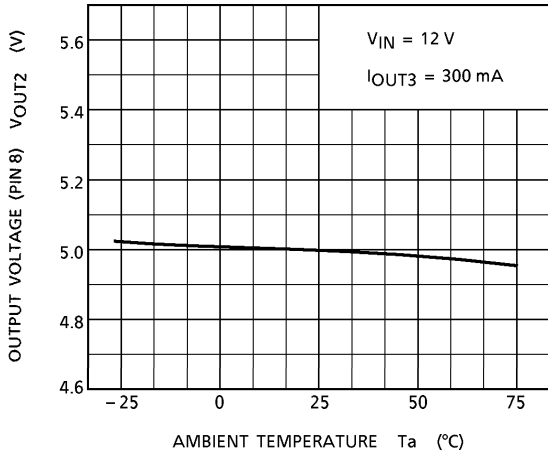

V_{OUT3} - T_a

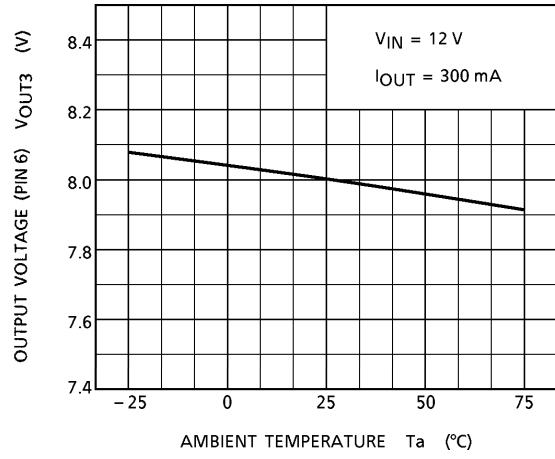

V_{STB2} - T_a

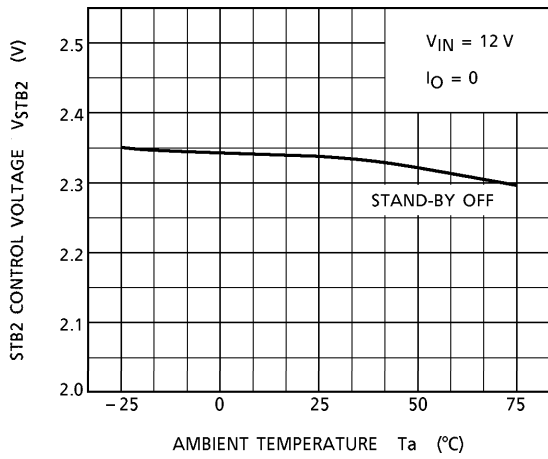

V₅, V₉ - T_a

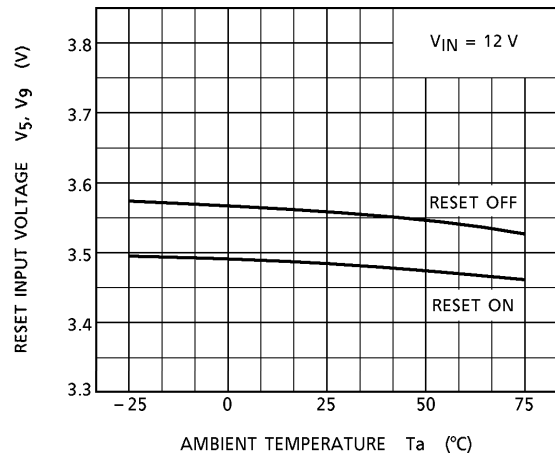

APPLICATION CIRCUIT

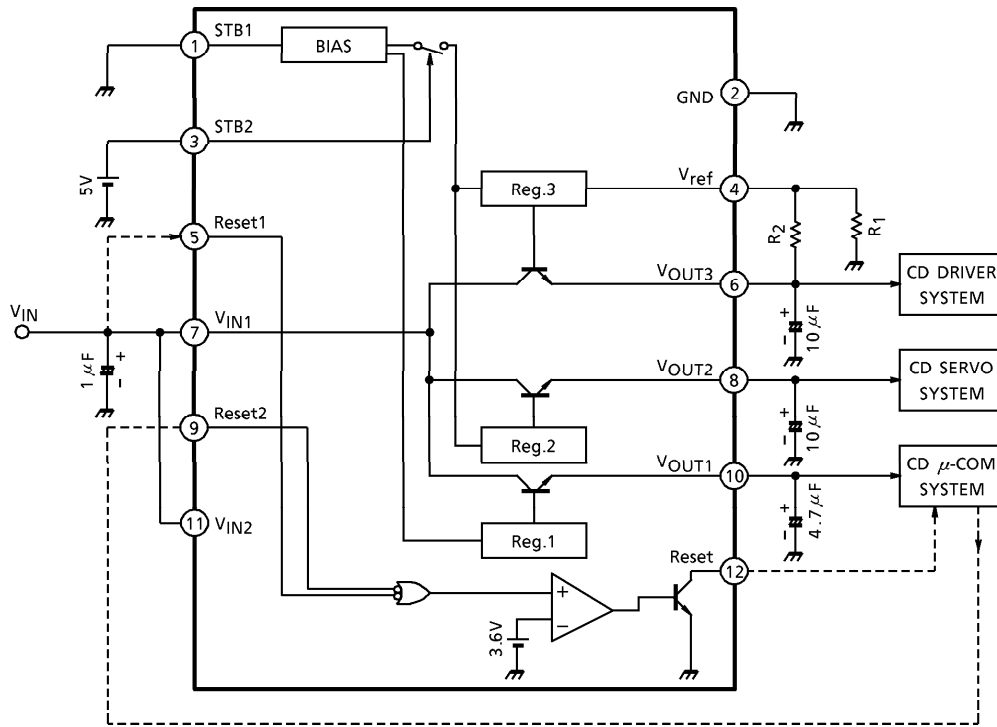

PACKAGE DIMENSIONS
HZIP12-P-1.78B

Unit : mm

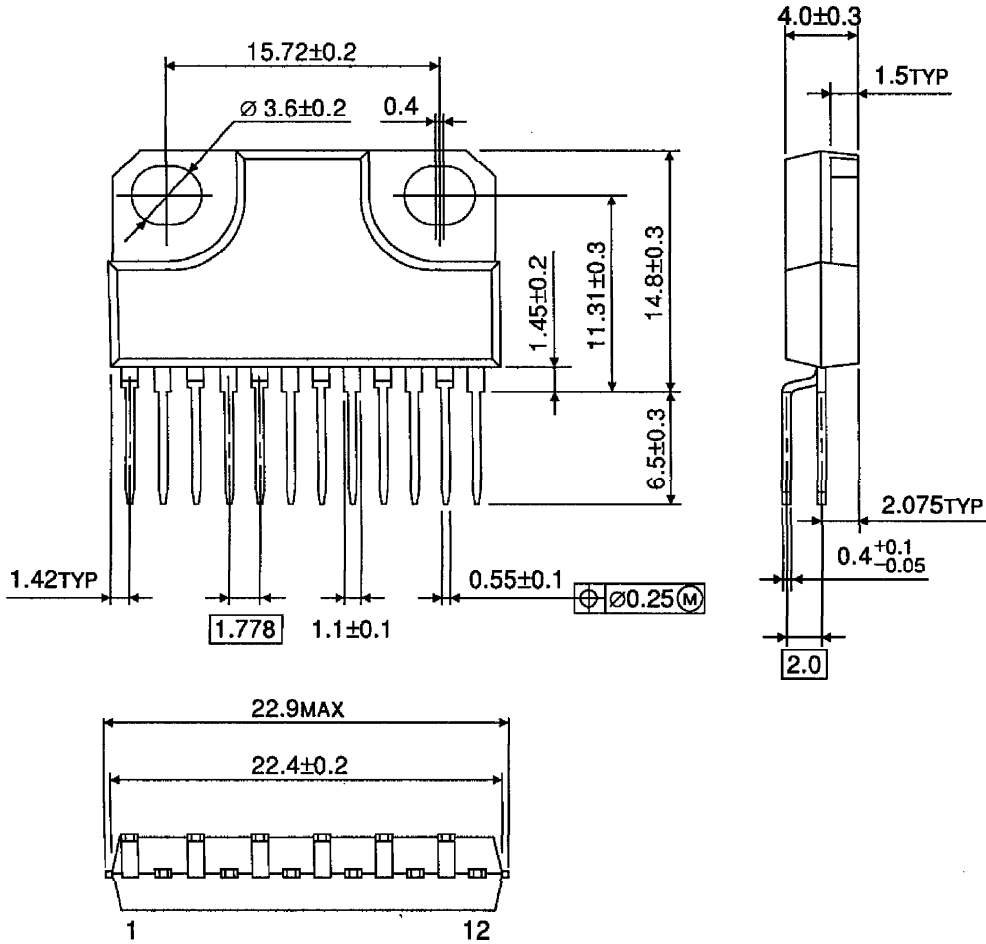

Weight : 4.04 g (Typ.)

RESTRICTIONS ON PRODUCT USE

000707EBA

- TOSHIBA is continually working to improve the quality and reliability of its products. Nevertheless, semiconductor devices in general can malfunction or fail due to their inherent electrical sensitivity and vulnerability to physical stress. It is the responsibility of the buyer, when utilizing TOSHIBA products, to comply with the standards of safety in making a safe design for the entire system, and to avoid situations in which a malfunction or failure of such TOSHIBA products could cause loss of human life, bodily injury or damage to property. In developing your designs, please ensure that TOSHIBA products are used within specified operating ranges as set forth in the most recent TOSHIBA products specifications. Also, please keep in mind the precautions and conditions set forth in the "Handling Guide for Semiconductor Devices," or "TOSHIBA Semiconductor Reliability Handbook" etc..
- The TOSHIBA products listed in this document are intended for usage in general electronics applications (computer, personal equipment, office equipment, measuring equipment, industrial robotics, domestic appliances, etc.). These TOSHIBA products are neither intended nor warranted for usage in equipment that requires extraordinarily high quality and/or reliability or a malfunction or failure of which may cause loss of human life or bodily injury ("Unintended Usage"). Unintended Usage include atomic energy control instruments, airplane or spaceship instruments, transportation instruments, traffic signal instruments, combustion control instruments, medical instruments, all types of safety devices, etc.. Unintended Usage of TOSHIBA products listed in this document shall be made at the customer's own risk.
- The products described in this document are subject to the foreign exchange and foreign trade laws.
- The information contained herein is presented only as a guide for the applications of our products. No responsibility is assumed by TOSHIBA CORPORATION for any infringements of intellectual property or other rights of the third parties which may result from its use. No license is granted by implication or otherwise under any intellectual property or other rights of TOSHIBA CORPORATION or others.
- The information contained herein is subject to change without notice.