

TOSHIBA BIPOLAR LINEAR INTEGRATED CIRCUIT SILICON MONOLITHIC

TA8187AFN

1.5V DUAL FM IF

The TA8187AFN is dual FM IF system IC, developed for headphone stereo etc.

It is built in dual FM IF systems, dual buffer amplifiers and soft muting function etc.

FEATURES

- Built-in dual FM IF systems
- Built-in dual buffer amplifiers
- Built-in soft muting function (only dual IF mode)
ATT = 21dB (Typ.)
- Low supply current ($V_{CC} = 1.2V$, $T_a = 25^\circ C$)
Single IF mode : 2.8mA (Typ.)
Dual IF mode : 3.2mA (Typ.)
- Built-in mode switch
- Output of buffer amplifier is high-impedance in power off mode.
- Operating supply voltage range (Typ.)
 $V_{CC} (opr) = 0.95 \sim 2.2V$

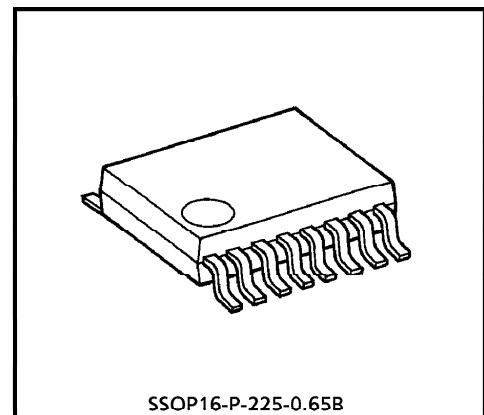

SSOP16-P-225-0.65B
Weight : 0.09g (Typ.)

BLOCK DIAGRAM

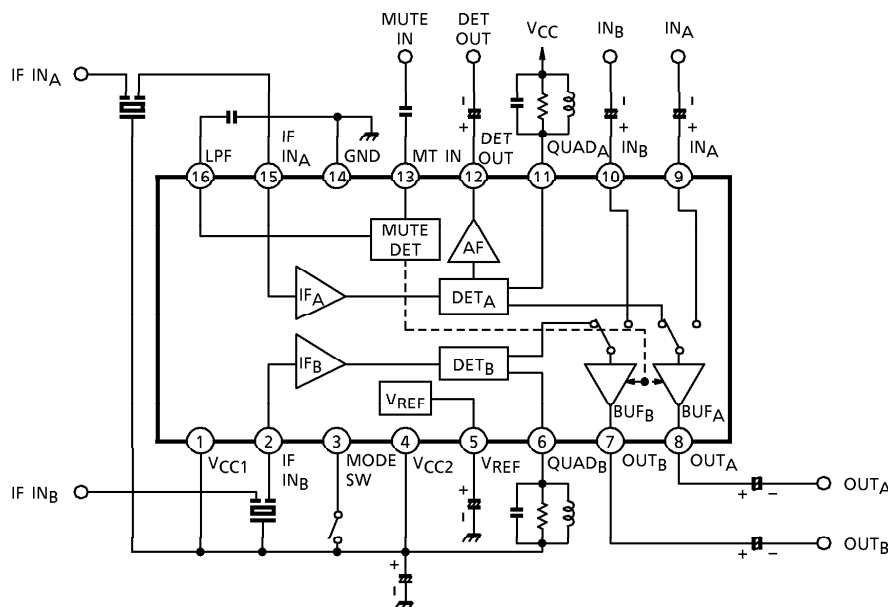

961001EBA2

● TOSHIBA is continually working to improve the quality and the reliability of its products. Nevertheless, semiconductor devices in general can malfunction or fail due to their inherent electrical sensitivity and vulnerability to physical stress. It is the responsibility of the buyer, when utilizing TOSHIBA products, to observe standards of safety, and to avoid situations in which a malfunction or failure of a TOSHIBA product could cause loss of human life, bodily injury or damage to property. In developing your designs, please ensure that TOSHIBA products are used within specified operating ranges as set forth in the most recent products specifications. Also, please keep in mind the precautions and conditions set forth in the TOSHIBA Semiconductor Reliability Handbook.

TERMINAL EXPLANATION

Terminal voltage : Typical terminal voltage with test circuit ($V_{CC} = 1.2V, T_a = 25^\circ C$)

TERMI- NAL No.	NAME	FUNCTION	INTERNAL CIRCUIT	TERMINAL VOLTAGE (V)
1	VCC1	VCC, for IF amplifier		1.2
2	IF IN _B	Input of IF amplifier ● Input impedance : 330Ω (Typ.)		1.2
15	IF IN _A			
3	MODE SW	Mode switch (VCC : Single IF mode GND / OPEN : Dual IF mode)		—
4	VCC2	VCC, except VCC1	—	1.2
5	VREF	Reference circuit		0.75
6	QUAD _B	QUAD detector circuit ● DET coil should be connected with VCC.		1.2
11	QUAD _A			
7	OUT _B	Output of audio signal ● Output impedance : 1kΩ (Typ.)		0.6
8	OUT _A			
12	DET OUT	Detector output ● This output level is recovered output voltage of the signal is applied to the terminal of IF IN _A . It isn't under the influence of mode switch condition. ● Output impedance : 1kΩ (Typ.)		0.6

961001EBA2'

- The products described in this document are subject to foreign exchange and foreign trade control laws.
- The information contained herein is presented only as a guide for the applications of our products. No responsibility is assumed by TOSHIBA CORPORATION for any infringements of intellectual property or other rights of the third parties which may result from its use. No license is granted by implication or otherwise under any intellectual property or other rights of TOSHIBA CORPORATION or others.
- The information contained herein is subject to change without notice.

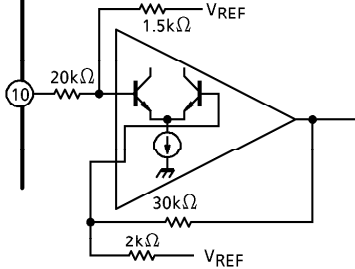
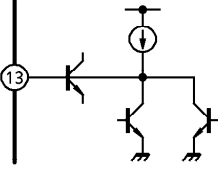
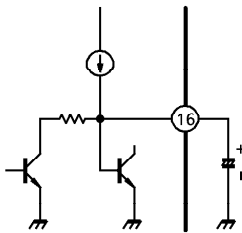
TERMI- NAL No.	NAME	FUNCTION	INTERNAL CIRCUIT	TERMINAL VOLTAGE (V)
9	IN _A	Input of audio signal ● Input impedance : 21.5kΩ (Typ.)		0.75
10	IN _B			
13	MT IN	Input of muting signal		0.7
14	GND	—	—	0
16	LPF	Smoothing circuit of soft muting		0.7

APPLICATION NOTE

1. MODE SW (pin③)

- It is necessary to connect an external pull-down resistor with the terminal of MODE SW (pin③), in case that this IC mode doesn't operate normally due to external noise etc.
- Reducing a pop sound
It is advised to connect R1, R2 and C with the terminal of MODE SW (pin③), to reduce a pop sound is switchover between single IF mode and dual IF mode (see Fig.1). It is better that the constants are $R1 \cong R2 \cong 100k\Omega$, $C \cong 1\mu F$ at $V_{CC} = 1.2V$. As for the constants, select the optimum one depending on each a set carefully.
- Operating amplifier etc. is decided by condition of mode switch. It is as follows.

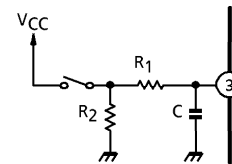

Fig.1 Mode switch circuit reducing a pop sound

	INPUT TERMINAL	OUTPUT TERMINAL	OPERATING AMP.
Dual IF mode	IF IN _A (pin⑮)	OUT _A (pin⑧) DET OUT (pin⑫)	IF _A , BUF _A AF
	IF IN _B (pin②)	OUT _B (pin⑦)	IF _B , BUF _B
Single IF mode	IF IN _A (pin⑮)	DET OUT (pin⑫)	IF _A , AF
	IN _A (pin⑨)	OUT _A (pin⑧)	BUF _A
	IN _B (pin⑩)	OUT _B (pin⑦)	BUF _B

Table 1 Operating amplifier etc. by mode switch condition

2. IF IN (pin②⑮)

External parts (ceramic filter etc.) of IF amplifier should be connected V_{CC1} terminal with common terminal of external parts, because IF amplifier circuits operate on V_{CC1} voltage. In case that these external parts are connected with GND reference etc., there is a possibility that this circuit doesn't operate normally at large signal input.

4. In case that the muting function isn't used.

In case that the muting function isn't used, the terminal of MT IN (pin^⑬) and LPF (pin^⑯) should be opened. In case that these terminal connected with V_{CC} or GND, internal circuit doesn't operate normally.

It is necessary to connect an external capacitor (C=0.01 μ F) with the terminal of MT IN (pin^⑬) and LPF (pin^⑯), in case that the muting function operates due to external noise etc.

5. INPUT OF AUDIO SIGNAL

The audio signal should be applied to the terminal of IN_A (pin^⑨) or IN_B (pin^⑩) through a coupling capacitor because buffer amplifier is operated by V_{REF}.

In case that DC current or DC voltage is applied to the terminal of IN_A (pin^⑨) or IN_B (pin^⑩), the internal circuit has unbalance and buffer amplifier doesn't operate normally.

ELECTRICAL CHARACTERISTICS

(Unless otherwise specified, $V_{CC} = 1.2V$, $T_a = 25^\circ C$
 FM IF / MUTING STAGE $f = 10.7MHz$, $f_m = 1kHz$, $\Delta f = \pm 22.5kHz$, $V_{in} = 80dB_{\mu V}$ EMF, SW : a)
 AUDIO STAGE $f = 1kHz$, $R_L = 10k\Omega$, SW : b

CHARACTERISTIC	SYMBOL	TEST CIRCUIT	TEST CONDITION	MIN.	TYP.	MAX.	UNIT
Supply Current 1	I _{CC1}	—	Single IF mode, $V_{in} = 0$, SW : b	—	2.8	4.2	mA
Supply Current 2	I _{CC2}	—	Dual IF mode, $V_{in} = 0$, SW : a	—	3.2	4.8	mA
Reference Voltage	V _{REF}	—		0.65	0.75	0.85	V
FM IF Stage	Recovered Output Voltage 1	V _{OD1}	—		30	45	65 mV _{rms}
	V _{OD} Channel Balance	CB1	—		-2	0	+2 dB
	Recovered Output Voltage 2	V _{OD2}	—		—	45	— mV _{rms}
	Input Limiting Voltage	V _{in (lim)}	—	-3dB limiting point	—	54	59 dB _{μV} EMF
	V _{in (lim)} Channel Balance	CB2	—		—	0	— dB
	Total Harmonic Distortion 1	THD1	—		—	0.2	— %
	Signal to Noise Ratio 1	S / N1	—	$\Delta f = \pm 22.5kHz \rightarrow 0$	—	58	— dB
	AM Rejection Ratio	AMR	—	MOD = 30%	—	36	— dB
	Cross Talk	CT1	—		—	53	— dB
	Recovered Output Voltage 3	V _{OD3}	—		30	45	65 mV _{rms}
	Total Harmonic Distortion 2	THD2	—		—	0.2	— %
	Signal to Noise Ratio 2	S / N2	—	$\Delta f = \pm 22.5kHz \rightarrow 0$	—	58	— dB
	Audio Amplifier Attenuation	ATT1	—	$V_o = -22dBV$, SW : b→a	—	62	— dB
Audio Stage	Voltage Gain	G _V	—	$V_o = -22dBV$	-2.3	-0.3	+1.7 dB
	G _V Channel Balance	CB3	—	$V_o = -22dBV$	-2	0	+2 dB
	Maximum Output Voltage	V _{om}	—	THD = 1%	180	310	— mV _{rms}
	Total Harmonic Distortion	THD3	—	$V_o = -22dBV$	—	0.1	— %
	Cross Talk	CT2	—	$V_o = -22dBV$	—	74	— dB
	Output Noise Voltage	V _{no}	—	$R_g = 600\Omega$, BW = 20Hz~20kHz	—	14	— μV_{rms}
	FM IF Attenuation	ATT2	—	0dB = V _{OD} level, SW : a→b	—	70	— dB

CHARACTERISTIC		SYMBOL	TEST CIRCUIT	TEST CONDITION	MIN.	TYP.	MAX.	UNIT	
Muting Stage	Muting Off Voltage	MT (OFF)	—	f = 60kHz, V _{OD} > 3dB	—	—	30	mV _{rms}	
	Muting On Voltage	MT (ON)	—	f = 60kHz, V _{OD} < 15dB	90	—	—	mV _{rms}	
	Muting Attenuation	ATT3	—		—	21	—	dB	
Single IF Mode On Current		I ₃	—	V _{CC} = 0.95V	V _o > -42dBV		5	—	μA
Dual IF Mode On Voltage		V ₃	—	V _{in} = -32dBV	V _o < -52dBV		0	—	V

TEST CIRCUIT

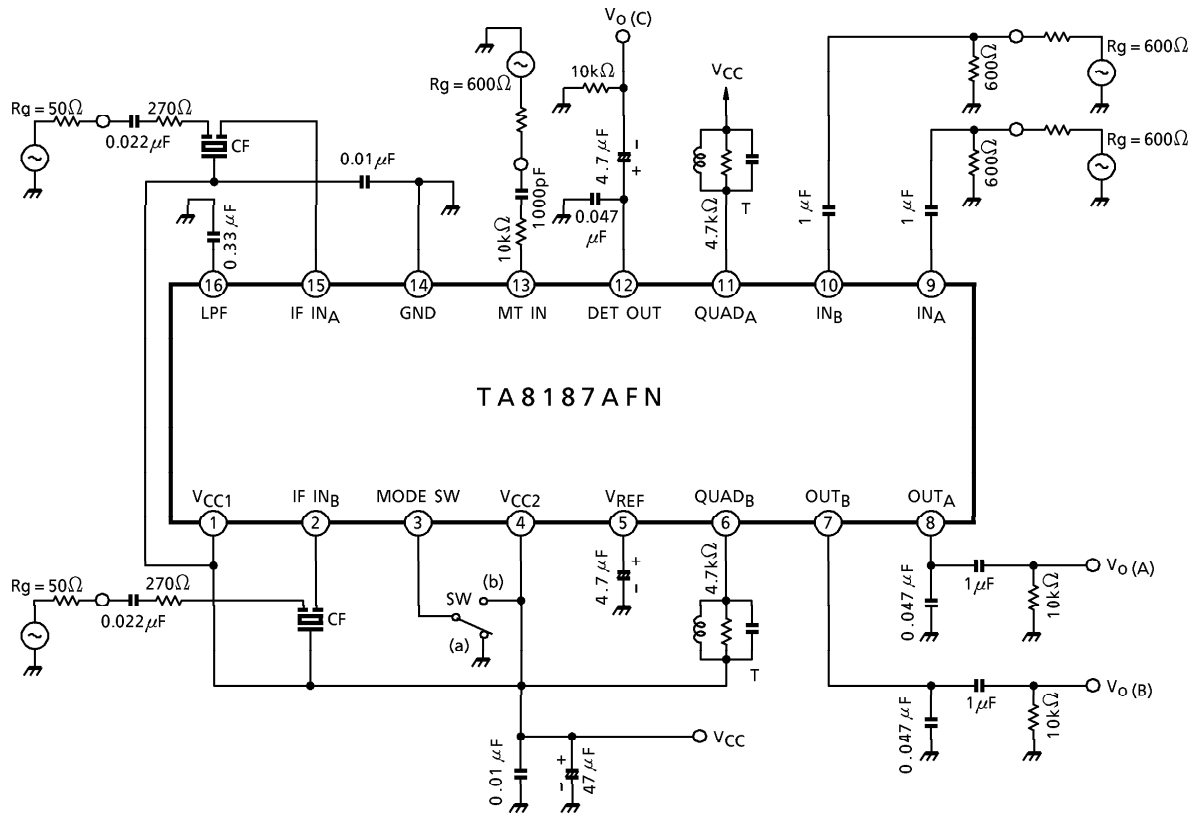

CF : SFE10.7MA5-A (MURATA)

COIL DATA : T

TEST FREQUENCY	C ₀ (pF)	Q ₀	TURN	WIRE (mm φ)	REFERENCE
			1-3		
10.7MHz	82	60	13	0.07UEW	4162-080 SUMIDA ELECTRIC Co., Ltd.

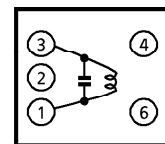

(Bottom of view)

CHARACTERISTIC CURVES

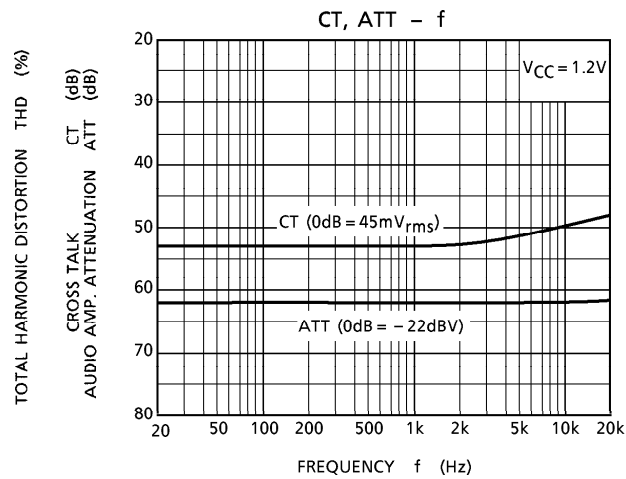
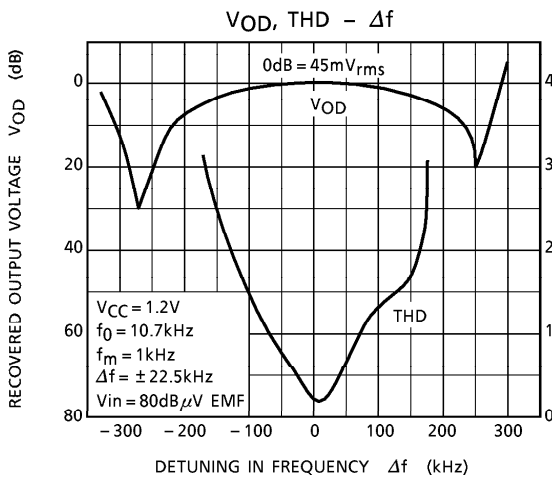
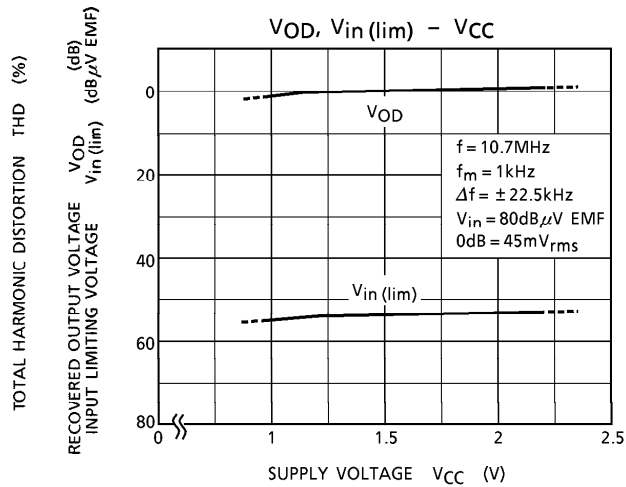
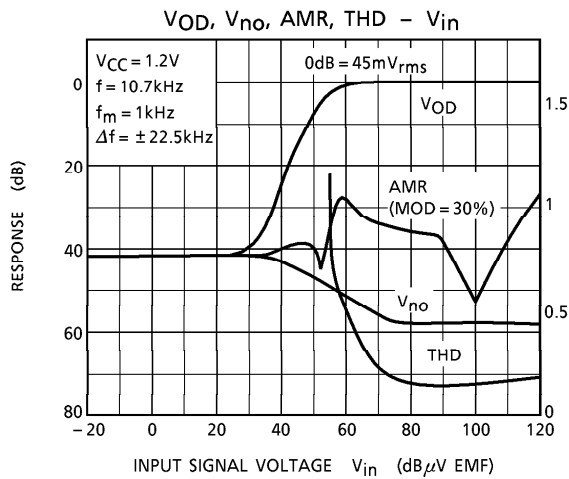
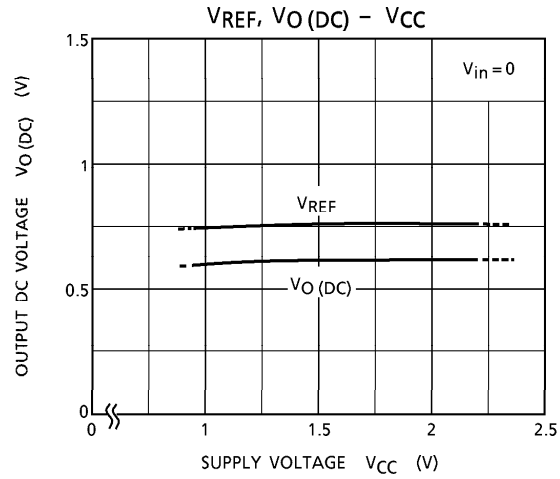
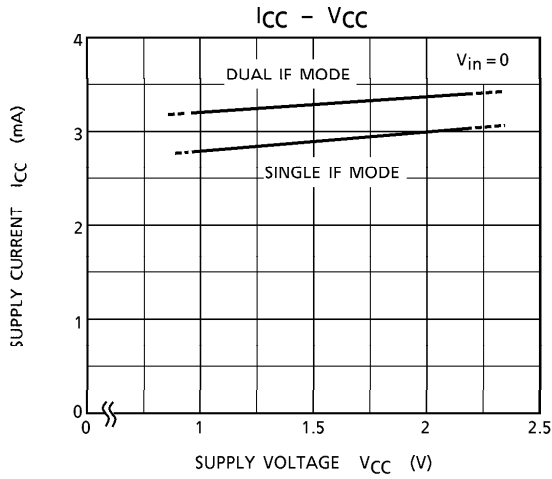

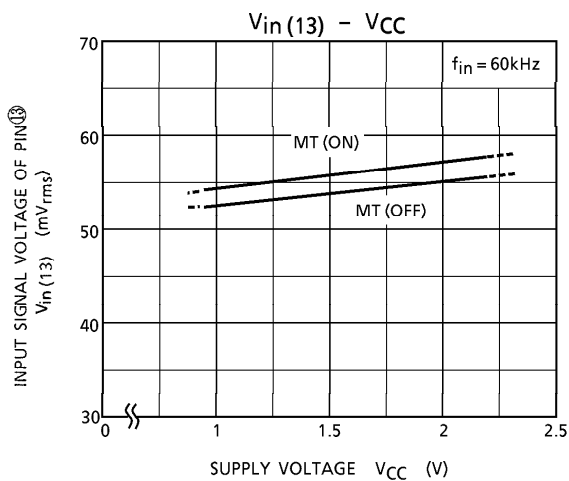
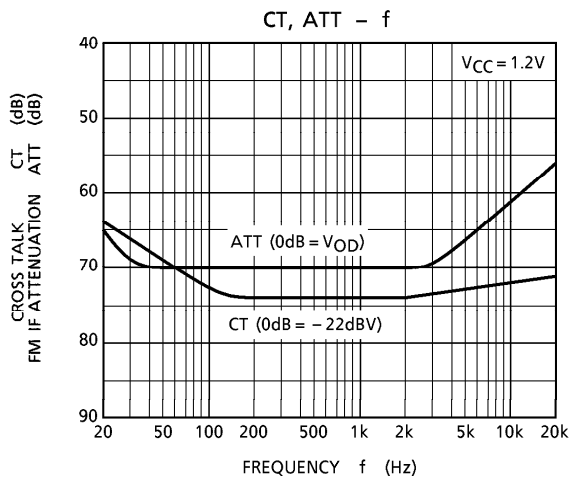
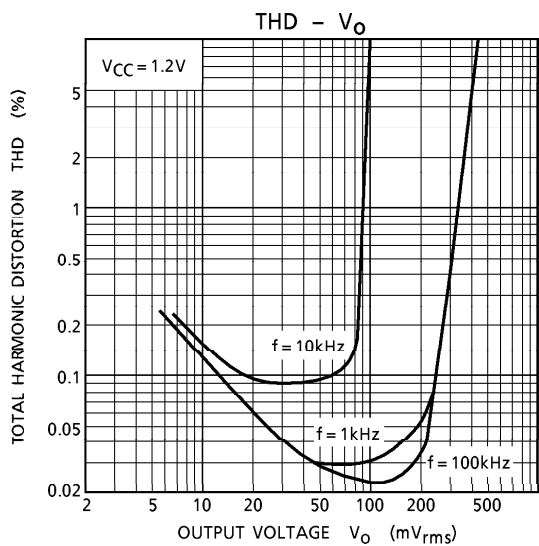
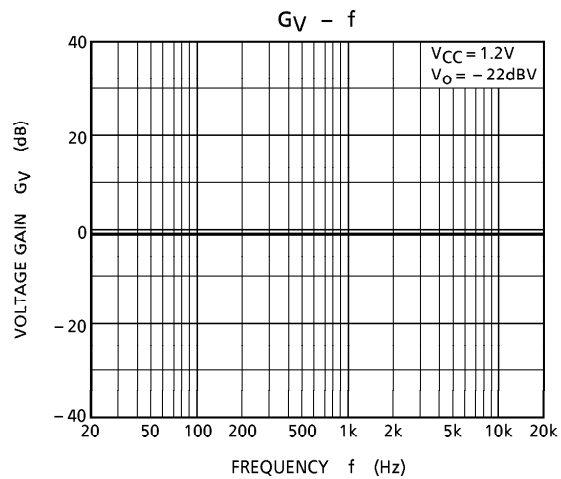
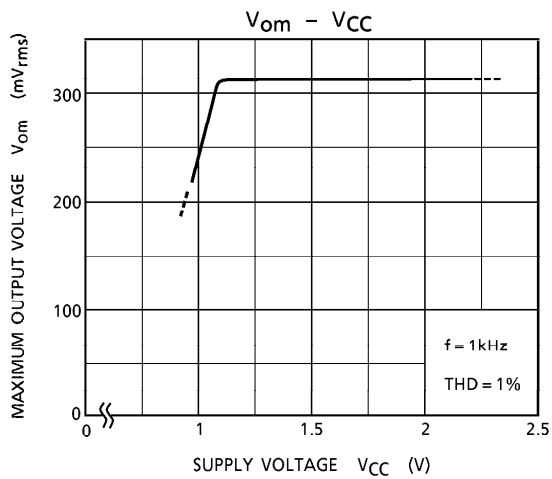

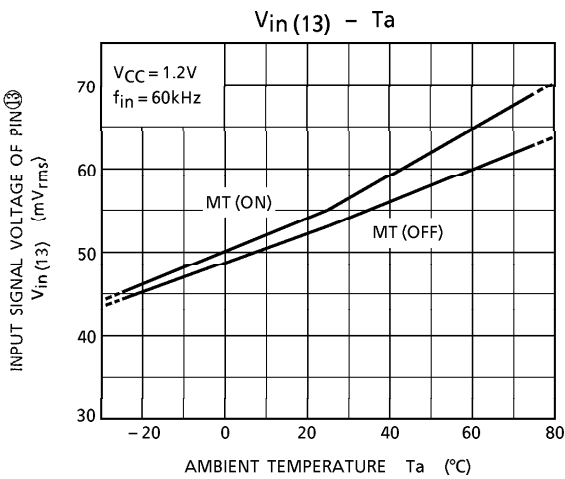
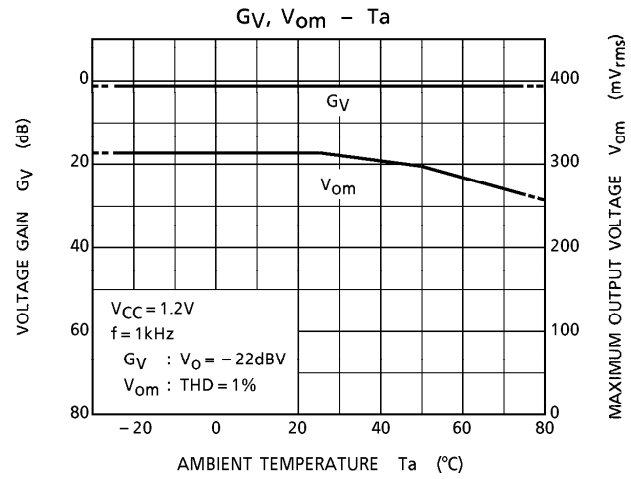
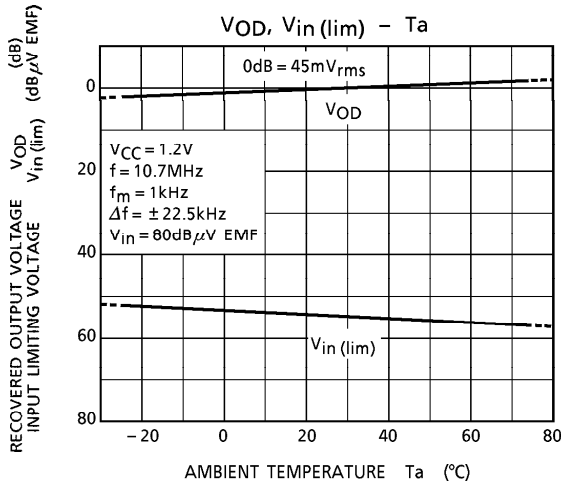
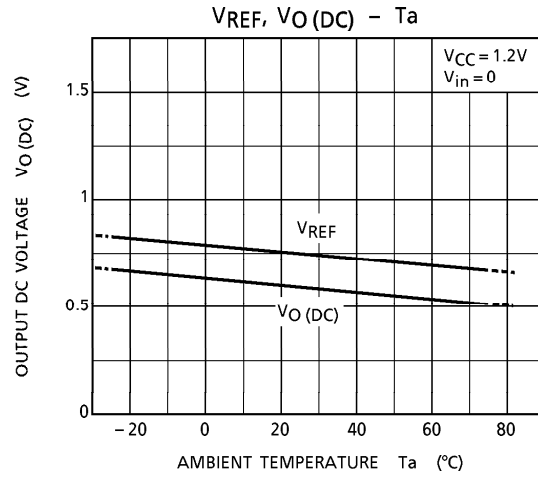
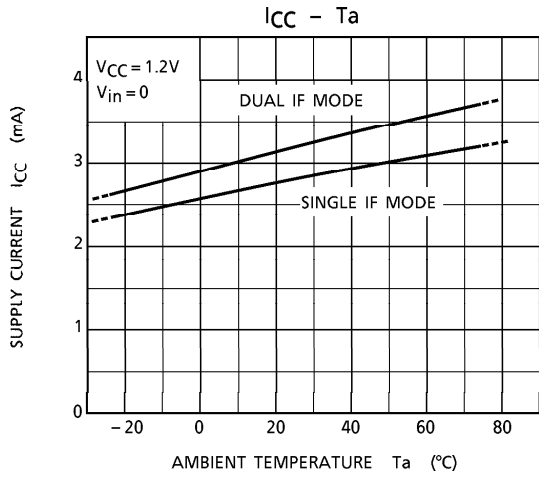

OUTLINE DRAWING

SSOP16-P-225-0.65B

Unit : mm

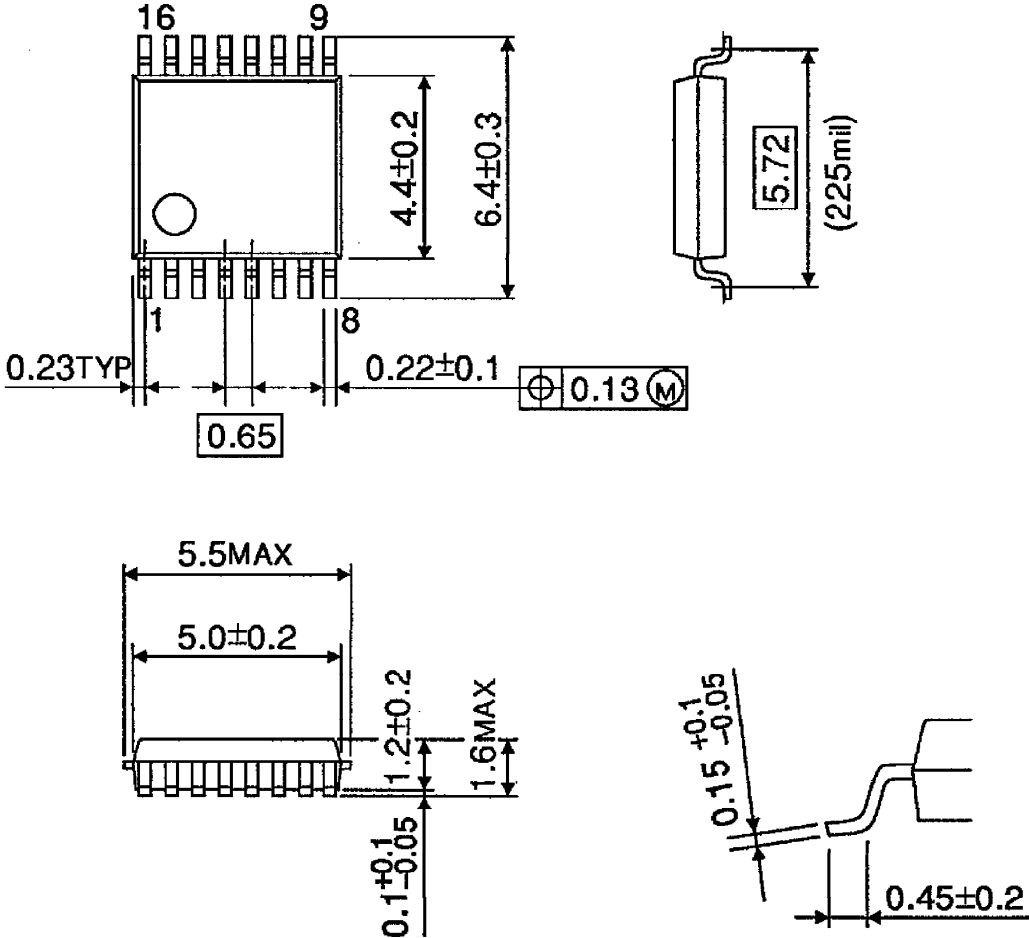

Weight : 0.09g (Typ.)