

## 3V AV / FM 1CHIP TUNER IC

TA8122AN/AF and TA8123AN/AF are the AM/FM 1Chip Tuner ICs, which are designed for Portable Radios and 3V Headphone Radios.

### FEATURES

- Built-in  
FM F/E, AM/FM IF and FM ST DET
- AM Detector Coil, FM IFT and IF Coupling Condenser are not needed.
- For adopting Ceramic Discriminator and Ceramic Resonator, it is not necessary to adjust the FM Quad Detector Circuit and FM ST DET VCO Circuit.
- S curve characteristics of FM detection output in TA8122AN/AF and TA8123AN/AF are reverse to each other.  
TA8122AN/AF : Reverse characteristic  
TA8123AN/AF : Normal characteristic
- Compact Package  
TA8122AN/23AN : Shrink DIP 24 pin (1.78mm pitch)  
TA8122AF/23AF : Mini Flat Package 24 pin
- Operating Supply Voltage Range  
 $V_{CC} = 1.8 \sim 7.0V$  ( $T_a = 25^\circ C$ )

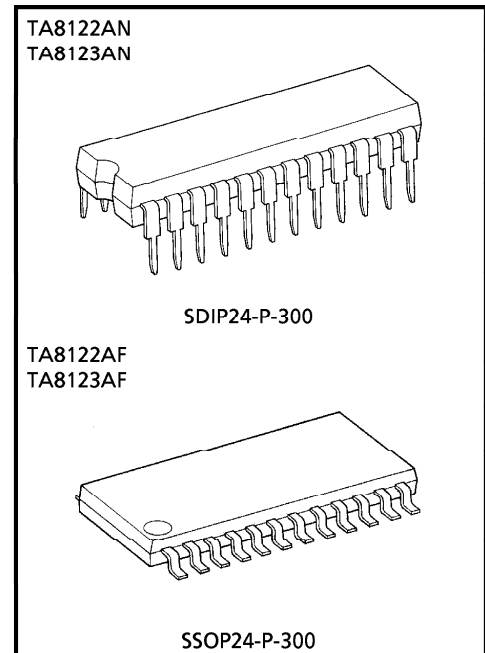

Weight SDIP24-P-300 : 1.2g (Typ.)  
SSOP24-P-300 : 0.31g (Typ.)

**BLOCK DIAGRAM**

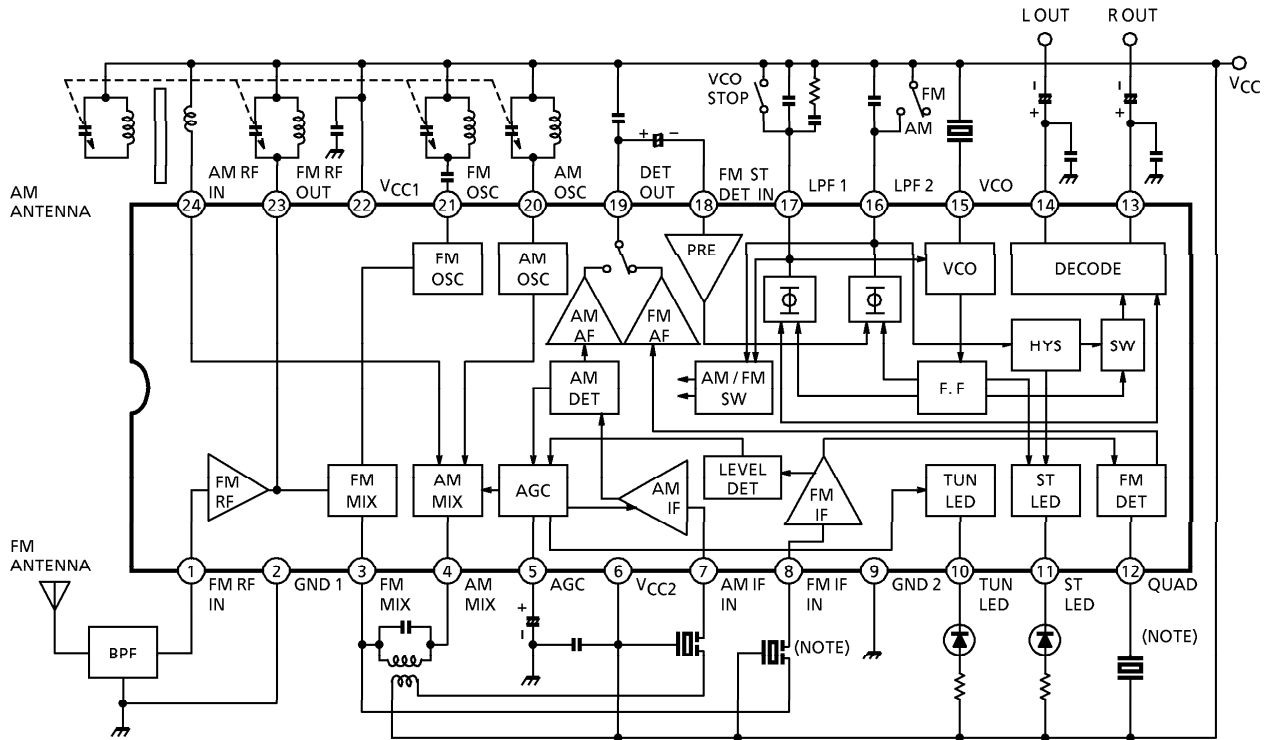

**(Note)**

We recommend the kit of the ceramic filter and the ceramic resonator which are shown in the table as below. It is necessary to meet the center frequency of the ceramic filter and the ceramic resonator, otherwise there are some cases that the characteristics get worse.

KIT NAME	COMBINATION			
	CERAMIC FILTER	Q'ty	CERAMIC RESONATOR	Q'ty
KMFC403-Z	SFE10.7MA5-Z	2	CDA10.7MG16-Z	1
KMFC411-Z	SFE10.7MA5-Z	1	CDA10.7MG16-Z	1
KMFC422-Z	SFE10.7MA2-Z	2	CDA10.7MG16-Z	1
KMFC435-Z	SFE10.7MA5L-Z	2	CDA10.7MG16-Z	1
KMFC445-Z	SFE10.7MA5L-Z	1	CDA10.7MG16-Z	1

MANUFACTURER : MURATA MFG. CO., LTD

**EXPLANATION OF TERMINALS**

PIN No.	CHARACTERISTIC	INTERNAL CIRCUIT	DC VOLTAGE (V) (AT NO SIGNAL)	
			AM	FM
1	FM-RF IN		0	0.7
2	GND1 (GND For RF Stage)	—	0	0
3	FM MIX		2.3	1.8
4	AM MIX		2.3	1.8
5	AGC (AM AGC)		0	0
6	VCC2 (VCC For IF/MPX Stage)	—	3.0	3.0

PIN No.	CHARACTERISTIC	INTERNAL CIRCUIT	DC VOLTAGE (V) (AT NO SIGNAL)	
			AM	FM
7	AM IF IN		3.0	3.0
8	FM IF IN		3.0	3.0
9	GND2 (GND For IF / MPX Stage)	—	0	0
10	TUN LED (Tuning LED)		—	—
11	ST LED (Stereo LED)		—	—
12	QUAD (FM QUAD. Detector)		2.4	2.1

PIN No.	CHARACTERISTIC	INTERNAL CIRCUIT	DC VOLTAGE (V) (AT NO SIGNAL)	
			AM	FM
13 14	R-OUT (R-ch Output) L-OUT (L-ch Output)		1.0	1.0
15	VCO		2.5	2.5 (VCO stop mode)
16	LPF2 <ul style="list-style-type: none"> <li>• LPF Terminal For Synchronous Detector</li> <li>• Bias Terminal For AM / FM SW Circuit</li> </ul> $V_{16} = V_{CC} \rightarrow \text{AM}$ $V_{16} = \text{Open} \rightarrow \text{FM}$		3.0	2.2 (VCO stop mode) 2.7
17	LPF1 LPF Terminal For Phase Detector VCO Stop Terminal $V_{17} = V_{CC} \rightarrow \text{VCO Stop}$		2.7	2.2
18	FM ST DET IN		0.7	0.7

PIN No.	CHARACTERISTIC	INTERNAL CIRCUIT	DC VOLTAGE (V) (AT NO SIGNAL)	
			AM	FM
19	DET OUT	<p>(a) LOW→FM, HIGH→AM (b) LOW→AM, HIGH→FM</p>	1.5	1.2
20	AM OSC		3.0	3.0
21	FM OSC		3.0	3.0
22	VCC1 (VCC For RF Stage)	—	3.0	3.0
23	FM RF OUT	cf. pin①	3.0	3.0
24	AM RF IN		3.0	3.0

**MAXIMUM RATINGS (Ta = 25°C)**

CHARACTERISTIC		SYMBOL	RATING	UNIT
Supply Voltage		V <sub>CC</sub>	8	V
LED Current		I <sub>LED</sub>	10	mA
LED Voltage		V <sub>LED</sub>	8	V
Power Dissipation	TA8122AN/23AN TA8122AF/23AF	P <sub>D</sub> (Note)	1200 400	mW
Operating Temperature			T <sub>opr</sub>	
Storage Temperature		T <sub>stg</sub>	- 55~150	°C

Note : Derated above 25°C in the proportion of 9.6mW/°C for TA8122AN/23AN and of 3.2mW/°C for TA8122AF/23AF

**ELECTRICAL CHARACTERISTICS**

Unless otherwise specified,

Ta = 25°C, V<sub>CC</sub> = 3V, F/E : f = 83MHz, f<sub>m</sub> = 1kHz  
 FM IF : f = 10.7MHz, Δf = ± 22.5kHz, f<sub>m</sub> = 1kHz  
 AM : f = 1MHz, MOD = 30%, f<sub>m</sub> = 1kHz  
 FM ST DET : f<sub>m</sub> = 1kHz

CHARACTERISTIC		SYMBOL	TEST CIR-CUIT	TEST CONDITION	MIN.	TYP.	MAX.	UNIT
Supply Current		I <sub>CC</sub> (FM)	1	V <sub>in</sub> = 0, FM mode	—	14.0	18.5	mA
		I <sub>CC</sub> (AM)	1	V <sub>in</sub> = 0, AM mode	—	6.0	8.3	
F/E	Input Limiting Voltage	V <sub>in</sub> (lim.)	1	- 3dB limiting	—	14.0	—	dB <sub>μ</sub> V EMF
	Local OSC Voltage	V <sub>OSC</sub>	2	f <sub>OSC</sub> = 72.3MHz	70	105	140	mV <sub>rms</sub>
	Input Limiting Voltage	V <sub>in</sub> (lim.) IF	1	- 3dB limiting	39	44	49	dB <sub>μ</sub> V EMF
FM IN	Recovered Output Voltage	V <sub>OD</sub>	1	V <sub>in</sub> = 80dB <sub>μ</sub> V EMF	55	80	110	mV <sub>rms</sub>
	Signal To Noise Ratio	S/N	1	V <sub>in</sub> = 80dB <sub>μ</sub> V EMF	—	70	—	dB
	Total Harmonic Distortion	THD	1	V <sub>in</sub> = 80dB <sub>μ</sub> V EMF	—	0.4	—	%
	AM Rejection Ratio	AMR	1	V <sub>in</sub> = 80dB <sub>μ</sub> V EMF	—	50	—	dB
	LED ON Sensitivity	V <sub>L</sub>	1	I <sub>L</sub> = 1mA	43	48	53	dB <sub>μ</sub> V EMF
AM	Gain	G <sub>V</sub>	1	V <sub>in</sub> = 23dB <sub>μ</sub> V EMF	20	40	80	mV <sub>rms</sub>
	Recovered Output Voltage	V <sub>OD</sub>	1	V <sub>in</sub> = 60dB <sub>μ</sub> V EMF	50	60	100	mV <sub>rms</sub>
	Signal To Noise Ratio	S/N	1	V <sub>in</sub> = 60dB <sub>μ</sub> V EMF	—	44	—	dB
	Total Harmonic Distortion	THD	1	V <sub>in</sub> = 60dB <sub>μ</sub> V EMF	—	1.0	—	%
	LED ON Sensitivity	V <sub>L</sub>	1	I <sub>L</sub> = 1mA	19	24	29	dB <sub>μ</sub> V EMF
Pin <sup>①</sup> Output Resistance		R <sub>19</sub>	1	FM mode	—	0.75	—	kΩ
				AM mode	—	12.5	—	



CHARACTERISTIC		SYMBOL	TEST CIRCUIT	TEST CONDITION	MIN.	TYP.	MAX.	UNIT		
FM ST DET	Input Resistance	$R_{IN}$	—	—	—	24	—	$k\Omega$		
	Output Resistance	$R_{OUT}$	—	—	—	5	—			
	Max. Composite Signal Input Voltage		$V_{in}$ (MAX.) STEREO	1	L + R = 90%, P = 10% $f_m = 1\text{kHz}$ , THD = 3%	—	350	—	$mV_{rms}$	
	Separation		Sep.	1	L + R =	$f_m = 100\text{Hz}$	—	42	$dB$	
					135 $mV_{rms}$	$f_m = 1\text{kHz}$	35	42		
					P = 15 $mV_{rms}$	$f_m = 10\text{kHz}$	—	42		
	Total Harmonic Distortion	Monaural	THD (MONAURAL)	1	$V_{in} = 150mV_{rms}$		—	0.2	$\%$	
		Stereo	THD (STEREO)		L + R = 135 $mV_{rms}$ , P = 15 $mV_{rms}$		—	0.2		
	Voltage Gain		$G_V$ (FM ST DET)	1	$V_{in} = 150mV_{rms}$		-5	-3	-1	$dB$
	Channel Balance		C.B.	1	$V_{in} = 150mV_{rms}$		-2	0	2	
	Stereo LED Sensitivity	ON	$V_L$ (ON)	1	Pilot Input		—	8	15	$mV_{rms}$
		OFF	$V_L$ (OFF)				2	6	—	
Stereo LED Hysteresis		$V_H$	1	To LED turn off from LED turn on		—	2	—	$mV_{rms}$	
Capture Range		C.R.	1	P = 15 $mV_{rms}$		—	1.3	—	$\%$	
Signal To Noise Ratio		S/N	1	$V_{in} = 150mV_{rms}$		—	70	—	$dB$	

**TEST CIRCUIT 1**

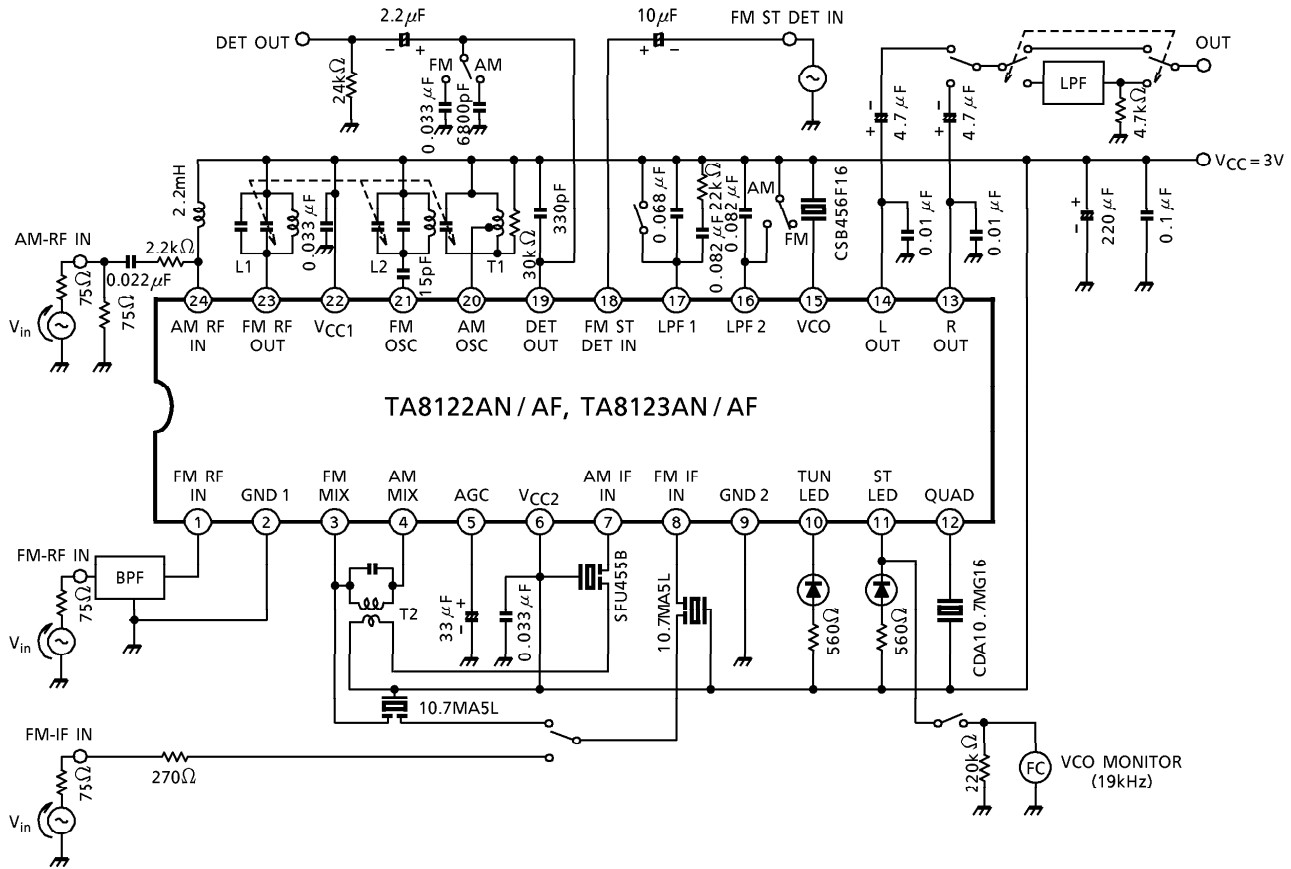

**TEST CIRCUIT 2**

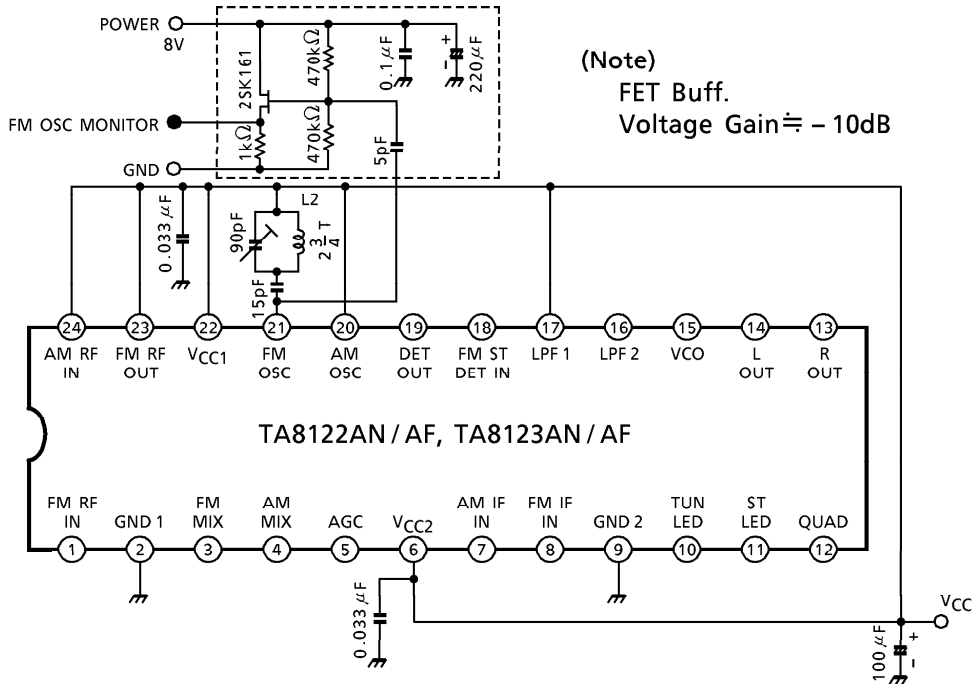

**COIL DATA**

COIL No.	TEST FREQ.	L (μH)	C <sub>0</sub> (pF)	Q <sub>0</sub>	TURNS					WIRE (mm φ)	REFERENCE
					1-2	2-3	1-3	1-4	4-6		
L <sub>1</sub> FM RF	100MHz	—	—	100	—	—	—	2 $\frac{1}{2}$	—	0.5UEW	Ⓢ 53T-037-202
L <sub>2</sub> FM OSC	100MHz	—	—	100	—	—	2 $\frac{3}{4}$	—	—	0.5UEW	Ⓢ 0258-244
T <sub>1</sub> AM OSC	796kHz	288	—	115	13	73	—	—	—	0.08UEW	Ⓢ 4147-1356-038
T <sub>2</sub> AM IFT	455kHz	—	180	120	—	—	180	—	15	0.08UEW	Ⓢ 2150-2162-165

Ⓢ : SUMIDA ELECTRIC CO., LED.

L<sub>1</sub> : FM RF

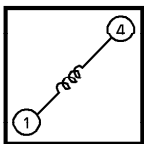

L<sub>2</sub> : FM OSC

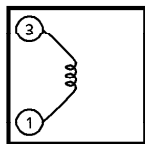

T<sub>1</sub> : AM OSC

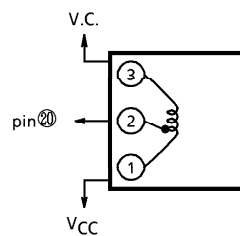

T<sub>2</sub> : AM IFT

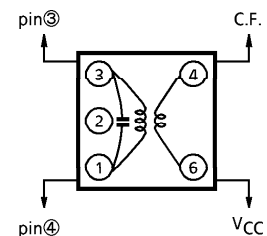

**FM DETECTION CIRCUIT**

For the FM detection circuit, detection coil is able to use instead of ceramic discriminator.  
Recommended circuit and recommended coil are as follows.  
In this case, please take care that  $V_{in}$  (lim.) falls a little.

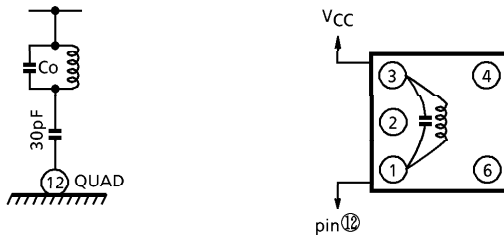

TEST FREQUENCY	$C_o$ (pF)	$Q_o$	TURNS				WIRE (mm $\phi$ )	REF
			1-2	2-3	1-3	4-6		
10.7MHz	100	100	—	—	12	—	0.12UEW	SUMIDA ELECTRIC CO., LTD 2153-4095-189 or Equivalent

FM (F/E + IF)  
VOD, V<sub>no</sub>, THD, AMR - V<sub>in</sub>

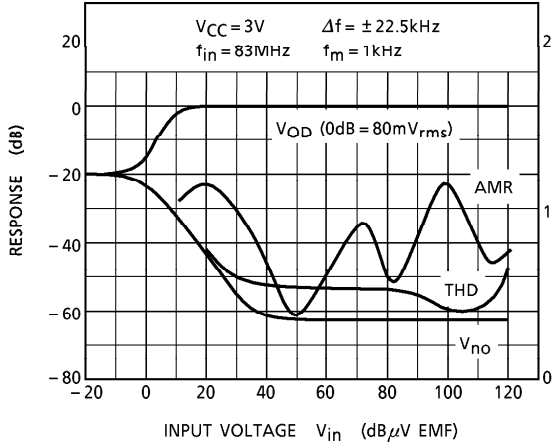

FM (IF)  
VOD, V<sub>no</sub>, THD - V<sub>in</sub>

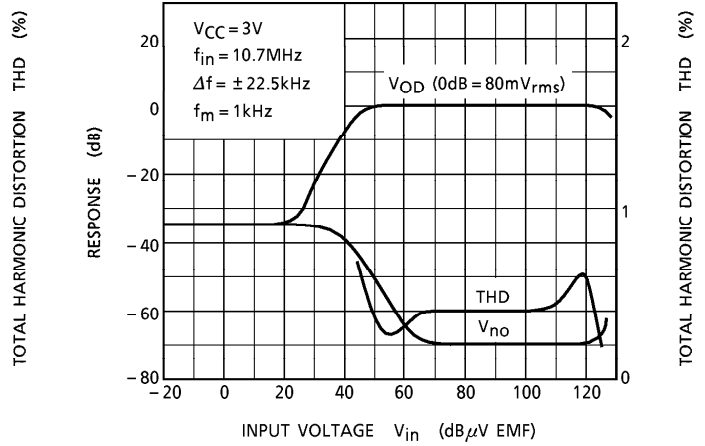

FM (IF)  
VOD, THD -  $\Delta f$

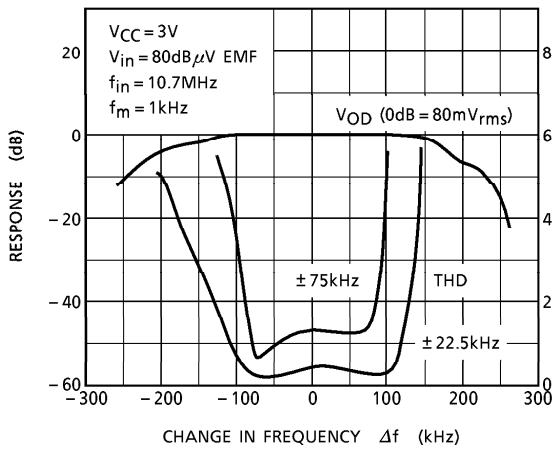

FM (IF)  
VOD, V<sub>in</sub> (lim.) - V<sub>CC</sub>

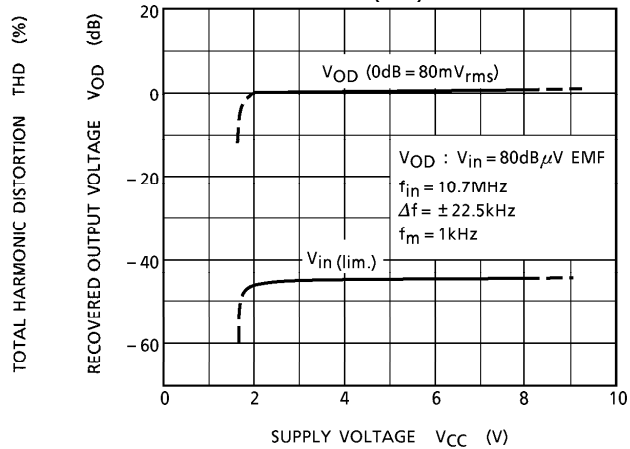

FM (IF)  
VOD - T<sub>a</sub>

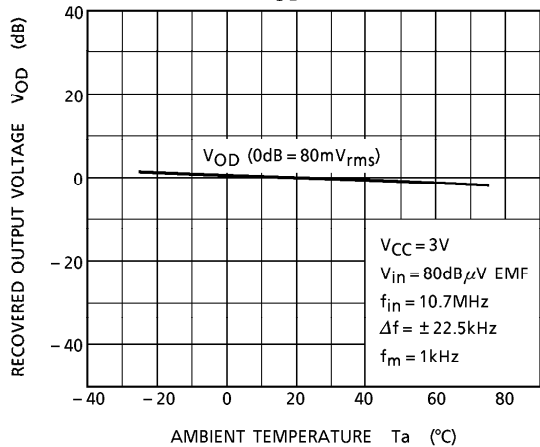

AM  
VOD, V<sub>no</sub>, THD - V<sub>in</sub>

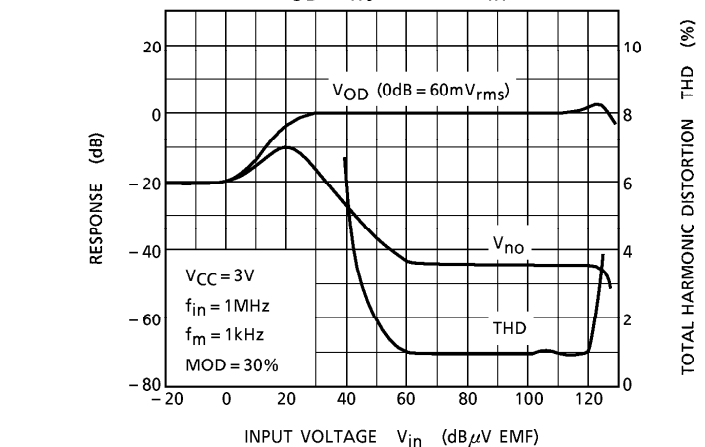

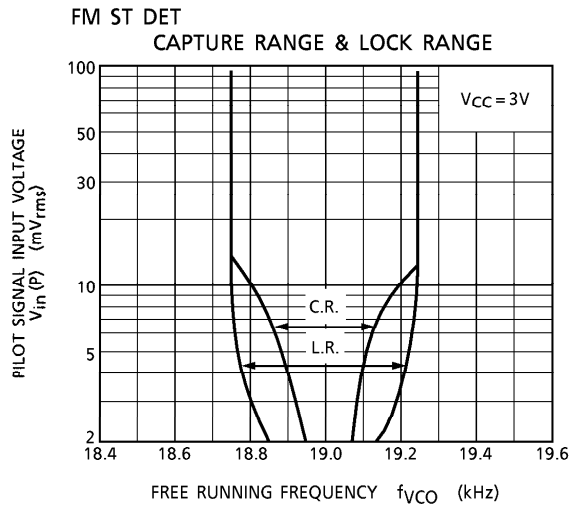
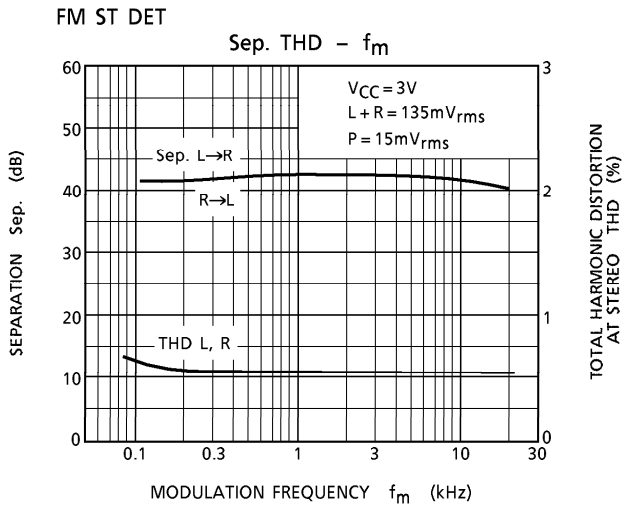
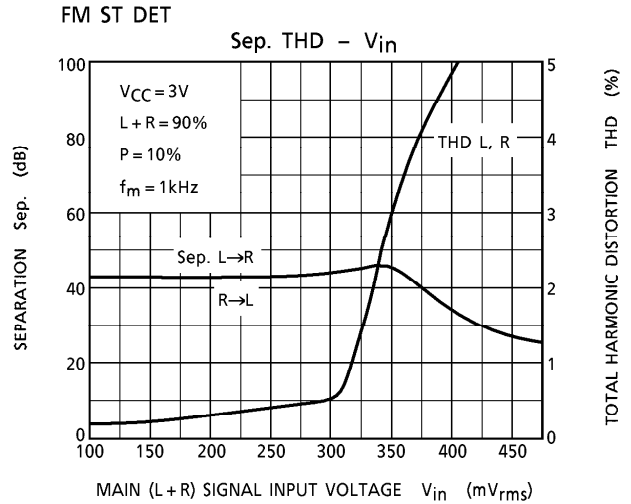
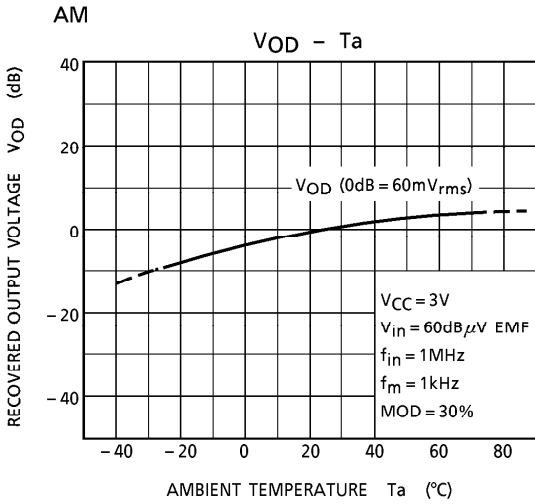
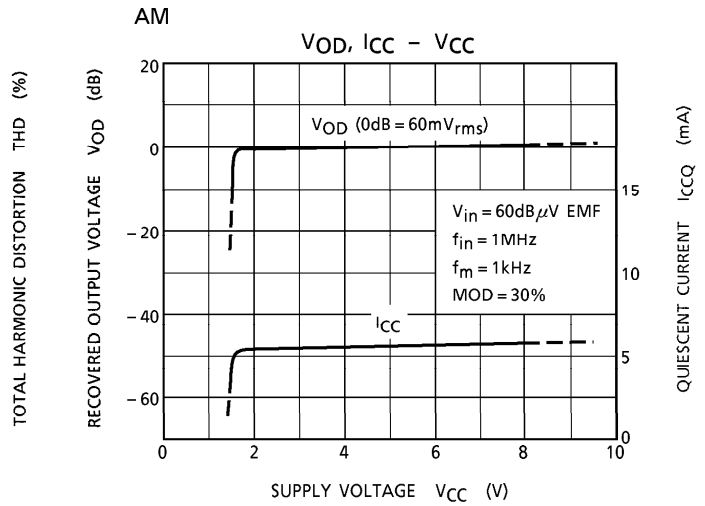
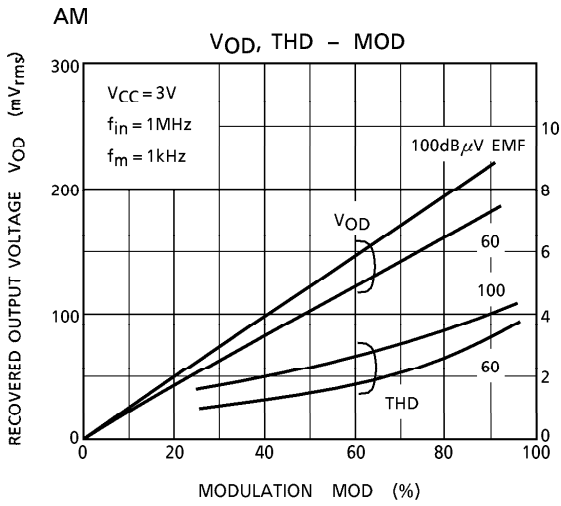

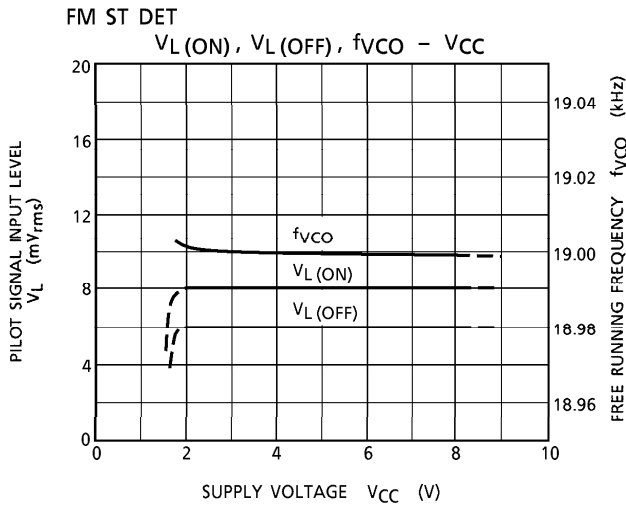
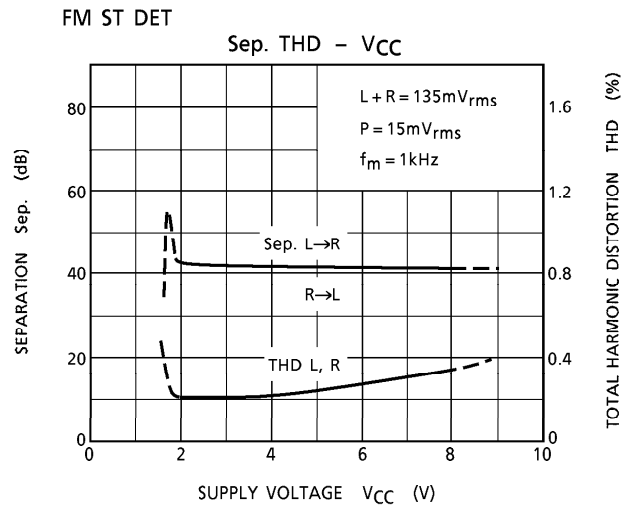
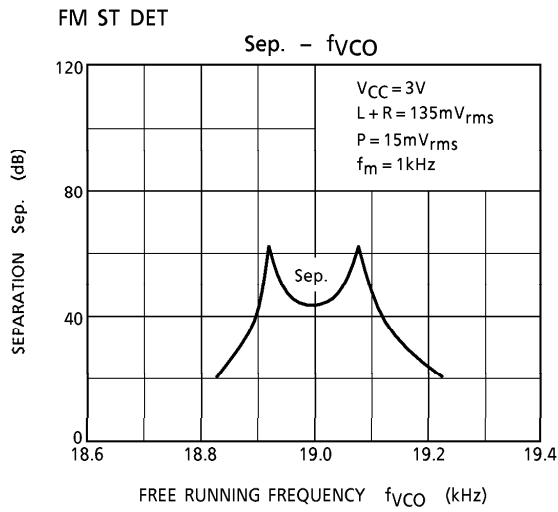

**OUTLINE DRAWING**  
SDIP24-P-300

Unit : mm

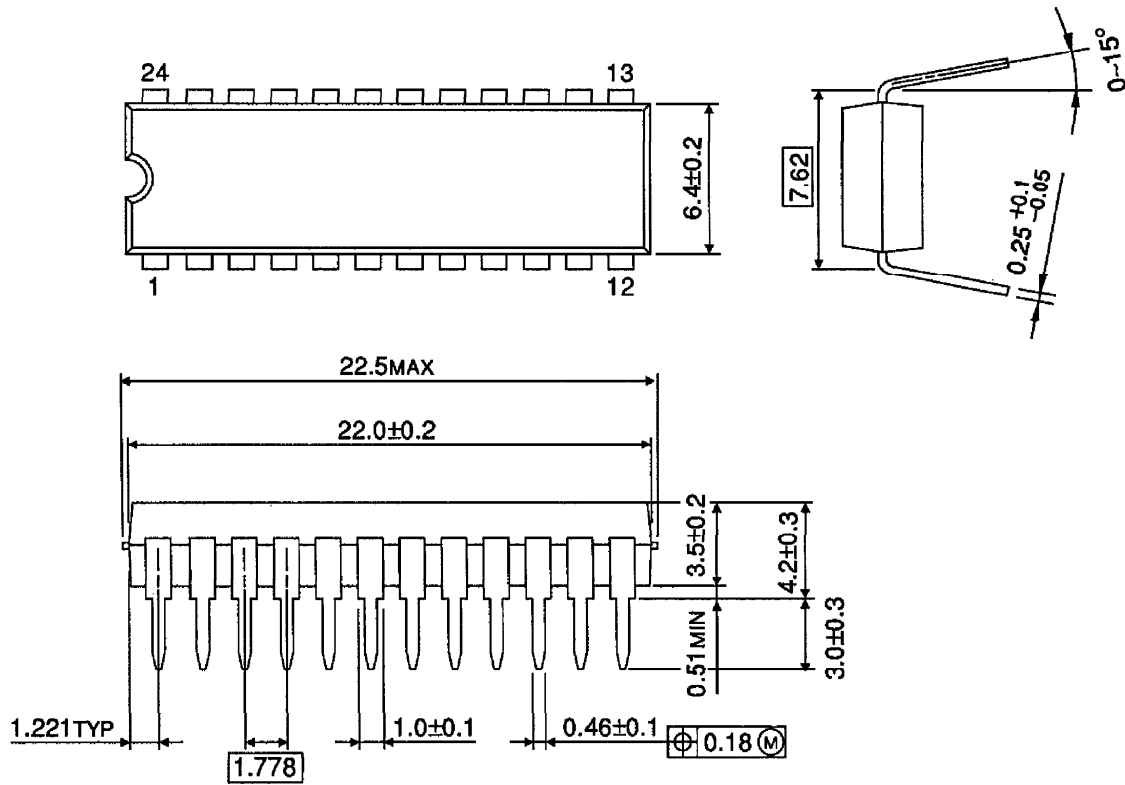

Weight : 1.2g (Typ.)



**OUTLINE DRAWING**  
SSOP24-P-300

Unit : mm

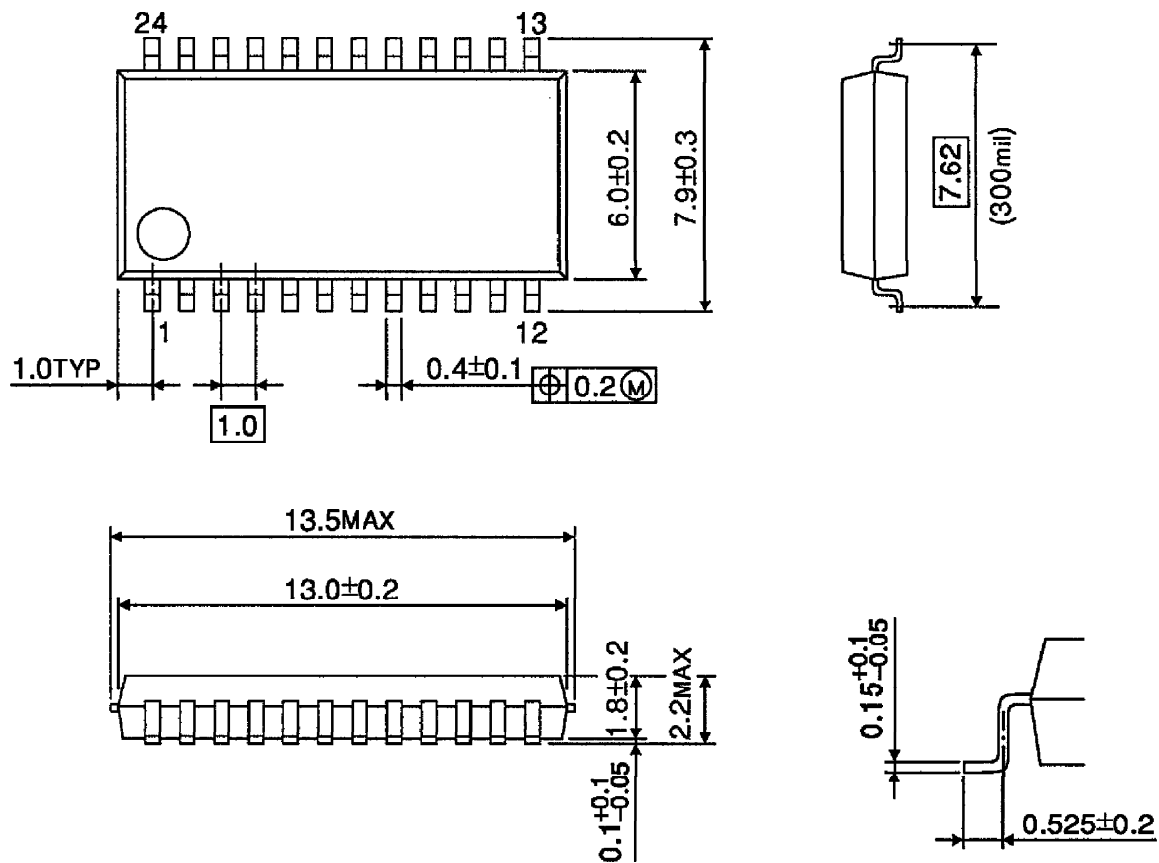

Weight : 0.31g (Typ.)