

TOSHIBA BIPOLAR LINEAR INTEGRATED CIRCUIT SILICON MONOLITHIC

# TA8004AS

## 5V LOW DROPOUT REGULATOR WITH RESET TIMER

The TA8004AS is a 5V regulator which handles 400mA Max. of output current. This IC generates a reset signal to reset the system when power is supplied or the 5V output voltage lowers to 85% or less of normal output voltage due to the external disturbances.

### FEATURES

- Maximum Output Current : 400mA (Max.)
- Low Input-Output Dropout Voltage : 0.6V (Max.)
- Multi Protection
  - Power supply reverse connection
  - Function for over voltage
  - Thermal protection
  - Short protection
- Internal Power ON Reset Timer
- TO-220 (IS) 5 Pin Package

### BLOCK DIAGRAM

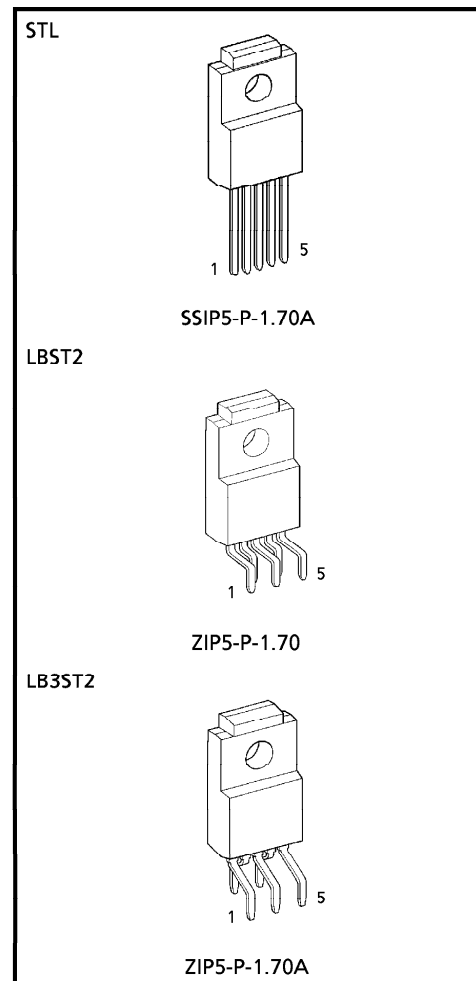
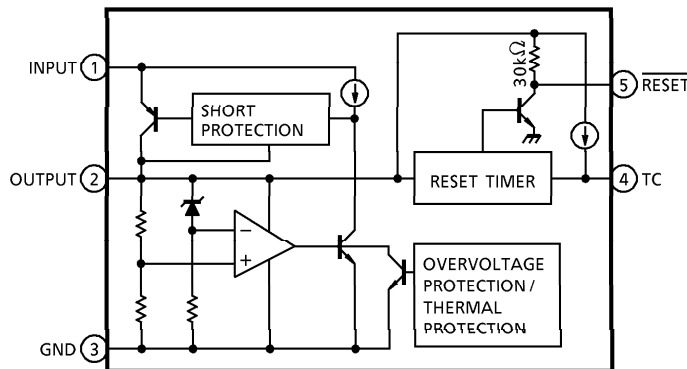

<b>Weight</b>	
SSIP5-P-1.70A	: 2.2g (Typ.)
ZIP5-P-1.70	: 2.2g (Typ.)
ZIP5-P-1.70A	: 2.2g (Typ.)

961001EBA2

● TOSHIBA is continually working to improve the quality and the reliability of its products. Nevertheless, semiconductor devices in general can malfunction or fail due to their inherent electrical sensitivity and vulnerability to physical stress. It is the responsibility of the buyer, when utilizing TOSHIBA products, to observe standards of safety, and to avoid situations in which a malfunction or failure of a TOSHIBA product could cause loss of human life, bodily injury or damage to property. In developing your designs, please ensure that TOSHIBA products are used within specified operating ranges as set forth in the most recent products specifications. Also, please keep in mind the precautions and conditions set forth in the TOSHIBA Semiconductor Reliability Handbook.

● The products described in this document are subject to foreign exchange and foreign trade control laws.

● The information contained herein is presented only as a guide for the applications of our products. No responsibility is assumed by TOSHIBA CORPORATION for any infringements of intellectual property or other rights of the third parties which may result from its use. No license is granted by implication or otherwise under any intellectual property or other rights of TOSHIBA CORPORATION or others.

● The information contained herein is subject to change without notice.

**PIN DESCRIPTIONS**

PIN No.	SYMBOL	DESCRIPTION
1	IN	Power supply terminal.
2	OUT	The 5V output terminal with maximum output current 400mA.
3	GND	Ground terminal.
4	TC	Terminal to set the reset timer. A capacitor is connected between this terminal and GND.
5	$\overline{\text{RESET}}$	Collector output of an NPN transistor with built-in pull-up resistor. This pin is put at LOW level at output voltage below 85% of a prescribed level and after output voltage becomes above 85% of a prescribed level, a reset signal for the time set at the TC terminal.

**TIMING CHART**

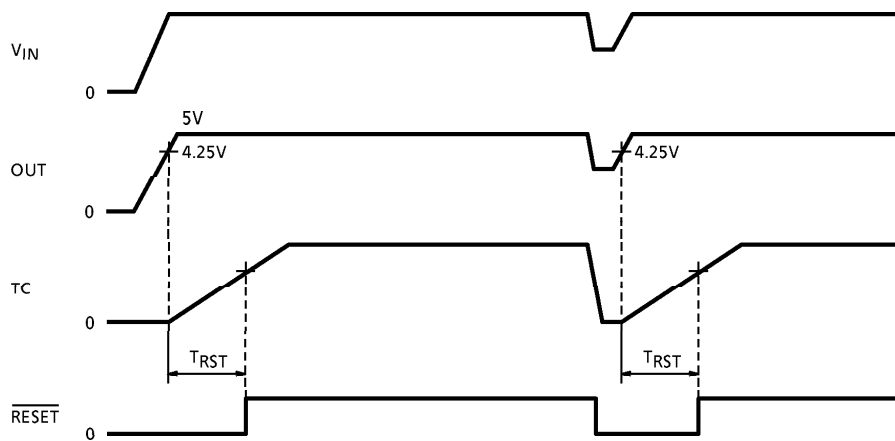

**MAXIMUM RATINGS (Ta = 25°C)**

CHARACTERISTIC	SYMBOL	RATING	UNIT
Input Voltage	$V_{IN}$	- 20~60	V
Power Dissipation	$P_D$	(Ta = 25°C)	2
		(Tc = 25°C)	20
Operating Temperature	$T_{opr}$	- 40~85	°C
Storage Temperature	$T_{stg}$	- 55~150	°C
Soldering Temperature·Time	$T_{sol}$	260 (10s)	°C
Thermal Resistance	$R_{th(j-c)}$	6.25	°C/W
	$R_{th(j-a)}$	62.5	

**ELECTRICAL CHARACTERISTICS** (Unless otherwise specified,  $V_{IN} = 14V$ ,  $I_{OUT} = 10mA$ ,  $T_j = 25^\circ C$ )

CHARACTERISTIC	SYMBOL	PIN	TEST CIR-CUIT	TEST CONDITION	MIN.	TYP.	MAX.	UNIT
Output Voltage	$V_{OUT}$	OUT	—	$5.35V \leq V_{IN} \leq 26V$ $I_{OUT} = 10mA$	4.8	5.0	5.2	V
				$5.35V \leq V_{IN} \leq 26V$ $I_{OUT} = 10mA$ $-40^\circ C \leq T_a \leq 85^\circ C$	4.5	5.0	5.5	
Line Regulation	Reg-Line	OUT	—	$10V \leq V_{IN} \leq 17V$ $I_{OUT} = 200mA$	—	4	50	mV
				$7V \leq V_{IN} \leq 26V$ $I_{OUT} = 200mA$	—	10	70	
Load Regulation	Reg-Load	OUT	—	$10mA \leq I_{OUT} \leq 200mA$	—	35	150	mV
Quiescent Current	$I_B$	GND	—	$6V \leq V_{IN} \leq 26V$ , $I_{OUT} = 0$	—	1.7	3	mA
				$V_{IN} = 14V$ , $I_{OUT} = 200mA$	—	10	—	
Dropout Voltage	$V_{DROP}$	IN / OUT	—	$I_{OUT} = 50mA$	—	0.08	0.2	V
				$I_{OUT} = 400mA$	—	0.3	0.6	
Max. Operating Input Voltage	$V_{IN}$	IN	—	—	29	32	—	V
Reset Voltage (H)	$V_{RST (H)}$	RST	—	—	4.5	5	5.5	V
Reset Voltage (L)	$V_{RST (L)}$	RST	—	$I_{SINK} = 2.5mA$	—	0.15	0.4	V
Delay Time	$T_{RST}$	RST	—	—	—	$0.3 \times C_{TC} (\mu F)$	—	s
TC Threshold	$V_{TH}$	TC	—	—	—	$V_{out} \times 60\%$	—	V
Delay Current	$I_{TC}$	TC	—	—	5	12	25	$\mu A$
$V_{OUT}$ Threshold	$V_{TH}$	OUT	—	—	—	$V_{out} \times 85\%$	—	V

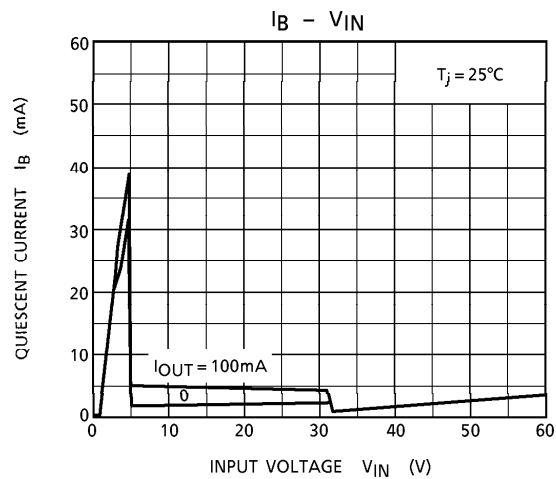
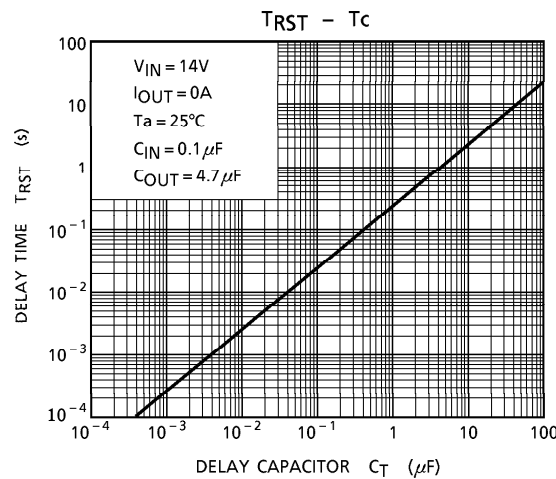
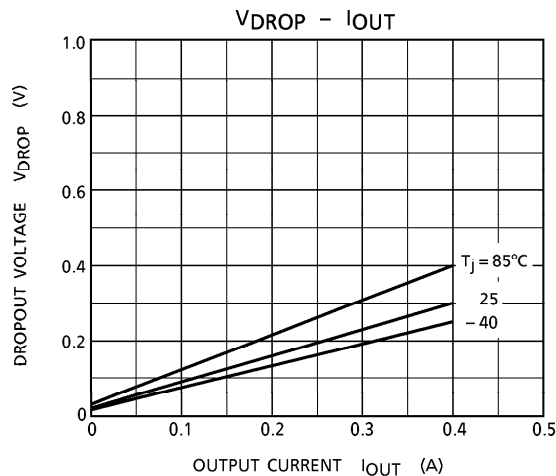
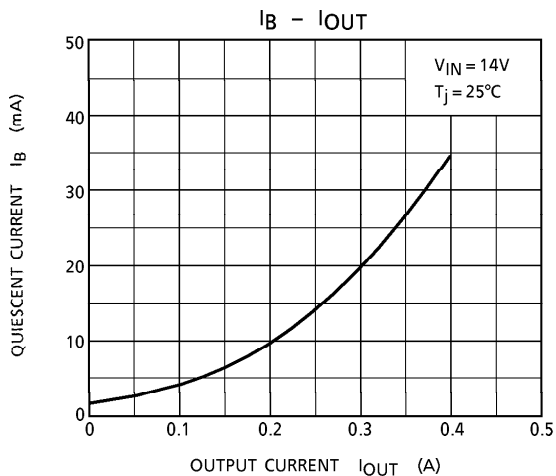
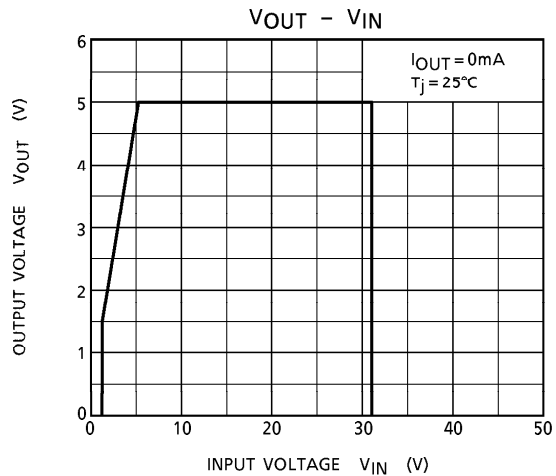
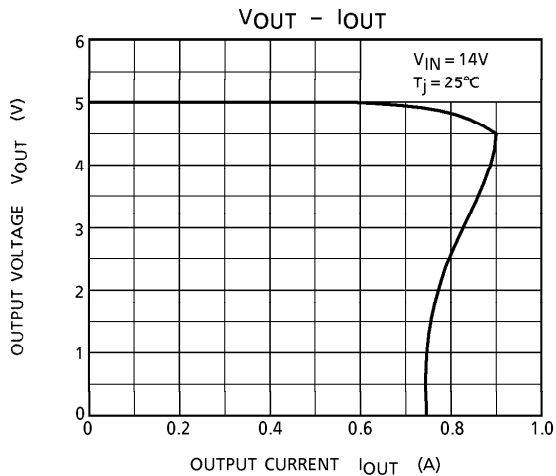

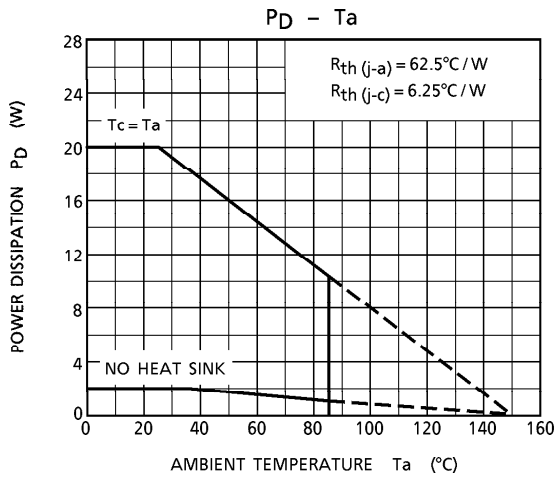

APPLICATION CIRCUIT

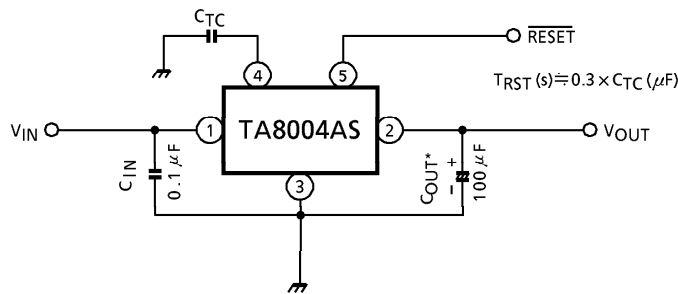

- \* Capacitor  $C_{OUT}$  must be guaranteed to operate of the temperature range that the regulator should be operated correctly.  
 $100 \mu F$  is a suitable value to suppress the oscillation phenomenon at the output terminal.

OUTLINE DRAWING  
SSIP5-P-1.70A (STL)

Unit : mm

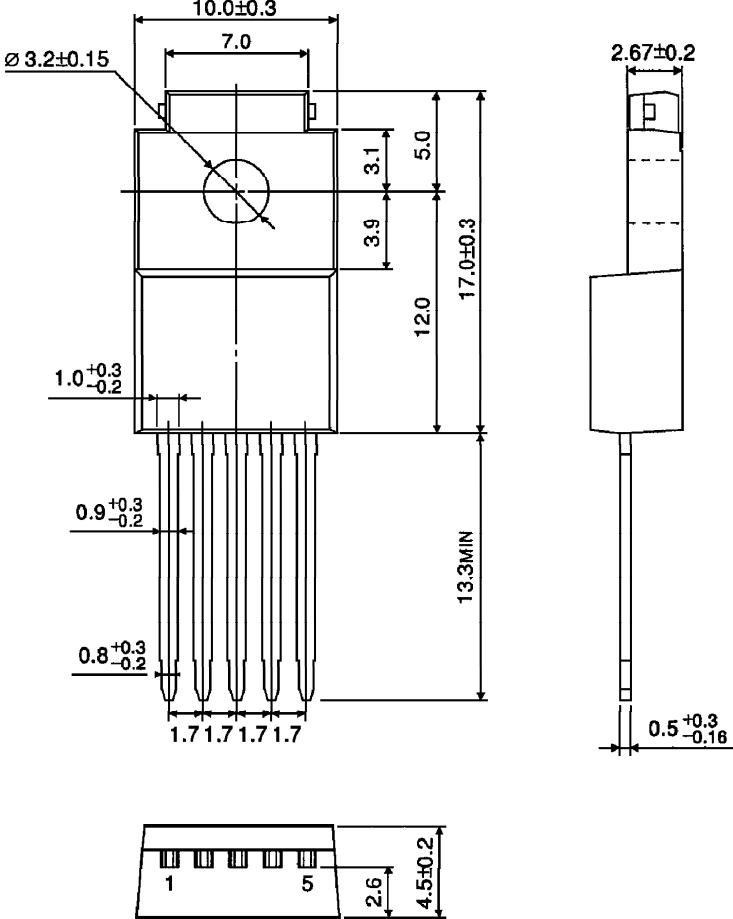

Weight : 2.2g (Typ.)

OUTLINE DRAWING  
ZIP5-P-1.70 (LBST2)

Unit : mm

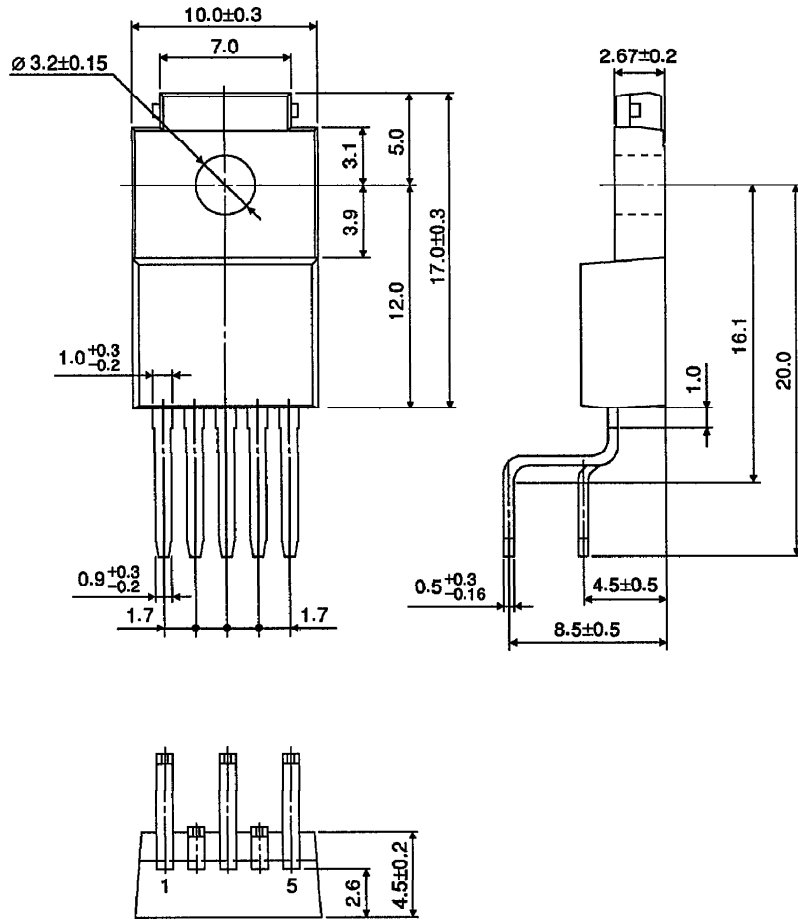

Weight : 2.2g (Typ.)

OUTLINE DRAWING  
ZIP5-P-1.70A (LB3ST2)

Unit : mm

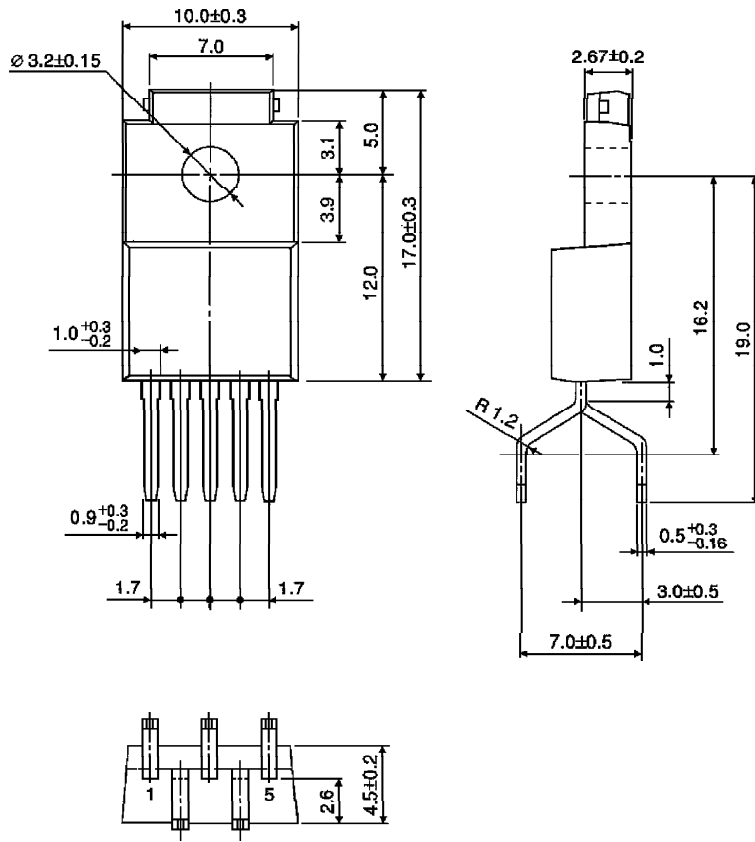

Weight : 2.2g (Typ.)