



Features

- High Efficiency Dual Output (See Ordering Information)
- Ideal Power Source for DSPs
- 5V/3.3V Input
- 6A Rated (Both Outputs)
- Internal Power-up Sequencing
- Single On/Off Control
- Independent Adjust/Trim
- Remote Sensing (V_{O1} & V_{O2})
- Soft-Start
- Short-Circuit Protection (coordinated shutdown)
- 27-pin Space-Saving Package
- Solderable Copper Case

Description

The PT6940 Excalibur™ power modules are a series of high-efficiency dual-output regulators, housed in a solderable space-saving package. The dual output is ideal for DSP applications that require a second voltage source for a processor core.

Both outputs from the PT6940 regulator modules are rated to deliver a full 6A load current simultaneously, and are internally sequenced to comply with the power-up requirements of popular DSP ICs.

Each output can be independently adjusted with a single external resistor, and incorporates an output sense to compensate for voltage drop between the regulator and load. A short-circuit load fault at either output will result in the coordinated shutdown of both voltages.

Ordering Information

PT6941□ = +3.3/2.5 Volts

PT6942□ = +3.3/1.8 Volts

PT6943□ = +3.3/1.5 Volts

PT6944□ = +3.3/1.2 Volts

† PT6946□ = +2.5/1.8 Volts

† PT6947□ = +2.5/1.5 Volts

† PT6948□ = +2.5/1.2 Volts

† -Denotes models that will also operate off 3.3V input bus.

PT Series Suffix (PT1234 x)

Case/Pin Configuration	Order Suffix	Package Code
Vertical	N	(ENE)
Horizontal	A	(ENF)
SMD	C	(ENG)

(Reference the applicable package code drawing for the dimensions and PC layout)

Pin-Out Information

Pin	Function	Pin	Function
1	STBY* †	15	V_{in}
2	V_{O1} Adjust	16	V_{in}
3	V_{O1} Sense	17	GND
4	V_{O1}	18	GND
5	V_{O1}	19	GND
6	V_{O1}	20	GND
7	GND	21	GND
8	GND	22	GND
9	GND	23	V_{O2}
10	GND	24	V_{O2}
11	GND	25	V_{O2}
12	GND	26	V_{O2} Sense
13	V_{in}	27	V_{O2} Adjust
14	V_{in}		

† STBY* pin: Open = Outputs enabled
Ground = Outputs disabled

Standard Application

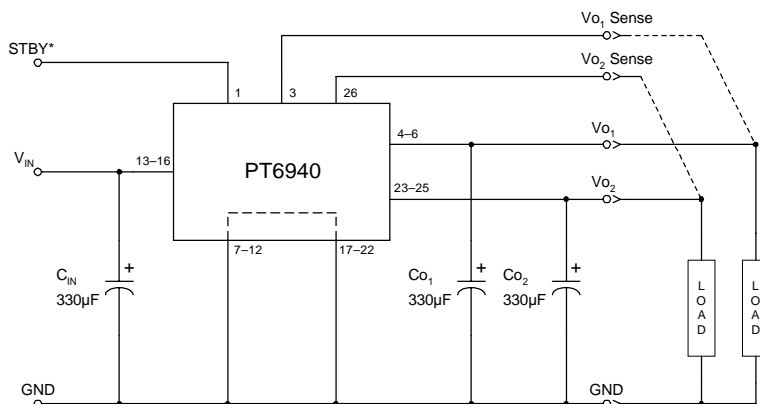

C_{in} = Req'd 330µF * electrolytic
 C_{O1}/C_{O2} = Req'd 330µF * electrolytic
 *300µF for Oscon® or low ESR tantalum (see application notes)

6-A Dual Output 5-V/3.3-V Input
Integrated Switching Regulator**General Specifications** (Unless otherwise stated, $T_a = 25^\circ\text{C}$, $V_{in} = 5\text{V}$, $C_{in} = 330\mu\text{F}$, $Co_1 = 330\mu\text{F}$, $Co_2 = 330\mu\text{F}$, and $I_{O1}/I_{O2} = I_{omax}$)

Characteristic	Symbol	Conditions	PT6940 Series			Units	
			Min	Typ	Max		
Output Current	I_o (1)	$T_a = 25^\circ\text{C}$, natural convection $T_a = 60^\circ\text{C}$, 200LFM airflow	0.1 (2) 0.1 (2)	— —	6 6	A	
Input Voltage Range	V_{in}	Over I_o Range	$V_{o1} \leq 2.5\text{V}$ 4.5	— —	5.5 5.5	V	
Set Point Voltage Tolerance	V_o tol		—	± 0.5	± 2	$\%V_o$	
Temperature Variation	Reg_{temp}	$-40^\circ \leq T_a \leq +85^\circ\text{C}$, $I_o = I_o$ min	—	± 0.5	—	$\%V_o$	
Line Regulation	Reg_{line}	Over V_{in} range	—	± 5	± 10	mV	
Load Regulation	Reg_{load}	Over I_o range	—	± 5	± 10	mV	
Total Output Voltage Variation	$\Delta V_{o,tot}$	Includes set-point, line, load, $-40^\circ \leq T_a \leq +85^\circ\text{C}$	$V_o = 3.3\text{V}$ — $V_o = 2.5\text{V}$ — $V_o = 1.8\text{V}$ — $V_o = 1.5\text{V}$ — $V_o = 1.2\text{V}$ —	± 43 — ± 35 — ± 28 — ± 25 — ± 22 —	± 100 — ± 75 — ± 54 — ± 45 — ± 36 —	mV	
Efficiency	η	$V_{in} = 5\text{V}$, $I_{O1} = I_{O2} = 4\text{A}$	PT6941 PT6942 PT6943 PT6944 PT6946 PT6947 PT6948	— — — — — — —	92 91 90 90 89 88 87	— — — — — — —	%
V_o Ripple (pk-pk)	V_r	20MHz bandwidth	—	35	—	mV _{pp}	
Transient Response	t_{tr}	1A/ μs load step, 50% to 100% I_o max	—	60	—	μs	
	ΔV_{tr}	V_o over/undershoot	—	± 70	—	mV	
Short Circuit Threshold	I_{sc} (pk)	Reset followed by auto-recovery	—	13 (3)	—	A	
Switching Frequency	f_o	Over V_{in} range	300	350	400	kHz	
STBY* (Pin 1)		Referenced to GND (pin 7)					
Input High Voltage	V_{IH}		—	—	Open (4)	V	
Input Low Voltage	V_{IL}		-0.1	—	+0.4		
Input Low Current	I_{IL}		—	-0.5	—	mA	
Quiescent Current	$I_{in,standby}$	pin 1 to GND	—	10	20	mA	
External Output Capacitance		Both outputs	330	—	TBD	μF	
Operating Temperature Range	T_a	Over V_{in} Range	-40 (5)	—	+85 (6)	$^\circ\text{C}$	
Storage Temperature	T_s	—	-40	—	+125	$^\circ\text{C}$	
Mechanical Shock		Per Mil-STD-883D, Method 2002.3 1 msec, 1/2 Sine, mounted	—	TBD	—	G's	
Mechanical Vibration		Mil-STD-883D Method 2007.2, 20-2000 Hz	Vertical — Horizontal —	TBD (7) — TBD (7) —	— — — —	G's	
Weight	—	Vertical/Horizontal	—	34	—	grams	
Flammability	—	Meets UL 94V-O	—	—	—	—	

- Notes:**
- (1) The outputs, V_{o1} and V_{o2} , have similar characteristics. The applicable performance parameters are defined according to output voltage.
 - (2) The minimum output current applies to each output. The module will operate at no load with reduced specifications.
 - (3) A short-circuit load fault at either output causes the module to continuously reset, affecting both outputs.
 - (4) The STBY* control (pin 1) has an internal pull-up, and if it is left open circuit the module will operate when input power is applied. The open-circuit voltage is approximately the input voltage, V_{in} . Refer to the application notes for interface considerations.
 - (5) For operating temperatures below 0°C , C_{in} , Co_1 , and Co_2 must have stable characteristics. Use either tantalum or Oscon® capacitors.
 - (6) See Safe Operating Area curves for the specific output voltage combination, or contact the factory for the appropriate derating.
 - (7) Only the case pins on through-hole pin configurations (N & A) must be soldered. For more information see the applicable package outline drawing.

Input/Output Capacitors: The PT6940 series requires a 330 μF electrolytic capacitor at the input and both outputs for proper operation (300 μF for Oscon® or low ESR tantalum). In addition, the input capacitance must be rated for a minimum of 1.0Arms ripple current. For transient or dynamic load applications, additional capacitance may be required. Refer to the application notes for more information.

6-A Dual Output 5-V/3.3-V Input Integrated Switching Regulator

Performance Characteristics; $V_{in} = 5V$ (See Note A)

Performance Characteristics; $V_{in} = 3.3V$ (See Note A)

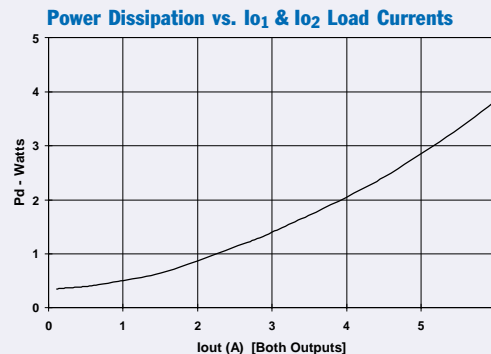
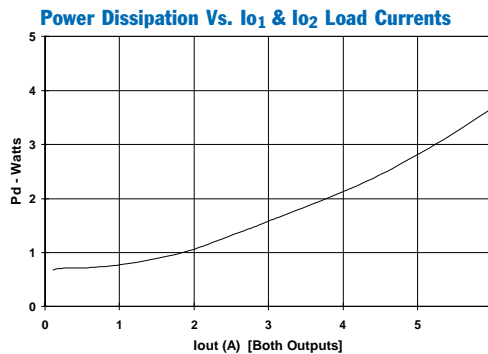
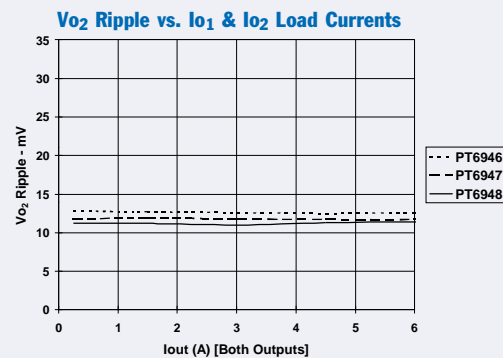
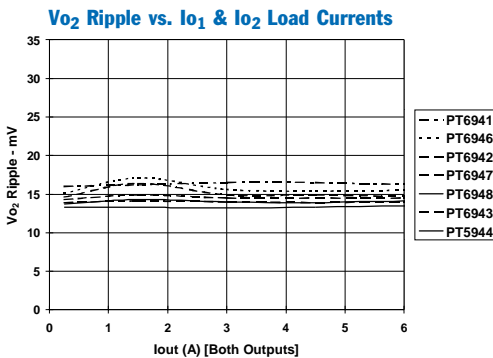
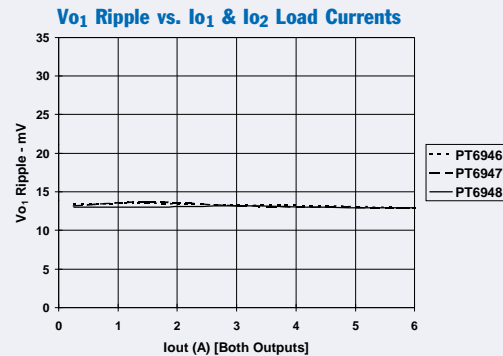
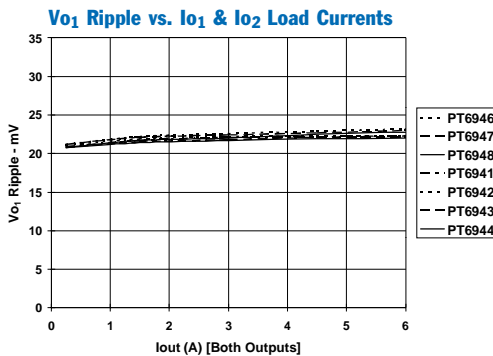
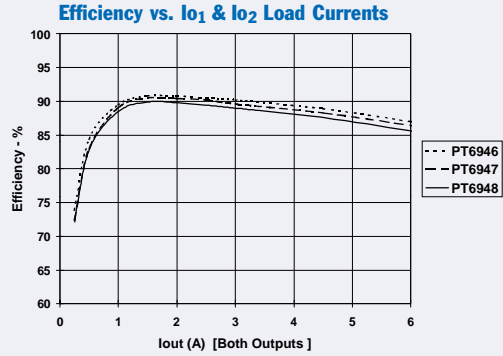
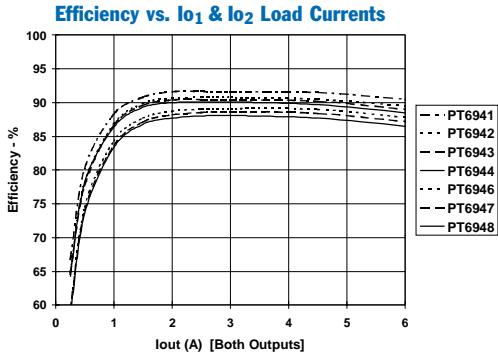

Note A: Characteristic data has been developed from actual products tested at 25°C. This data is considered typical data for the Converter.

6-A Dual Output 5-V/3.3-V Input Integrated Switching Regulator

Safe Operating Area Curves; $V_{in} = 5V$ (See Note B)

Safe Operating Area Curves; $V_{in} = 3.3V/5V$ (See Note B)

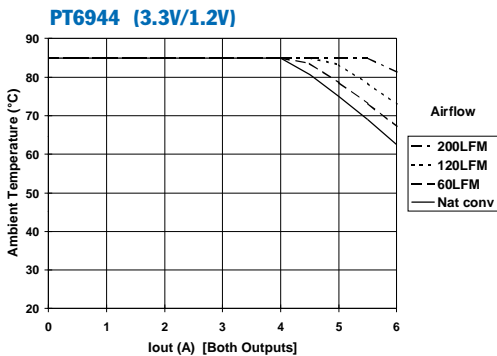
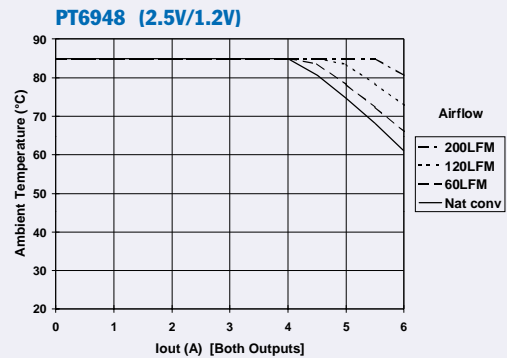
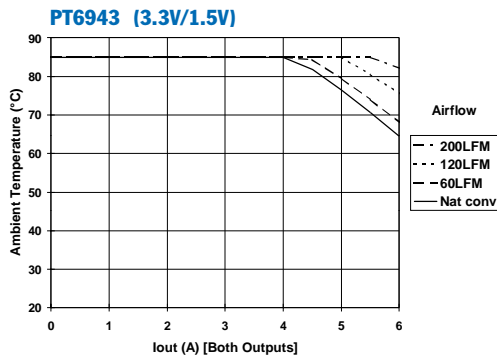
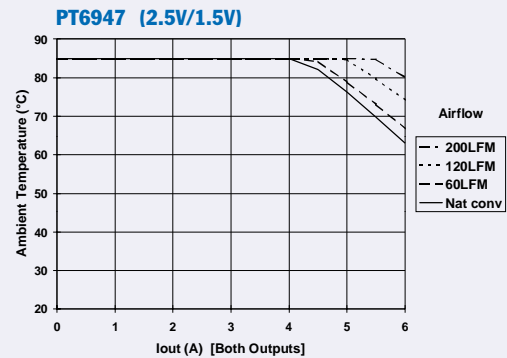
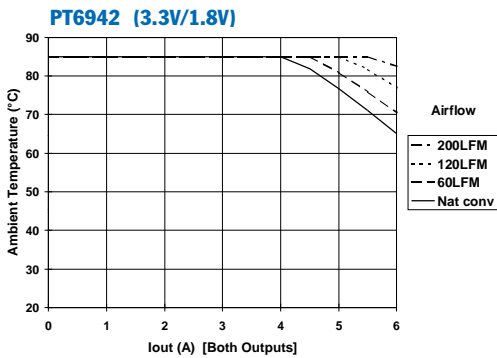
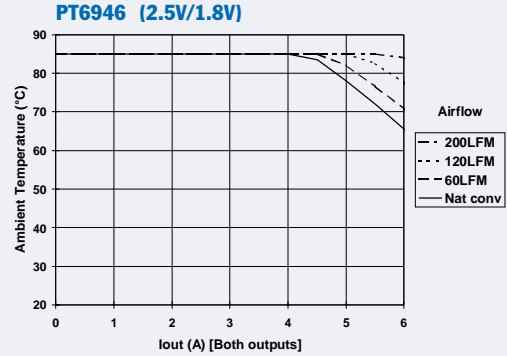
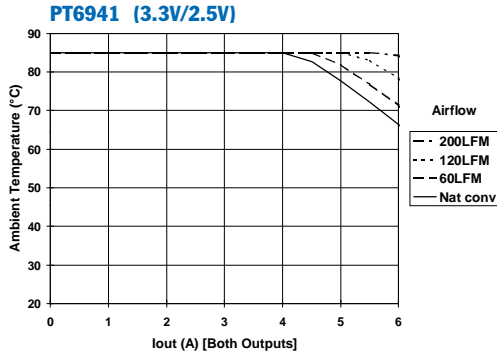

Note B: SOA curves represent the conditions at which internal components are at or below the manufacturer's maximum operating temperatures

Operating Features of the PT6940 Series of Dual-Output Voltage Regulators

Over-Current Protection

The PT6940 series of regulators incorporate independent current limit protection at both outputs (V_{O1} & V_{O2}) with a periodic shutdown of both outputs. Applying a load current, in excess of the current limit threshold to either output, results in the shutdown of both voltages after a short period; typically 15ms. Following shutdown the module periodically attempts to recover by executing a soft start power-up at intervals of approximately 100ms. If the over-current persists, each attempted restart will result in a corresponding over-current trip and shutdown. During the 15ms period prior to each successive shutdown, the output with the load fault may not reach full regulation.

Power-Up Voltage Sequencing

The output voltages from the PT6940 series regulators are independently regulated, and internally sequenced to meet the power-up requirements of popular microprocessors and DSP chipsets. Figure 1 shows the output voltage waveforms of a PT6942 (3.3V/1.8V) after either input power is applied, or the regulator is enabled. In this example turning Q_1 off in Figure 2, removes the low-voltage signal at pin 1 and enables the regulator. Following a delay of about 3–5ms, V_{O1} and V_{O2} rise together until the lower voltage, V_{O2} , reaches its regulation voltage. V_{O1} then continues to rise until both outputs reach full regulation. The total power-up time is less than 15ms, and is relatively independent of load, temperature, and output capacitance. The turn-off of Q_1 corresponds to the rise in V_{STBY} . The waveforms were measured with a 5V input voltage, and with resistive loads of 4A at both the V_{O1} and V_{O2} outputs.

Figure 1

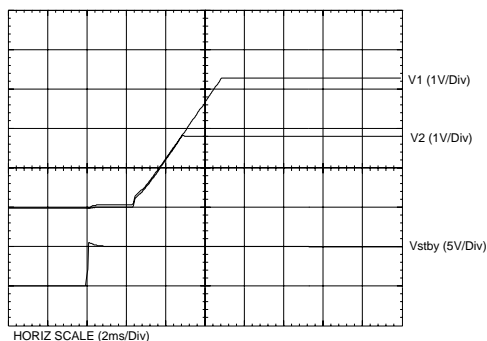

Standby Control

The output voltages from the PT6940 may be disabled using the regulator's *Standby* control. The standby function is provided by the "STBY*" control (pin 1). If pin 1 is left open-circuit the regulator operates normally, and provides a regulated output at both V_{O1} (pins 4–6) and V_{O2} (pins 23–25) whenever a valid input source voltage is applied to V_{in} (pins 13–16) with respect to GND (pins 7–12 & 17–22). Applying a low-impedance sink to ground¹ at pin 1, simultaneously disables both regulated outputs. This places the regulator in standby mode, and reduces the input current drawn by the ISR to typically 10mA. The *Standby* control may also be used to maintain both regulator outputs at zero volts during the period that input power is applied.

The standby pin is ideally controlled using an open-collector (or open-drain) discrete transistor (See Figure 2). The open-circuit voltage is the input voltage, V_{in} .

Figure 2

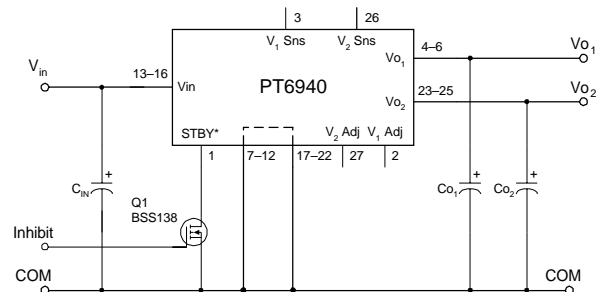

Notes:

1. The standby control input is *Not* compatible with TTL or other devices that incorporate a totem-pole output drive. Use only a true open-collector device, preferably a discrete bipolar transistor (or MOSFET). To ensure the regulator output is disabled, the control pin must be pulled to less than 0.4Vdc with a low-level 0.5mA sink to ground.
2. **Do not** use an external pull-up resistor. The control pin has its own internal pull-up. Adding an external pull-up could disable the over-current protection. The open-circuit voltage of the "STBY*" pin is the input voltage, V_{in} .

Capacitor Recommendations for the Dual-Output PT6940 Regulator Series

Input Capacitor:

The recommended input capacitance is determined by 1.0 ampere minimum ripple current rating and 330 μ F minimum capacitance (300 μ F for Oscon® or low ESR tantalum). Ripple current and <100m Ω equivalent series resistance (ESR) values are the major considerations, along with temperature, when designing with different types of capacitors. Tantalum capacitors have a recommended minimum voltage rating of twice the maximum DC voltage + AC ripple. This is necessary to insure reliability for input voltage bus applications

Output Capacitors: Co₁/Co₂

The ESR of the required capacitors, Co₁ & Co₂ must not be greater than 150m Ω . Electrolytic capacitors have poor ripple performance at frequencies greater than 400kHz but excellent low frequency transient response. Above the ripple frequency, ceramic capacitors are necessary to improve the transient response and reduce any high frequency noise components apparent during higher current excursions. Preferred low ESR type capacitor part numbers are identified in Table 1.

Tantalum Capacitors

Tantalum type capacitors can be used for the output but only the AVX TPS series, Sprague 593D/594/595 series or Kemet T495/T510 series. These capacitors are recommended over many other tantalum types due to their higher rated surge, power dissipation, and ripple current capability. As a caution the TAJ series by AVX is not recommended. This series has considerably higher ESR, reduced power dissipation, and lower ripple current capability. The TAJ series is less reliable than the AVX TPS series when determining power dissipation capability. Tantalum or Oscon® types are recommended for applications where ambient temperatures fall below 0°C.

Capacitor Table

Table 1 identifies the characteristics of capacitors from a number of vendors with acceptable ESR and ripple current (rms) ratings. The number of capacitors required at both the input and output buses is identified for each capacitor type.

This is not an extensive capacitor list. Capacitors from other vendors are available with comparable specifications. Those listed are for guidance. The RMS ripple current rating and ESR (Equivalent Series Resistance at 100kHz) are critical parameters necessary to insure both optimum regulator performance and long capacitor life.

Table 1: Input/Output Capacitors

Capacitor Vendor/ Component Series	Capacitor Characteristics					Quantity		Vendor Number
	Working Voltage	Value(μ F)	(ESR) Equivalent Series Resistance	85°C Maximum Ripple Current(Irms)	Physical Size(mm)	Input Bus	Output Bus	
Panasonic FC	25V	560 μ F	0.0065 Ω	1205mA	12.5x15	1	1	EEUFC1E561S
	35V	390 μ F	0.065 Ω	1205mA	12.5x15	2	1	EEUFC1V391S
	35V	330 μ F	0.117 Ω	555mA	8x11.5	N/R	1	EEUFC1C331
United Chemi-Con LXV/FS/LXZ	16V	330 μ F	0.120 Ω	555mA	8x12	N/R	1	LXZ16VB331M8X12LL
	35V	470 μ F	0.052 Ω	1220mA	10x20	1	1	LXZ35VB471M10X20LL
	10V	330 μ F	0.025 Ω	3500mA	10x10.5	1	1	10FS330M
	20V	150 μ F	0.030+2 Ω	3200mA	10x10.5	2	2	20FS150M
Nichicon PL/ PM	35V	560 μ F	0.048 Ω	1360mA	16x15	1	1	UPL1V561MHH6
	35V	330 μ F	0.065+2 Ω	1020mA	12.5x15	1	1	UPL1V331MHH6
	50V	470 μ F	0.046 Ω	1470mA	18x15	1	1	UPM1H4711MHH6
Panasonic FC (Surface Mtg)	10V	1000 μ F	0.043 Ω	1205mA	12x16.5	1	1	EEVFC1A102LQ
	35V	330 μ F	0.065 Ω	1205mA	12.5x16	1	1	EEVFC1V331LQ
	16V	330 μ F	0.150 Ω	670mA	10x10.2	N/R	1	EEVFC1C331P
Oscon- SS SV	10V	330 μ F	0.025 Ω	>3500mA	10.0x10.5	1	1	10SS330M
	10V	330 μ F	0.025 Ω	>3800mA	10.3x10.3	1	1	10SV300M
	20V	150 μ F	0.024+2 Ω	3600mA	10.3x10.3	2	2	20SV150M SV= Surface Mount
AVX Tantalum TPS	10V	330 μ F	0.100+2 Ω	>2500mA	7.3Lx	2	1	TPSV337M010R0100
	10V	330 μ F	0.100+2 Ω	>3000mA	4.3Wx	2	1	TPSV337M010R0060
	10V	220 μ F	0.095 Ω	>2000mA	4.1H	2	2	TPSV227M0105R0100
Kemet T510/T495	10V	330 μ F	0.033 Ω	1400mA	7.3Lx5.7W x 4.0H	2	1	T510X337M010AS
	10V	220 μ F	0.07 Ω +2 =0.035 Ω	>2000mA		2	2	T495X227M010AS
Sprague 594D	10V	330 μ F	0.045 Ω	2350mA	7.3Lx 6.0Wx	2	1	4D337X0010R2T
	10V	220 μ F	0.065 Ω	>2000mA	4.1H	2	2	594D227X0010D2T

N/R –Not recommended. The voltage rating does not meet the minimum operating limits.

Adjusting the Output Voltages of the PT6940 Dual-Output ISRs

Each output voltage from the PT6940 series of integrated switching regulators (ISRs) can be independently adjusted higher or lower than the factory trimmed pre-set voltage. The voltages, V_{O1} and V_{O2} may each be adjusted either up or down using a single external resistor ¹. Table 1 gives the adjustment range for both V_{O1} and V_{O2} for each model in the series as $V_a(\text{min})$ and $V_a(\text{max})$. Note that V_{O2} must always be lower than V_{O1} ².

V_{O1} Adjust Up: To increase the output, add a resistor R_2 between pin 2 (V_{O1} Adjust) and pins 7-12 (GND) ³.

V_{O1} Adjust Down: Add a resistor (R_1), between pin 2 (V_{O1} Adjust) and pin 3 (V_{O1} Sense).

V_{O2} Adjust Up: Add a resistor R_4 between pin 27 (V_{O2} Adjust) and pins 17-22 (GND).

V_{O2} Adjust Down: Add a resistor (R_3) between pin 27 (V_{O2} Adjust) and pin 26 (V_{O2} Sense).

Refer to Figure 1 and Table 2 for both the placement and value of the required resistor.

The adjust up and adjust down resistor values can also be calculated using the following formulas. Be sure to select the correct formula parameter from Table 1 for the output and model being adjusted.

$$(R_1) \text{ or } (R_3) = \frac{10(V_a - 0.9)}{V_o - V_a} - R_s \quad \text{k}\Omega$$

$$R_2 \text{ or } R_4 = \frac{9}{V_a - V_o} - R_s \quad \text{k}\Omega$$

Where: V_o = Original output voltage, (V_{O1} or V_{O2})

V_a = Adjusted output voltage

R_s = The series resistance from Table 1

Notes:

1. Use only a single 1% resistor in either the (R_1) or R_2 location to adjust V_{O1} , and in the (R_3) or R_4 location to adjust V_{O2} . Place the resistor as close to the module as possible.
2. V_{O2} must always be at least 0.3V lower than V_{O1} .
3. When adjusting V_{O1} higher than the factory pre-set output voltage the minimum input voltage must be revised as follows.

$V_{O1} = 3.3V$:

$V_{in}(\text{min}) = (V_{O1} + 1)V$ or 4.5V, whichever is greater.

$V_{O1} = 2.5V$:

$V_{O1} = 2.5V$ is the maximum output voltage allowed for operation off a 3.3V input bus. If V_{O1} is adjusted above 2.5V, the input voltage must be a minimum of 4.5V.

4. V_{O1} and V_{O2} may be adjusted down to an alternative bus voltage by making, (R_1) or (R_3) respectively, a zero ohm link. Refer to the Table 1 footnotes for guidance.
5. Never connect capacitors to either the V_{O1} Adjust or V_{O2} Adjust pins. Any capacitance added to these control pins will affect the stability of the respective regulated output.

Figure 1

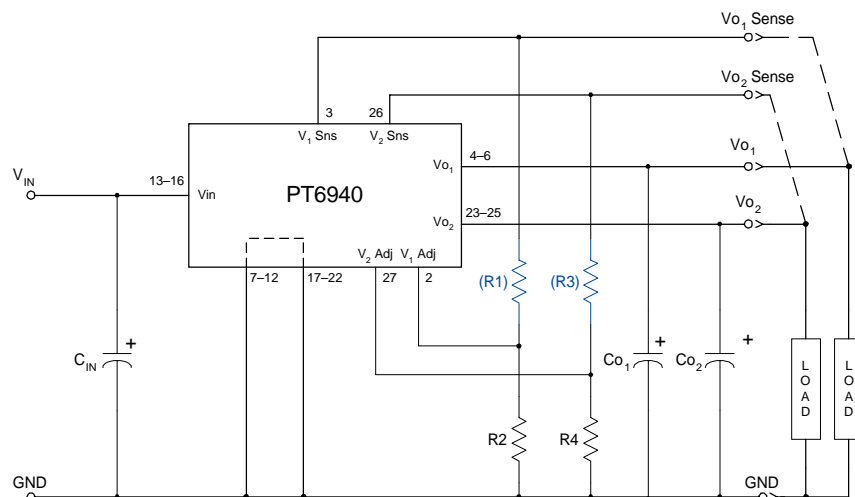

PT6940 Series

Table 1

ADJUSTMENT RANGE AND FORMULA PARAMETERS

Vo ₁ Bus			Vo ₂ Bus ⁽²⁾			
Series Pt #	PT6941/42/43/44	PT6946/47/48	PT6941	PT6942/46	PT6943/47	PT6944/48
Adj. Resistor	(R1)/R2	(R1)/R2	(R3)/R4	(R3)/R4	(R3)/R4	(R3)/R4
V _o (nom)	3.3V	2.5V	2.5V	1.8V	1.5V	1.2V
V _a (min)	2.5V*	1.8V*	1.8V*	1.5V*	1.2V*	1.15V
V _a (max)	3.5V	2.5V	3.1V	2.2V	2.4V	1.5V †
R _s (kΩ)	20.0	13.0	13.0	20.0	10.0	29.4

Ref. Note 4: * (R1) = Zero-ohm link
 † (R3) = Zero-ohm link

Table 2

ADJUSTMENT RESISTOR VALUES

Vo ₁ Bus			Vo ₂ Bus				
Series Pt #	PT6941/42/43/44	PT6946/47/48	Series Pt #	PT6941	PT6942/46	PT6943/47	PT6944/48
Adj. Resistor	(R1)/R2	(R1)/R2	Adj. Resistor	(R3)/R4	(R3)/R4	(R3)/R4	(R3)/R4
V _o (nom)	3.3V	2.5V	V _o (nom)	2.5V	1.8V	1.5V	1.2V
V _a (req'd)			V _a (req'd)				
1.8		(0.0)	1.15				(20.6)kΩ
1.85		(1.6)kΩ	1.2			(0.0)kΩ	
1.9		(3.7)kΩ	1.25			(4.0)kΩ	151.0kΩ
1.95		(6.1)kΩ	1.3			(10.0)kΩ	60.6kΩ
2.0		(9.0)kΩ	1.35			(20.0)kΩ	30.6kΩ
2.05		(12.6)kΩ	1.4			(40.0)kΩ	15.6kΩ
2.1		(17.0)kΩ	1.45			(100.0)kΩ	6.6kΩ
2.15		(22.7)kΩ	1.5		(0.0)kΩ		0.0kΩ
2.2		(30.3)kΩ	1.55		(6.0)kΩ	170.0kΩ	
2.25		(41.0)kΩ	1.6		(15.0)kΩ	80.0kΩ	
2.3		(57.0)kΩ	1.65		(30.0)kΩ	50.0kΩ	
2.35		(83.7)kΩ	1.7		(60.0)kΩ	35.0kΩ	
2.4		(137.0)kΩ	1.75		(150.0)kΩ	26.0kΩ	
2.45		(297.0)kΩ	1.8	(0.0)kΩ		19.6kΩ	
2.5	(0.0)kΩ		1.85	(1.6)kΩ	160.0kΩ	15.7kΩ	
2.55	(2.0)kΩ	167.0kΩ #	1.9	(3.7)kΩ	70.0kΩ	12.5kΩ	
2.6	(4.3)kΩ	77.0kΩ #	1.95	(6.1)kΩ	40.0kΩ	10.0kΩ	
2.65	(6.9)kΩ	47.0kΩ #	2.0	(9.0)kΩ	25.0kΩ	8.0kΩ	
2.7	(10.0)kΩ	32.0kΩ #	2.05	(12.6)kΩ	16.0kΩ	6.4kΩ	
2.75	(13.6)kΩ	23.0kΩ #	2.1	(17.0)kΩ	10.0kΩ	5.0kΩ	
2.8	(18.0)kΩ		2.15	(22.7)kΩ	5.7kΩ	3.9kΩ	
2.85	(23.3)kΩ		2.2	(30.3)kΩ	2.5kΩ	2.9kΩ	
2.9	(30.0)kΩ		2.25	(41.0)kΩ		2.0kΩ	
2.95	(38.6)kΩ		2.3	(57.0)kΩ		1.3kΩ	
3.0	(50.0)kΩ		2.35	(83.7)kΩ		0.6kΩ	
3.1	(90.0)kΩ		2.4	(137.0)kΩ		0.0kΩ	
3.2	(210.0)kΩ		2.45	(297.0)kΩ			
3.3			2.5				
3.4	70.0kΩ		2.55	167.0kΩ			
3.5	25.0kΩ		2.6	77.0kΩ			
3.6	10.0kΩ		2.65	47.0kΩ			
3.7	2.5kΩ		2.7	32.0kΩ			
			2.75	23.0kΩ			
			2.8	17.0kΩ			
			2.85	12.7kΩ			
			2.9	9.5kΩ			
			2.95	7.0kΩ			
			3.0	5.0kΩ			
			3.1	2.0kΩ			

R₁/R₃ = (Blue), R₂/R₄ = Black
 # See Note 3

PACKAGING INFORMATION

Orderable Device	Status (1)	Package Type	Package Drawing	Pins	Package Qty	Eco Plan (2)	Lead/Ball Finish	MSL Peak Temp (3)	Samples (Requires Login)
PT6941A	OBSOLETE	SIP MODULE	ENF	27		TBD	Call TI	Call TI	
PT6941C	LIFEBUY	SIP MODULE	ENG	27	10	Pb-Free (RoHS)	Call TI	Level-3-215C-168HRS	
PT6942A	LIFEBUY	SIP MODULE	ENF	27	10	Pb-Free (RoHS)	Call TI	N / A for Pkg Type	
PT6942C	LIFEBUY	SIP MODULE	ENG	27	10	Pb-Free (RoHS)	Call TI	Level-3-215C-168HRS	
PT6943A	LIFEBUY	SIP MODULE	ENF	27	10	Pb-Free (RoHS)	Call TI	N / A for Pkg Type	
PT6943C	LIFEBUY	SIP MODULE	ENG	27	10	Pb-Free (RoHS)	Call TI	Level-3-215C-168HRS	
PT6944A	LIFEBUY	SIP MODULE	ENF	27	10	Pb-Free (RoHS)	Call TI	N / A for Pkg Type	
PT6944C	LIFEBUY	SIP MODULE	ENG	27	10	Pb-Free (RoHS)	Call TI	Level-3-215C-168HRS	
PT6944N	LIFEBUY	SIP MODULE	ENE	27	10	Pb-Free (RoHS)	Call TI	N / A for Pkg Type	
PT6947A	LIFEBUY	SIP MODULE	ENF	27	10	Pb-Free (RoHS)	Call TI	N / A for Pkg Type	
PT6947C	LIFEBUY	SIP MODULE	ENG	27	10	Pb-Free (RoHS)	Call TI	Level-3-215C-168HRS	

⁽¹⁾ The marketing status values are defined as follows:

ACTIVE: Product device recommended for new designs.

LIFEBUY: TI has announced that the device will be discontinued, and a lifetime-buy period is in effect.

NRND: Not recommended for new designs. Device is in production to support existing customers, but TI does not recommend using this part in a new design.

PREVIEW: Device has been announced but is not in production. Samples may or may not be available.

OBSOLETE: TI has discontinued the production of the device.

⁽²⁾ Eco Plan - The planned eco-friendly classification: Pb-Free (RoHS), Pb-Free (RoHS Exempt), or Green (RoHS & no Sb/Br) - please check <http://www.ti.com/productcontent> for the latest availability information and additional product content details.

TBD: The Pb-Free/Green conversion plan has not been defined.

Pb-Free (RoHS): TI's terms "Lead-Free" or "Pb-Free" mean semiconductor products that are compatible with the current RoHS requirements for all 6 substances, including the requirement that lead not exceed 0.1% by weight in homogeneous materials. Where designed to be soldered at high temperatures, TI Pb-Free products are suitable for use in specified lead-free processes.

Pb-Free (RoHS Exempt): This component has a RoHS exemption for either 1) lead-based flip-chip solder bumps used between the die and package, or 2) lead-based die adhesive used between the die and leadframe. The component is otherwise considered Pb-Free (RoHS compatible) as defined above.

Green (RoHS & no Sb/Br): TI defines "Green" to mean Pb-Free (RoHS compatible), and free of Bromine (Br) and Antimony (Sb) based flame retardants (Br or Sb do not exceed 0.1% by weight in homogeneous material)

⁽³⁾ MSL, Peak Temp. -- The Moisture Sensitivity Level rating according to the JEDEC industry standard classifications, and peak solder temperature.

Important Information and Disclaimer: The information provided on this page represents TI's knowledge and belief as of the date that it is provided. TI bases its knowledge and belief on information provided by third parties, and makes no representation or warranty as to the accuracy of such information. Efforts are underway to better integrate information from third parties. TI has taken and continues to take reasonable steps to provide representative and accurate information but may not have conducted destructive testing or chemical analysis on incoming materials and chemicals. TI and TI suppliers consider certain information to be proprietary, and thus CAS numbers and other limited information may not be available for release.

In no event shall TI's liability arising out of such information exceed the total purchase price of the TI part(s) at issue in this document sold by TI to Customer on an annual basis.

IMPORTANT NOTICE

Texas Instruments Incorporated and its subsidiaries (TI) reserve the right to make corrections, enhancements, improvements and other changes to its semiconductor products and services per JESD46, latest issue, and to discontinue any product or service per JESD48, latest issue. Buyers should obtain the latest relevant information before placing orders and should verify that such information is current and complete. All semiconductor products (also referred to herein as "components") are sold subject to TI's terms and conditions of sale supplied at the time of order acknowledgment.

TI warrants performance of its components to the specifications applicable at the time of sale, in accordance with the warranty in TI's terms and conditions of sale of semiconductor products. Testing and other quality control techniques are used to the extent TI deems necessary to support this warranty. Except where mandated by applicable law, testing of all parameters of each component is not necessarily performed.

TI assumes no liability for applications assistance or the design of Buyers' products. Buyers are responsible for their products and applications using TI components. To minimize the risks associated with Buyers' products and applications, Buyers should provide adequate design and operating safeguards.

TI does not warrant or represent that any license, either express or implied, is granted under any patent right, copyright, mask work right, or other intellectual property right relating to any combination, machine, or process in which TI components or services are used. Information published by TI regarding third-party products or services does not constitute a license to use such products or services or a warranty or endorsement thereof. Use of such information may require a license from a third party under the patents or other intellectual property of the third party, or a license from TI under the patents or other intellectual property of TI.

Reproduction of significant portions of TI information in TI data books or data sheets is permissible only if reproduction is without alteration and is accompanied by all associated warranties, conditions, limitations, and notices. TI is not responsible or liable for such altered documentation. Information of third parties may be subject to additional restrictions.

Resale of TI components or services with statements different from or beyond the parameters stated by TI for that component or service voids all express and any implied warranties for the associated TI component or service and is an unfair and deceptive business practice. TI is not responsible or liable for any such statements.

Buyer acknowledges and agrees that it is solely responsible for compliance with all legal, regulatory and safety-related requirements concerning its products, and any use of TI components in its applications, notwithstanding any applications-related information or support that may be provided by TI. Buyer represents and agrees that it has all the necessary expertise to create and implement safeguards which anticipate dangerous consequences of failures, monitor failures and their consequences, lessen the likelihood of failures that might cause harm and take appropriate remedial actions. Buyer will fully indemnify TI and its representatives against any damages arising out of the use of any TI components in safety-critical applications.

In some cases, TI components may be promoted specifically to facilitate safety-related applications. With such components, TI's goal is to help enable customers to design and create their own end-product solutions that meet applicable functional safety standards and requirements. Nonetheless, such components are subject to these terms.

No TI components are authorized for use in FDA Class III (or similar life-critical medical equipment) unless authorized officers of the parties have executed a special agreement specifically governing such use.

Only those TI components which TI has specifically designated as military grade or "enhanced plastic" are designed and intended for use in military/aerospace applications or environments. Buyer acknowledges and agrees that any military or aerospace use of TI components which have **not** been so designated is solely at the Buyer's risk, and that Buyer is solely responsible for compliance with all legal and regulatory requirements in connection with such use.

TI has specifically designated certain components as meeting ISO/TS16949 requirements, mainly for automotive use. In any case of use of non-designated products, TI will not be responsible for any failure to meet ISO/TS16949.

Products

Audio	www.ti.com/audio
Amplifiers	amplifier.ti.com
Data Converters	dataconverter.ti.com
DLP® Products	www.dlp.com
DSP	dsp.ti.com
Clocks and Timers	www.ti.com/clocks
Interface	interface.ti.com
Logic	logic.ti.com
Power Mgmt	power.ti.com
Microcontrollers	microcontroller.ti.com
RFID	www.ti-rfid.com
OMAP Applications Processors	www.ti.com/omap
Wireless Connectivity	www.ti.com/wirelessconnectivity

Applications

Automotive and Transportation	www.ti.com/automotive
Communications and Telecom	www.ti.com/communications
Computers and Peripherals	www.ti.com/computers
Consumer Electronics	www.ti.com/consumer-apps
Energy and Lighting	www.ti.com/energy
Industrial	www.ti.com/industrial
Medical	www.ti.com/medical
Security	www.ti.com/security
Space, Avionics and Defense	www.ti.com/space-avionics-defense
Video and Imaging	www.ti.com/video

TI E2E Community

e2e.ti.com