

- Wide Input Voltage Range: +8V to +25V
- Negative Output: -2.5V/4A to -15V/1.5A
- Adjustable Output Voltage
- 85% Efficiency
- Remote Sense Capability

The PT6640 series is a positive input to negative output line of Integrated Switching Regulators (ISRs). Designed for general purpose applications, the PT6640 series delivers a negative output voltage at up to 24W. The PT6640 is packaged in a 14-Pin SIP (Single In-line Package) and is available in a surface-mount configuration.

### Standard Application

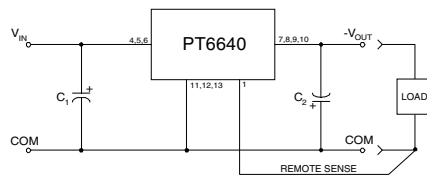

C<sub>1</sub> = Required 560µF electrolytic  
C<sub>2</sub> = Required 330µF electrolytic

### Pin-Out Information

1	Remote Sense
2	Do Not Connect
3	Do Not Connect
4	+V <sub>in</sub>
5	+V <sub>in</sub>
6	+V <sub>in</sub>
7	-V <sub>out</sub>
8	-V <sub>out</sub>
9	-V <sub>out</sub>
10	-V <sub>out</sub>
11	GND
12	GND
13	GND
14	V <sub>out</sub> Adjust

### Ordering Information

PT6641□	= -3.3 Volts
PT6642□	= -5.0 Volts
PT6643□	= -12.0 Volts
PT6644□	= -9.0 Volts
PT6645□	= -15.0 Volts
PT6646□	= -2.5 Volts

### PT Series Suffix (PT1234X)

Case/Pin Configuration	Heat Spreader
Vertical Through-Hole	<b>P</b>
Horizontal Through-Hole	<b>D</b>
Horizontal Surface Mount	<b>E</b>

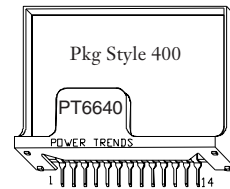

Note: Back surface of product is conducting metal

### Specifications

Characteristics (T <sub>a</sub> = 25°C unless noted)	Symbols	Conditions	PT6640 SERIES			Units
			Min	Typ	Max	
Output Current	I <sub>o</sub>	T <sub>a</sub> = 60°C, 200 LFM, pkg P T <sub>a</sub> = 25°C, natural convection	0.1 0.1 0.1 0.1 0.1	— — — — —	(See Note 2) 4.0 2.5 2.0 1.5	A
Input Voltage Range	V <sub>in</sub>	0.1A ≤ I <sub>o</sub> ≤ I <sub>o</sub> max V <sub>o</sub> = -2.5V/3.3V V <sub>o</sub> = -5.0V V <sub>o</sub> = -9.0V V <sub>o</sub> = -12.0V V <sub>o</sub> = -15.0V	+8 +8 +8 +8 +8	— — — — —	+27 +25 +21 +18 +15	V
Output Voltage Tolerance	ΔV <sub>o</sub>	Over V <sub>in</sub> range T <sub>a</sub> = -40°C to +65°C	V <sub>o</sub> -0.1	—	V <sub>o</sub> +0.1	V
Output Voltage Adjust Range	V <sub>oadj</sub>	Pin 14 to V <sub>o</sub> or ground V <sub>o</sub> = -2.5V V <sub>o</sub> = -3.3V V <sub>o</sub> = -5.0V V <sub>o</sub> = -9.0V V <sub>o</sub> = -12.0V V <sub>o</sub> = -15.0V	-1.8 -2.2 -3.0 -6.0 -9.0 -10.0	— — — — — —	-4.3 -4.7 -6.5 -10.2 -13.6 -17.0	V
Line Regulation	Reg <sub>line</sub>	+9V ≤ V <sub>in</sub> ≤ +V <sub>in</sub> max, I <sub>o</sub> = I <sub>o</sub> max	—	±0.5	±1.0	%V <sub>o</sub>
Load Regulation	Reg <sub>load</sub>	V <sub>in</sub> = +12V, 0.1 ≤ I <sub>o</sub> ≤ I <sub>o</sub> max	—	±0.5	±1.0	%V <sub>o</sub>
V <sub>o</sub> Ripple/Noise	V <sub>n</sub>	V <sub>in</sub> = +12V, I <sub>o</sub> = I <sub>o</sub> max	—	3.0	—	%V <sub>o</sub>
Transient Response with C <sub>2</sub> = 330µF	t <sub>tr</sub> V <sub>os</sub>	I <sub>o</sub> step between 0.5xI <sub>o</sub> max and I <sub>o</sub> max V <sub>o</sub> over/undershoot	— —	200 100	— —	µSec mV
Efficiency	η	V <sub>in</sub> = +12V, I <sub>o</sub> = 0.5x I <sub>o</sub> max	— — — — —	75 79 83 85 84	— — — — —	%
		V <sub>in</sub> = +12V, I <sub>o</sub> = I <sub>o</sub> max	— — — —	74 77 80 84	— — — —	%

Continued

# PT6640 Series

## 24W 12V Input Positive to Negative Voltage Converter

### Specifications (continued)

Characteristics ( $T_a = 25^\circ\text{C}$ unless noted)	Symbols	Conditions	PT6640 SERIES			Units
			Min	Typ	Max	
Switching Frequency	$f_o$	$+9\text{V} \leq V_{in} \leq V_{in,max}$ Over $I_o$ range	500	550	600	kHz
Absolute Maximum Operating Temperature Range	$T_a$	Over $V_{in}$ range	-40	—	+85 <sup>(2)</sup>	$^\circ\text{C}$
Storage Temperature	$T_s$	—	-40	—	+125	$^\circ\text{C}$
Mechanical Shock	—	Per Mil-STD-883D, Method 2002.3	—	500	—	G's
Mechanical Vibration	—	Per Mil-STD-883D, Method 2007.2, 20-2000 Hz, soldered in a PC board	—	7.5	—	G's
Weight	—	—	—	14	—	grams

**Notes:** (1) The PT6640 Series requires a 330 $\mu\text{F}$ (output) and 560 $\mu\text{F}$ (input) electrolytic capacitors for proper operation in all applications.  
(2) See Safe Operating Area curves or call the factory for guidance on thermal derating.

## TYPICAL CHARACTERISTICS

Characteristic Curves @12.0V  $V_{in}$  (See Note A)

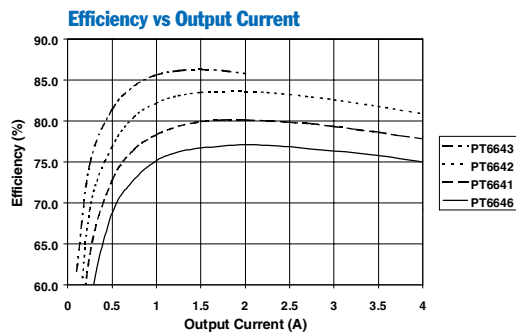

Safe Operating Area Curves (See Note B)

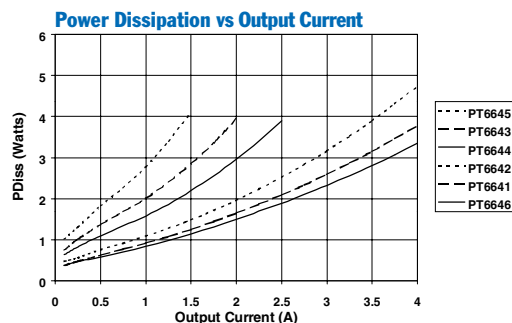
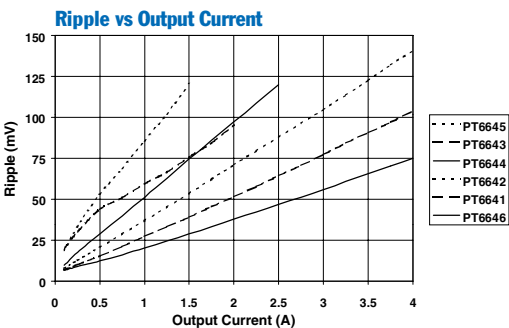
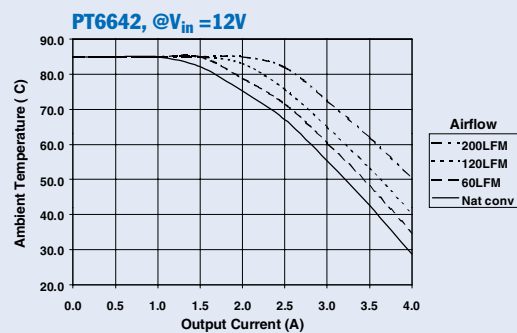

**Note A:** Characteristic data has been developed from actual products tested at 25°C. This data is considered typical data for the DC-DC Converter.

**Note B:** SOA curves represent operating conditions at which internal components are at or below manufacturer's maximum rated operating temperatures.

## Adjusting the Output Voltage of the PT6640 24W Positive to Negative ISR Series

The negative output voltage of the Power Trends PT6640 series ISRs may be adjusted higher or lower than the factory trimmed pre-set voltage with the addition of a single external resistor. Table 1 gives the allowable adjustment range for each model in the series as  $V_a$  (min) and  $V_a$  (max).

**Adjust Up:** An increase in the negative output voltage is obtained by adding a resistor R2, between pin 14 ( $V_o$  adjust) and pins 7-10 ( $-V_{out}$ ).

**Adjust Down:** Adding a resistor (R1), between pin 14 ( $V_o$  adjust) and pins 11-13 (GND), decreases the output voltage magnitude.

Refer to Figure 1 and Table 2 for both the placement and value of the required resistor, either (R1) or R2 as appropriate.

### Notes:

1. Use only a single 1% resistor in either the (R1) or R2 location. Place the resistor as close to the ISR as possible.
2. Never connect capacitors from  $V_o$  adjust to either GND,  $V_{out}$ , or the Remote Sense pin. Any capacitance added to the  $V_o$  adjust pin will affect the stability of the ISR.
3. If the Remote Sense feature is being used, connecting the resistor (R1) between pin 14 ( $V_o$  adjust) and pin 1 (Remote Sense) can benefit load regulation.
4. The maximum allowed input voltage ( $V_{in}$ ) will change as  $V_{out}$  is adjusted. The difference between the input voltage ( $V_{in}$ ) and the output voltage ( $V_{out}$ ) must not exceed 30V or  $10 \times V_{out}$ , whichever is less. Use one of the following formulas to determine the maximum allowed input voltage for the PT6640.

$$\begin{aligned} &|V_{out}| \text{ greater than } 2.73V, \\ V_{in}(\text{max}) &= 30 - |V_{out}| \quad \text{Vdc} \end{aligned}$$

For example, if  $V_{out} = -12V$ ,

$$V_{in}(\text{max}) = 30 - |-12| = 18Vdc$$

$$\begin{aligned} &|V_{out}| \text{ less than } 2.73V, \\ V_{in}(\text{max}) &= 10 \times |V_{out}| \quad \text{Vdc} \end{aligned}$$

Figure 1

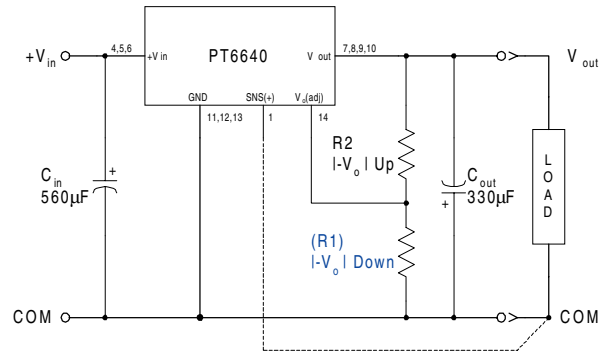

The values of (R1) [adjust down], and R2 [adjust up], can also be calculated using the following formulas.

$$(R1) = \frac{R_o (V_o - 1.25)(V_a - 1.25)}{1.25 (V_o - V_a)} - R_s \quad \text{k}\Omega$$

$$R2 = \frac{R_o (V_o - 1.25)}{V_a - V_o} - R_s \quad \text{k}\Omega$$

Where:  $V_o$  = Original  $V_{out}$  (magnitude)  
 $V_a$  = Adjusted  $V_{out}$  (magnitude)  
 $R_o$  = The resistance value in Table 1  
 $R_s$  = The series resistance from Table 1

Table 1

### PT6640 ADJUSTMENT AND FORMULA PARAMETERS

Series Pt #	PT6646	PT6641	PT6642	PT6644	PT6643	PT6645
$V_o$ (nom)	-2.5V	-3.3V	-5.0V	-9.0V	-12.0V	-15.0V
$V_a$ (min)	-1.8V	-2.2V	-3.0V	-6.0V	-9.0V	-10.0V
$V_a$ (max)	-4.3V	-4.7V	-6.5V	-10.2V	-13.6V	-17.0V
$R_o$ (k $\Omega$ )	4.99	4.22	2.49	2.0	2.0	2.0
$R_s$ (k $\Omega$ )	2.49	4.99	4.99	12.7	12.7	12.7

PT6640 Series

Table 2

PT6640 ADJUSTMENT RESISTOR VALUES

Series Pt #	PT6646	PT6641	PT6642	Series Pt #	PT6644	PT6643	PT6645
Current	4Adc	4Adc	4Adc	Current	2.5Adc	2Adc	1.5Adc
V <sub>o</sub> (nom)	-2.5Vdc	-3.3Vdc	-5.0Vdc	V <sub>o</sub> (nom)	-9.0Vdc	-12.0Vdc	-15.0Vdc
V <sub>a</sub> (req'd)				V <sub>a</sub> (req'd)			
-1.8	(1.4)kΩ			-6.0	(6.9)kΩ		
-1.9	(2.9)kΩ			-6.2	(9.2)kΩ		
-2.0	(5.0)kΩ			-6.4	(11.9)kΩ		
-2.1	(8.1)kΩ			-6.6	(14.0)kΩ		
-2.2	(13.3)kΩ	(1.0)kΩ		-6.8	(18.6)kΩ		
-2.3	(23.7)kΩ	(2.3)kΩ		-7.0	(23.0)kΩ		
-2.4	(54.9)kΩ	(3.9)kΩ		-7.2	(28.3)kΩ		
-2.5		(5.8)kΩ		-7.4	(35.0)kΩ		
-2.6	59.9kΩ	(8.4)kΩ		-7.6	(43.5)kΩ		
-2.7	28.7kΩ	(11.7)kΩ		-7.8	(55.0)kΩ		
-2.8	18.3kΩ	(16.5)kΩ		-8.0	(71.0)kΩ		
-2.9	13.1kΩ	(23.6)kΩ		-8.2	(95.0)kΩ		
-3.0	10.0kΩ	(35.4)kΩ	(1.6)kΩ	-8.4	(135.0)kΩ		
-3.1	7.9kΩ	(59.0)kΩ	(2.3)kΩ	-8.6	(215.0)kΩ		
-3.2	6.4kΩ	(130.0)kΩ	(3.1)kΩ	-8.8	(455.0)kΩ		
-3.3	5.3kΩ		(4.0)kΩ	-9.0		(31.7)kΩ	
-3.4	4.4kΩ	81.5kΩ	(5.1)kΩ	-9.2	64.8kΩ	(36.1)kΩ	
-3.5	3.8kΩ	38.3kΩ	(6.2)kΩ	-9.4	26.1kΩ	(41.2)kΩ	
-3.6	3.2kΩ	23.8kΩ	(7.6)kΩ	-9.6	13.1kΩ	(47.1)kΩ	
-3.7	2.7kΩ	16.6kΩ	(9.1)kΩ	-9.8	6.7kΩ	(54.1)kΩ	
-3.8	2.3kΩ	12.3kΩ	(10.9)kΩ	-10.0	2.8kΩ	(62.6)kΩ	(25.8)kΩ
-3.9	2.0kΩ	9.4kΩ	(13.0)kΩ	-10.2	0.2kΩ	(72.8)kΩ	(28.3)kΩ
-4.0	1.7kΩ	7.4kΩ	(15.6)kΩ	-10.4		(85.7)kΩ	(31.1)kΩ
-4.1	1.4kΩ	5.8kΩ	(18.7)kΩ	-10.6		(102.0)kΩ	(34.1)kΩ
-4.2	1.2kΩ	4.6kΩ	(22.6)kΩ	-10.8		(124.0)kΩ	(37.3)kΩ
-4.3	1.0kΩ	3.7kΩ	(27.6)kΩ	-11.0		(155.0)kΩ	(40.9)kΩ
-4.4		2.9kΩ	(34.2)kΩ	-11.2		(201.0)kΩ	(44.9)kΩ
-4.5		2.2kΩ	(43.6)kΩ	-11.4		(278.0)kΩ	(49.3)kΩ
-4.6		1.7kΩ	(57.6)kΩ	-11.6		(432.0)kΩ	(54.3)kΩ
-4.7		1.2kΩ	(80.9)kΩ	-11.8		(895.0)kΩ	(59.8)kΩ
-4.8			(128.0)kΩ	-12.0			(66.1)kΩ
-4.9			(268.0)kΩ	-12.2		94.8kΩ	(73.3)kΩ
-5.0				-12.4		41.1kΩ	(81.6)kΩ
-5.1			88.4kΩ	-12.6		23.1kΩ	(91.3)kΩ
-5.2			41.7kΩ	-12.8		14.2kΩ	(103.0)kΩ
-5.3			26.1kΩ	-13.0		8.8kΩ	(117.0)kΩ
-5.4			18.4kΩ	-13.2		5.2kΩ	(133.0)kΩ
-5.5			13.7kΩ	-13.4		2.7kΩ	(154.0)kΩ
-5.6			10.6kΩ	-13.6		0.7kΩ	(181.0)kΩ
-5.7			8.4kΩ	-13.8			(217.0)kΩ
-5.8			6.7kΩ	-14.0			(268.0)kΩ
-5.9			5.4kΩ	-14.2			(343.0)kΩ
-6.0			4.4kΩ	-14.5			(570.0)kΩ
-6.1			3.5kΩ	-15.0			
-6.2			2.8kΩ	-15.5			42.3kΩ
-6.3			2.2kΩ	-16.0			14.8kΩ
-6.4			1.7kΩ	-16.5			5.6kΩ
-6.5			1.2kΩ	-17.0			1.1kΩ

R1 = (Blue) R2 = Black

**PACKAGING INFORMATION**

Orderable Device	Status (1)	Package Type	Package Drawing	Pins	Package Qty	Eco Plan (2)	Lead/Ball Finish	MSL Peak Temp (3)	Samples (Requires Login)
PT6641P	LIFEBUY	SIP MODULE	EED	14	12	Pb-Free (RoHS)	Call TI	N / A for Pkg Type	
PT6642D	LIFEBUY	SIP MODULE	EEA	14	12	Pb-Free (RoHS)	Call TI	N / A for Pkg Type	
PT6642E	LIFEBUY	SIP MODULE	EEC	14	12	Pb-Free (RoHS)	Call TI	Level-1-215C-UNLIM	
PT6642G	LIFEBUY	SIP MODULE	EEG	14	12	Pb-Free (RoHS)	Call TI	N / A for Pkg Type	
PT6642P	LIFEBUY	SIP MODULE	EED	14	12	Pb-Free (RoHS)	Call TI	N / A for Pkg Type	
PT6643D	LIFEBUY	SIP MODULE	EEA	14	12	Pb-Free (RoHS)	Call TI	N / A for Pkg Type	
PT6643E	LIFEBUY	SIP MODULE	EEC	14	12	Pb-Free (RoHS)	Call TI	Level-1-215C-UNLIM	
PT6643M	LIFEBUY	SIP MODULE	EEM	14	12	Pb-Free (RoHS)	Call TI	N / A for Pkg Type	
PT6643P	LIFEBUY	SIP MODULE	EED	14	12	Pb-Free (RoHS)	Call TI	N / A for Pkg Type	
PT6644D	LIFEBUY	SIP MODULE	EEA	14	12	Pb-Free (RoHS)	Call TI	N / A for Pkg Type	
PT6644E	LIFEBUY	SIP MODULE	EEC	14	12	Pb-Free (RoHS)	Call TI	Level-1-215C-UNLIM	
PT6645D	LIFEBUY	SIP MODULE	EEA	14	12	Pb-Free (RoHS)	Call TI	N / A for Pkg Type	
PT6645E	LIFEBUY	SIP MODULE	EEC	14	12	Pb-Free (RoHS)	Call TI	Level-1-215C-UNLIM	
PT6645F	LIFEBUY	SIP MODULE	EEF	14	12	Pb-Free (RoHS)	Call TI	Level-1-215C-UNLIM	
PT6645G	LIFEBUY	SIP MODULE	EEG	14	12	Pb-Free (RoHS)	Call TI	N / A for Pkg Type	
PT6645P	LIFEBUY	SIP MODULE	EED	14	12	Pb-Free (RoHS)	Call TI	N / A for Pkg Type	
PT6646E	LIFEBUY	SIP MODULE	EEC	14	12	Pb-Free (RoHS)	Call TI	Level-1-215C-UNLIM	

(1) The marketing status values are defined as follows:

**ACTIVE:** Product device recommended for new designs.

**LIFEBUY:** TI has announced that the device will be discontinued, and a lifetime-buy period is in effect.

**NRND:** Not recommended for new designs. Device is in production to support existing customers, but TI does not recommend using this part in a new design.

**PREVIEW:** Device has been announced but is not in production. Samples may or may not be available.

**OBSELETE:** TI has discontinued the production of the device.

(2) Eco Plan - The planned eco-friendly classification: Pb-Free (RoHS), Pb-Free (RoHS Exempt), or Green (RoHS & no Sb/Br) - please check <http://www.ti.com/productcontent> for the latest availability information and additional product content details.

**TBD:** The Pb-Free/Green conversion plan has not been defined.

**Pb-Free (RoHS):** TI's terms "Lead-Free" or "Pb-Free" mean semiconductor products that are compatible with the current RoHS requirements for all 6 substances, including the requirement that lead not exceed 0.1% by weight in homogeneous materials. Where designed to be soldered at high temperatures, TI Pb-Free products are suitable for use in specified lead-free processes.

**Pb-Free (RoHS Exempt):** This component has a RoHS exemption for either 1) lead-based flip-chip solder bumps used between the die and package, or 2) lead-based die adhesive used between the die and leadframe. The component is otherwise considered Pb-Free (RoHS compatible) as defined above.

**Green (RoHS & no Sb/Br):** TI defines "Green" to mean Pb-Free (RoHS compatible), and free of Bromine (Br) and Antimony (Sb) based flame retardants (Br or Sb do not exceed 0.1% by weight in homogeneous material)

(3) MSL, Peak Temp. -- The Moisture Sensitivity Level rating according to the JEDEC industry standard classifications, and peak solder temperature.

**Important Information and Disclaimer:** The information provided on this page represents TI's knowledge and belief as of the date that it is provided. TI bases its knowledge and belief on information provided by third parties, and makes no representation or warranty as to the accuracy of such information. Efforts are underway to better integrate information from third parties. TI has taken and continues to take reasonable steps to provide representative and accurate information but may not have conducted destructive testing or chemical analysis on incoming materials and chemicals. TI and TI suppliers consider certain information to be proprietary, and thus CAS numbers and other limited information may not be available for release.

In no event shall TI's liability arising out of such information exceed the total purchase price of the TI part(s) at issue in this document sold by TI to Customer on an annual basis.

## IMPORTANT NOTICE

Texas Instruments Incorporated and its subsidiaries (TI) reserve the right to make corrections, enhancements, improvements and other changes to its semiconductor products and services per JESD46, latest issue, and to discontinue any product or service per JESD48, latest issue. Buyers should obtain the latest relevant information before placing orders and should verify that such information is current and complete. All semiconductor products (also referred to herein as "components") are sold subject to TI's terms and conditions of sale supplied at the time of order acknowledgment.

TI warrants performance of its components to the specifications applicable at the time of sale, in accordance with the warranty in TI's terms and conditions of sale of semiconductor products. Testing and other quality control techniques are used to the extent TI deems necessary to support this warranty. Except where mandated by applicable law, testing of all parameters of each component is not necessarily performed.

TI assumes no liability for applications assistance or the design of Buyers' products. Buyers are responsible for their products and applications using TI components. To minimize the risks associated with Buyers' products and applications, Buyers should provide adequate design and operating safeguards.

TI does not warrant or represent that any license, either express or implied, is granted under any patent right, copyright, mask work right, or other intellectual property right relating to any combination, machine, or process in which TI components or services are used. Information published by TI regarding third-party products or services does not constitute a license to use such products or services or a warranty or endorsement thereof. Use of such information may require a license from a third party under the patents or other intellectual property of the third party, or a license from TI under the patents or other intellectual property of TI.

Reproduction of significant portions of TI information in TI data books or data sheets is permissible only if reproduction is without alteration and is accompanied by all associated warranties, conditions, limitations, and notices. TI is not responsible or liable for such altered documentation. Information of third parties may be subject to additional restrictions.

Resale of TI components or services with statements different from or beyond the parameters stated by TI for that component or service voids all express and any implied warranties for the associated TI component or service and is an unfair and deceptive business practice. TI is not responsible or liable for any such statements.

Buyer acknowledges and agrees that it is solely responsible for compliance with all legal, regulatory and safety-related requirements concerning its products, and any use of TI components in its applications, notwithstanding any applications-related information or support that may be provided by TI. Buyer represents and agrees that it has all the necessary expertise to create and implement safeguards which anticipate dangerous consequences of failures, monitor failures and their consequences, lessen the likelihood of failures that might cause harm and take appropriate remedial actions. Buyer will fully indemnify TI and its representatives against any damages arising out of the use of any TI components in safety-critical applications.

In some cases, TI components may be promoted specifically to facilitate safety-related applications. With such components, TI's goal is to help enable customers to design and create their own end-product solutions that meet applicable functional safety standards and requirements. Nonetheless, such components are subject to these terms.

No TI components are authorized for use in FDA Class III (or similar life-critical medical equipment) unless authorized officers of the parties have executed a special agreement specifically governing such use.

Only those TI components which TI has specifically designated as military grade or "enhanced plastic" are designed and intended for use in military/aerospace applications or environments. Buyer acknowledges and agrees that any military or aerospace use of TI components which have **not** been so designated is solely at the Buyer's risk, and that Buyer is solely responsible for compliance with all legal and regulatory requirements in connection with such use.

TI has specifically designated certain components as meeting ISO/TS16949 requirements, mainly for automotive use. In any case of use of non-designated products, TI will not be responsible for any failure to meet ISO/TS16949.

### Products

Audio	<a href="http://www.ti.com/audio">www.ti.com/audio</a>
Amplifiers	<a href="http://amplifier.ti.com">amplifier.ti.com</a>
Data Converters	<a href="http://dataconverter.ti.com">dataconverter.ti.com</a>
DLP® Products	<a href="http://www.dlp.com">www.dlp.com</a>
DSP	<a href="http://dsp.ti.com">dsp.ti.com</a>
Clocks and Timers	<a href="http://www.ti.com/clocks">www.ti.com/clocks</a>
Interface	<a href="http://interface.ti.com">interface.ti.com</a>
Logic	<a href="http://logic.ti.com">logic.ti.com</a>
Power Mgmt	<a href="http://power.ti.com">power.ti.com</a>
Microcontrollers	<a href="http://microcontroller.ti.com">microcontroller.ti.com</a>
RFID	<a href="http://www.ti-rfid.com">www.ti-rfid.com</a>
OMAP Applications Processors	<a href="http://www.ti.com/omap">www.ti.com/omap</a>
Wireless Connectivity	<a href="http://www.ti.com/wirelessconnectivity">www.ti.com/wirelessconnectivity</a>

### Applications

Automotive and Transportation	<a href="http://www.ti.com/automotive">www.ti.com/automotive</a>
Communications and Telecom	<a href="http://www.ti.com/communications">www.ti.com/communications</a>
Computers and Peripherals	<a href="http://www.ti.com/computers">www.ti.com/computers</a>
Consumer Electronics	<a href="http://www.ti.com/consumer-apps">www.ti.com/consumer-apps</a>
Energy and Lighting	<a href="http://www.ti.com/energy">www.ti.com/energy</a>
Industrial	<a href="http://www.ti.com/industrial">www.ti.com/industrial</a>
Medical	<a href="http://www.ti.com/medical">www.ti.com/medical</a>
Security	<a href="http://www.ti.com/security">www.ti.com/security</a>
Space, Avionics and Defense	<a href="http://www.ti.com/space-avionics-defense">www.ti.com/space-avionics-defense</a>
Video and Imaging	<a href="http://www.ti.com/video">www.ti.com/video</a>

### TI E2E Community

[e2e.ti.com](http://e2e.ti.com)