

- Adjustable Output Voltage
- 85% Efficiency
- Small SIP Footprint
- Input Voltage Range: 4.5V to 5.5V
- Remote Sense Capability

The PT6420 series from Power Trends is a high performance +5V to +3.3V, 3Amp family of 14-Pin SIP (Single In-line Package) Integrated Switching Regulators (ISRs). Only two external capacitors are required for proper operation.

Please note that this product does not include short circuit protection.

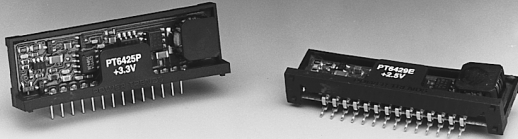

Standard Application

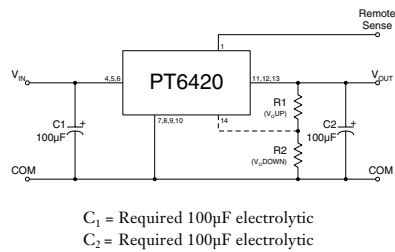

Pin-Out Information

Pin	Function
1	Remote Sense
2	Do not connect
3	Do not connect
4	V _{in}
5	V _{in}
6	V _{in}
7	GND
8	GND
9	GND
10	GND
11	V _{out}
12	V _{out}
13	V _{out}
14	V _{out} Adjust

Ordering Information

- PT6424□ = +1.5 Volts
- PT6425□ = +3.3 Volts
- PT6426□ = +1.8 Volts
- PT6427□ = +2.1 Volts
- PT6428□ = +1.2 Volts
- PT6429□ = +2.5 Volts

PT Series Suffix (PT1234X)

Case/Pin Configuration	Suffix
Vertical Through-Hole	P
Horizontal Through-Hole	D
Horizontal Surface Mount	E

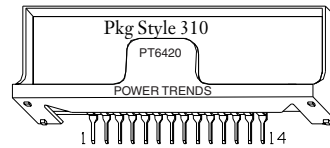

Note: Back surface of product is conducting metal.

Specifications

Characteristics (T _a = 25°C unless noted)	Symbols	Conditions	PT6420 SERIES			Units
			Min	Typ	Max	
Output Current	I _o	4.5V ≤ V _{in} ≤ 5.5V	0	—	3.0	A
Current Limit	I _{cl}	V _{in} = +5V	—	3.6	5.0	A
Input Voltage Range	V _{in}	0.1A ≤ I _o ≤ 3.0A	4.5	—	5.5	V
Output Voltage Tolerance	ΔV _o	V _{in} = +5V, I _o = 3.0A 0°C ≤ T _a ≤ +70°C	V _o -0.05	3.3	V _o +0.05	V
Line Regulation	Reg _{line}	4.5V ≤ V _{in} ≤ 5.5V, I _o = 3.0A	—	±10	±25	mV
Load Regulation	Reg _{load}	V _{in} = +5V, 0.3 ≤ I _o ≤ 3.0A	—	±10*	±25*	mV
V _o Ripple/Noise	V _n	V _{in} = 5V, I _o = 3.0A	—	66	165	mVpp
Transient Response with C ₂ = 100µF	t _{tr} V _{os}	I _o step between 1.5A and 3.0A V _o over/undershoot	— —	200 200	— —	µSec mV
Efficiency	η	V _{in} = +5V, I _o = 1.5A V _o = 3.3V V _o = 1.8V V _o = 2.1V V _o = 1.2V	— — — —	85 74 77 63	— — — —	% % % %
Switching Frequency	f _o	4.5V ≤ V _{in} ≤ 5.5V 0.3A ≤ I _o ≤ 3.0A	500	650	800	kHz
Absolute Maximum Operating Temperature Range	T _a		0	—	+85	°C
Recommended Operating Temperature Range	T _a	Free Air Convection (40-60 LFM) At Vin= 5V, Io=2.5A	0	—	+70**	°C
Thermal Resistance	θ _{ja}	Free Air Convection (40-60 LFM)	—	25	—	°C/W
Storage Temperature	T _s		-40	—	+125	°C
Mechanical Shock		Per Mil-STD-883D, Method 2002.3, 1 msec, Half Sine, mounted to a fixture	—	500	—	G's
Mechanical Vibration		Per Mil-STD-883D, Method 2007.2, 20-2000 Hz, Soldered in a PC board	—	15	—	G's
Weight	—	—	—	6.5	—	grams

*When used with remote sense function.

**See Thermal Derating chart.

Note: The PT6420 Series requires two 100µF electrolytic or tantalum capacitors for proper operation in all applications.

3 Amp 5V Input Adjustable Integrated Switching Regulator

PT6428 1.2 VDC (See Note 1)

Efficiency vs Output Current

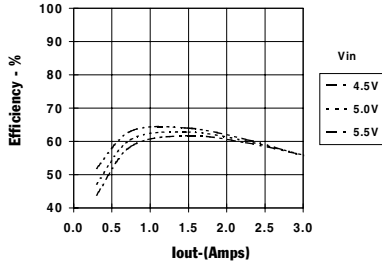

Ripple vs Output Current

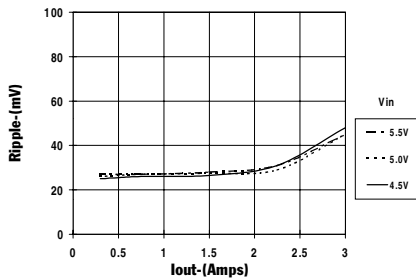

Thermal Derating (Ta) (See Note 2)

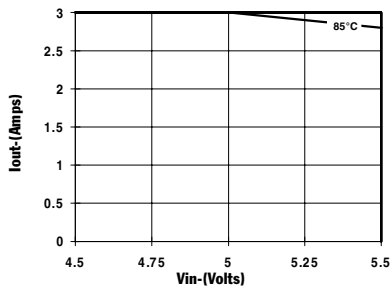

Power Dissipation vs Output Current

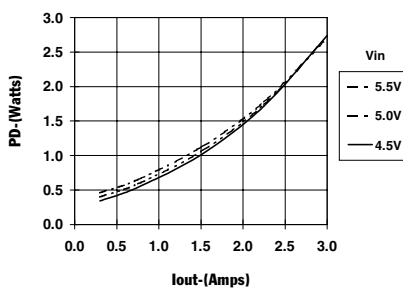

PT6427, 2.1 VDC (See Note 1)

Efficiency vs Output Current

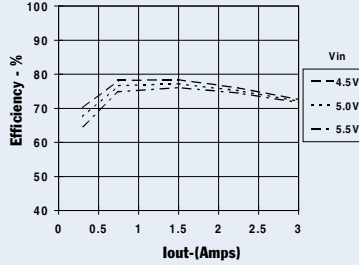

Ripple vs Output Current

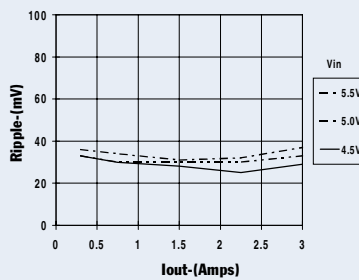

Thermal Derating (Ta) (See Note 2)

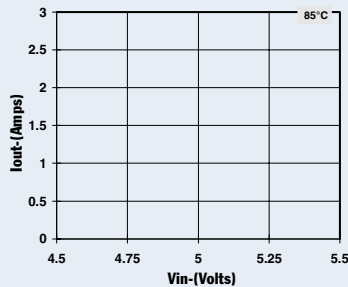

Power Dissipation vs Output Current

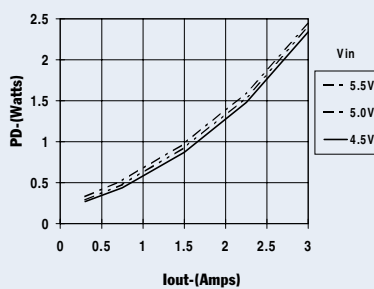

PT6425, 3.3 VDC (See Note 1)

Efficiency vs Output Current

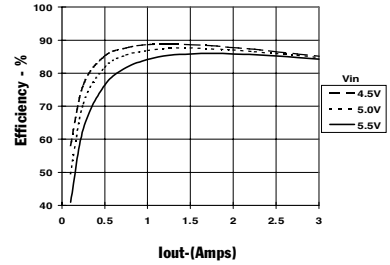

Ripple vs Output Current

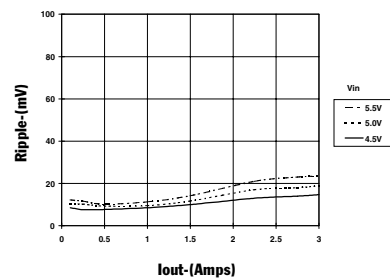

Thermal Derating (Ta) (See Note 2)

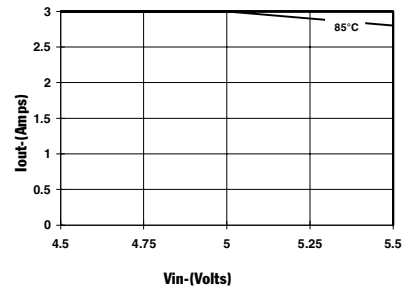

Power Dissipation vs Output Current

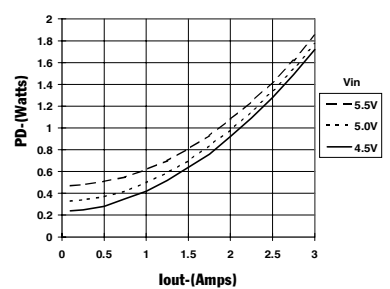

Note 1: All data listed in the above graphs except for derating data has been developed from actual products tested at 25°C. This data is considered typical data for the ISR.
Note 2: Thermal derating graphs are developed in free air convection cooling of 40-60 LFM. (See Thermal Application Notes.)

Adjusting the Output Voltage of the PT6420 Series 3AMP 5V Bus Converters

The output voltage of the Power Trends PT6420 Series ISRs may be adjusted higher or lower than the factory trimmed pre-set voltage with the addition of a single external resistor. Table 1 accordingly gives the allowable adjustment range for each model in the series as V_a (min) and V_a (max).

Adjust Up: (See note 1) An increase in the output voltage is obtained by adding a resistor R1, between pin 14 (V_o adjust) and pins 11-13 (V_{out}).

Adjust Down: (See note 1) Add a resistor (R2), between pin 14 (V_o adjust) and pins 7-10 (GND).

Refer to Figure 1 and Table 2 for both the placement and value of the required resistor; either R1 or (R2) as appropriate.

Notes:

1. The direction in which each resistor adjusts the output of the PT6420 series differs from many other Power Trends products. These output voltage adjustment notes are therefore specific only to the PT6420 models.
2. Use only a single 1% resistor in either the R1 or (R2) location. Place the resistor as close to the ISR as possible.
3. Never connect capacitors from V_o adjust to either GND, V_{out} , or the Remote Sense pin. Any capacitance added to the V_o adjust pin will affect the stability of the ISR.
4. The PT6420 incorporates a Remote Sense (See Figure 1). If this feature is being used, connecting the resistor R1 between pin 14 (V_o adjust) and pin 1 (Remote Sense) can benefit load regulation.
5. An increase in the output voltage may place additional limits on the input voltage range of the part. The revised minimum input voltage will be ($V_{out} + 1.2$) or 4.5V, whichever is higher. Do not exceed 5.5Vdc.

Figure 1

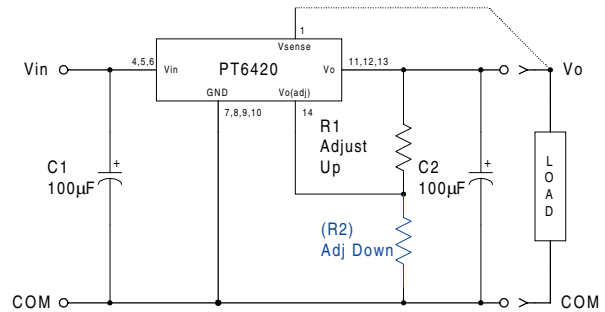

The values of R1 [adjust up], and (R2) [adjust down], can also be calculated using the following formulae.

$$R1 = \frac{12.45 V_o}{(V_a - V_o)} - 49.9 \quad \text{k}\Omega$$

$$(R2) = \frac{12.45 (2V_a - V_o)}{V_o - V_a} - 49.9 \quad \text{k}\Omega$$

Where: V_o = Original output voltage
 V_a = Adjusted output voltage

Table 1

PT6420 ADJUSTMENT RANGE

Series Pt #	PT6428	PT6424	PT6426	PT6427	PT6429	PT6425
V_o (nom)	1.2	1.5	1.8	2.1	2.5	3.3
V_a (min)	1.1	1.3	1.5	1.8	2.1	2.8
V_a (max)	1.4	1.8	2.2	2.6	3.1	3.8

PT6420 Series

Table 2

PT6420 ADJUSTMENT RESISTOR VALUES

Series Pt #	PT6428	PT6424	PT6426	PT6427	PT6429	PT6425
V ₀ (nom)	1.2	1.5	1.8	2.1	2.5	3.3
V _a (req'd)						
1.1	(74.6)kΩ					
1.15	(224.0)kΩ					
1.2						
1.25	249.0kΩ					
1.3	99.5kΩ	(18.6)kΩ				
1.35	49.7kΩ	(49.7)kΩ				
1.4	24.8kΩ	(112.0)kΩ				
1.45		(299.0)kΩ				
1.5			(0.0)kΩ			
1.55		324.0kΩ	(14.8)kΩ			
1.6		137.0kΩ	(37.3)kΩ			
1.65		74.6kΩ	(74.6)kΩ			
1.7		43.5kΩ	(149.0)kΩ			
1.75		24.8kΩ	(373.0)kΩ			
1.8		12.4kΩ		(12.4)kΩ		
1.85			398.0kΩ	(29.8)kΩ		
1.9			174.0kΩ	(55.9)kΩ		
1.95			99.5kΩ	(99.5)kΩ		
2.0			62.2kΩ	(187.0)kΩ		
2.05			39.7kΩ	(448.0)kΩ		
2.1			24.8kΩ		(3.0)kΩ	
2.15			14.1kΩ	473.0kΩ	(14.1)kΩ	
2.2			6.1kΩ	212.0kΩ	(29.0)kΩ	
2.25				124.0kΩ	(49.7)kΩ	
2.3				80.8kΩ	(80.8)kΩ	
2.35				54.7kΩ	(133.0)kΩ	
2.4				37.3kΩ	(236.0)kΩ	
2.45				24.8kΩ	(548.0)kΩ	
2.5				15.5kΩ		
2.55				8.2kΩ	573.0kΩ	
2.6				2.4kΩ	261.0kΩ	
2.65					158.0kΩ	
2.7					106.0kΩ	
2.75					74.6kΩ	
2.8					53.9kΩ	(7.4)kΩ
2.85					39.0kΩ	(16.5)kΩ
2.9					27.9kΩ	(27.9)kΩ
2.95					19.3kΩ	(42.6)kΩ
3.0					12.4kΩ	(62.2)kΩ
3.1					2.0kΩ	(131.0)kΩ
3.2						(336.0)kΩ
3.3						
3.4						361.0kΩ
3.5						156.0kΩ
3.6						87.0kΩ
3.7						52.8kΩ
3.8						32.3kΩ

R1 = Black R2 = (Blue)

PACKAGING INFORMATION

Orderable Device	Status (1)	Package Type	Package Drawing	Pins	Package Qty	Eco Plan (2)	Lead/Ball Finish	MSL Peak Temp (3)	Samples (Requires Login)
PT6424E	LIFEBUY	SIP MODULE	EDC	14	12	Pb-Free (RoHS)	Call TI	Level-1-215C-UNLIM	
PT6425D	OBSOLETE	SIP MODULE	EDA	14		TBD	Call TI	Call TI	
PT6425E	LIFEBUY	SIP MODULE	EDC	14	12	Pb-Free (RoHS)	Call TI	Level-1-215C-UNLIM	
PT6429P	LIFEBUY	SIP MODULE	EDD	14	12	Pb-Free (RoHS)	Call TI	N / A for Pkg Type	

(1) The marketing status values are defined as follows:

ACTIVE: Product device recommended for new designs.

LIFEBUY: TI has announced that the device will be discontinued, and a lifetime-buy period is in effect.

NRND: Not recommended for new designs. Device is in production to support existing customers, but TI does not recommend using this part in a new design.

PREVIEW: Device has been announced but is not in production. Samples may or may not be available.

OBSOLETE: TI has discontinued the production of the device.

(2) Eco Plan - The planned eco-friendly classification: Pb-Free (RoHS), Pb-Free (RoHS Exempt), or Green (RoHS & no Sb/Br) - please check <http://www.ti.com/productcontent> for the latest availability information and additional product content details.

TBD: The Pb-Free/Green conversion plan has not been defined.

Pb-Free (RoHS): TI's terms "Lead-Free" or "Pb-Free" mean semiconductor products that are compatible with the current RoHS requirements for all 6 substances, including the requirement that lead not exceed 0.1% by weight in homogeneous materials. Where designed to be soldered at high temperatures, TI Pb-Free products are suitable for use in specified lead-free processes.

Pb-Free (RoHS Exempt): This component has a RoHS exemption for either 1) lead-based flip-chip solder bumps used between the die and package, or 2) lead-based die adhesive used between the die and leadframe. The component is otherwise considered Pb-Free (RoHS compatible) as defined above.

Green (RoHS & no Sb/Br): TI defines "Green" to mean Pb-Free (RoHS compatible), and free of Bromine (Br) and Antimony (Sb) based flame retardants (Br or Sb do not exceed 0.1% by weight in homogeneous material)

(3) MSL, Peak Temp. -- The Moisture Sensitivity Level rating according to the JEDEC industry standard classifications, and peak solder temperature.

Important Information and Disclaimer: The information provided on this page represents TI's knowledge and belief as of the date that it is provided. TI bases its knowledge and belief on information provided by third parties, and makes no representation or warranty as to the accuracy of such information. Efforts are underway to better integrate information from third parties. TI has taken and continues to take reasonable steps to provide representative and accurate information but may not have conducted destructive testing or chemical analysis on incoming materials and chemicals. TI and TI suppliers consider certain information to be proprietary, and thus CAS numbers and other limited information may not be available for release.

In no event shall TI's liability arising out of such information exceed the total purchase price of the TI part(s) at issue in this document sold by TI to Customer on an annual basis.

IMPORTANT NOTICE

Texas Instruments Incorporated and its subsidiaries (TI) reserve the right to make corrections, enhancements, improvements and other changes to its semiconductor products and services per JESD46, latest issue, and to discontinue any product or service per JESD48, latest issue. Buyers should obtain the latest relevant information before placing orders and should verify that such information is current and complete. All semiconductor products (also referred to herein as "components") are sold subject to TI's terms and conditions of sale supplied at the time of order acknowledgment.

TI warrants performance of its components to the specifications applicable at the time of sale, in accordance with the warranty in TI's terms and conditions of sale of semiconductor products. Testing and other quality control techniques are used to the extent TI deems necessary to support this warranty. Except where mandated by applicable law, testing of all parameters of each component is not necessarily performed.

TI assumes no liability for applications assistance or the design of Buyers' products. Buyers are responsible for their products and applications using TI components. To minimize the risks associated with Buyers' products and applications, Buyers should provide adequate design and operating safeguards.

TI does not warrant or represent that any license, either express or implied, is granted under any patent right, copyright, mask work right, or other intellectual property right relating to any combination, machine, or process in which TI components or services are used. Information published by TI regarding third-party products or services does not constitute a license to use such products or services or a warranty or endorsement thereof. Use of such information may require a license from a third party under the patents or other intellectual property of the third party, or a license from TI under the patents or other intellectual property of TI.

Reproduction of significant portions of TI information in TI data books or data sheets is permissible only if reproduction is without alteration and is accompanied by all associated warranties, conditions, limitations, and notices. TI is not responsible or liable for such altered documentation. Information of third parties may be subject to additional restrictions.

Resale of TI components or services with statements different from or beyond the parameters stated by TI for that component or service voids all express and any implied warranties for the associated TI component or service and is an unfair and deceptive business practice. TI is not responsible or liable for any such statements.

Buyer acknowledges and agrees that it is solely responsible for compliance with all legal, regulatory and safety-related requirements concerning its products, and any use of TI components in its applications, notwithstanding any applications-related information or support that may be provided by TI. Buyer represents and agrees that it has all the necessary expertise to create and implement safeguards which anticipate dangerous consequences of failures, monitor failures and their consequences, lessen the likelihood of failures that might cause harm and take appropriate remedial actions. Buyer will fully indemnify TI and its representatives against any damages arising out of the use of any TI components in safety-critical applications.

In some cases, TI components may be promoted specifically to facilitate safety-related applications. With such components, TI's goal is to help enable customers to design and create their own end-product solutions that meet applicable functional safety standards and requirements. Nonetheless, such components are subject to these terms.

No TI components are authorized for use in FDA Class III (or similar life-critical medical equipment) unless authorized officers of the parties have executed a special agreement specifically governing such use.

Only those TI components which TI has specifically designated as military grade or "enhanced plastic" are designed and intended for use in military/aerospace applications or environments. Buyer acknowledges and agrees that any military or aerospace use of TI components which have **not** been so designated is solely at the Buyer's risk, and that Buyer is solely responsible for compliance with all legal and regulatory requirements in connection with such use.

TI has specifically designated certain components as meeting ISO/TS16949 requirements, mainly for automotive use. In any case of use of non-designated products, TI will not be responsible for any failure to meet ISO/TS16949.

Products

Audio	www.ti.com/audio
Amplifiers	amplifier.ti.com
Data Converters	dataconverter.ti.com
DLP® Products	www.dlp.com
DSP	dsp.ti.com
Clocks and Timers	www.ti.com/clocks
Interface	interface.ti.com
Logic	logic.ti.com
Power Mgmt	power.ti.com
Microcontrollers	microcontroller.ti.com
RFID	www.ti-rfid.com
OMAP Applications Processors	www.ti.com/omap
Wireless Connectivity	www.ti.com/wirelessconnectivity

Applications

Automotive and Transportation	www.ti.com/automotive
Communications and Telecom	www.ti.com/communications
Computers and Peripherals	www.ti.com/computers
Consumer Electronics	www.ti.com/consumer-apps
Energy and Lighting	www.ti.com/energy
Industrial	www.ti.com/industrial
Medical	www.ti.com/medical
Security	www.ti.com/security
Space, Avionics and Defense	www.ti.com/space-avionics-defense
Video and Imaging	www.ti.com/video

TI E2E Community

e2e.ti.com