

PA03 • P03A

FEATURES

- MO-127 COPPER POWER DIP™ PACKAGE
- HIGH INTERNAL POWER DISSIPATION — 500 watts
- HIGH VOLTAGE OPERATION — $\pm 75V$
- VERY HIGH CURRENT — ± 30 amps
- INTERNAL SOA PROTECTION
- OUTPUT SWINGS CLOSE TO SUPPLY RAILS
- EXTERNAL SHUTDOWN CONTROL



APPLICATIONS

- LINEAR AND ROTARY MOTOR DRIVES
- YOKE/MAGNETIC FIELD DEFLECTION
- PROGRAMMABLE POWER SUPPLIES to $\pm 68V$
- TRANSDUCER/AUDIO TO 1000W

DESCRIPTION

The super power PA03 advances the state of the art in both brute force power and self protection against abnormal operating conditions. Its features start with a copper dip package developed by Apex to extend power capabilities well beyond those attainable with the familiar TO-3 package. The increased pin count of the new package provides additional control features, while the superior thermal conductivity of copper allows substantially higher power ratings.

The PA03 incorporates innovative current limiting circuits limiting internal power dissipation to a curve approximating the safe operating area of the power transistors. The internal current limit of 35A is supplemented with thermal sensing which reduces the current limit as the substrate temperature rises. Furthermore, a subcircuit monitors actual junction temperatures and with a response time of less than ten milliseconds reduces the current limit further to keep the junction temperature at 175°C.

The PA03 also features a laser trimmed high performance FET input stage providing superior DC accuracies both initially and over the full temperature range.

TYPICAL APPLICATION

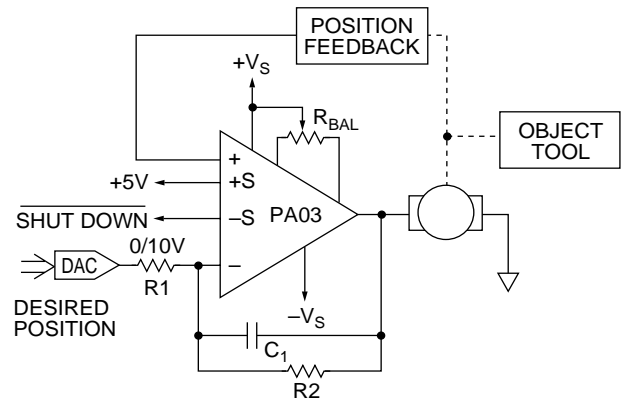

The PA03 output power stages contain fast reverse recovery diodes for sustained high energy flyback protection.

This hybrid integrated circuit utilizes thick film resistors, ceramic capacitors and silicon semiconductors to maximize reliability, minimize size and give top performance. Ultrasonically bonded aluminum wires provide reliable interconnections at all operating temperatures. The MO-127 Copper, 12-pin Power Dip™ package (see Package Outlines), is hermetically sealed and isolated from the internal circuits. Insulating washers are not recommended.

IMPORTANT: Observe mounting precautions.

EQUIVALENT SCHEMATIC

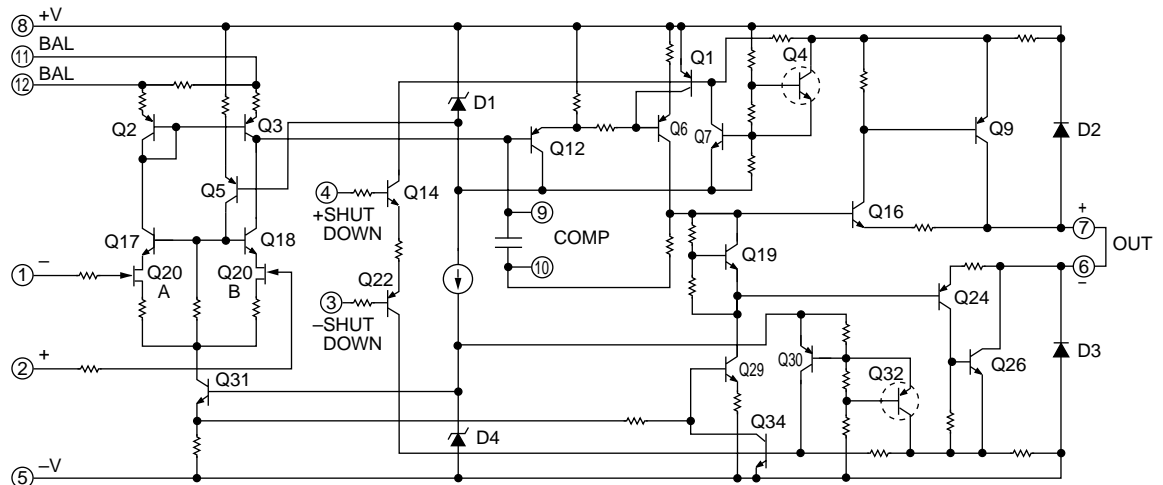

PA03 • PA03A

ABSOLUTE MAXIMUM RATINGS
SPECIFICATIONS

ABSOLUTE MAXIMUM RATINGS

SUPPLY VOLTAGE, $+V_S$ to $-V_S$	150V
OUTPUT CURRENT, within SOA	Internally limited
POWER DISSIPATION, internal	500W
INPUT VOLTAGE, differential	$\pm 25V$
INPUT VOLTAGE, common mode	$\pm V_S$
TEMPERATURE, pin solder-10s	300°C
TEMPERATURE, junction ¹	175°C
TEMPERATURE RANGE, storage	-65 to +150°C
OPERATING TEMP. RANGE, case	-55 to +125°C
SHUTDOWN VOLTAGE, differential	$\pm 5V$
SHUTDOWN VOLTAGE, common mode	$\pm V_S$

EXTERNAL CONNECTIONS

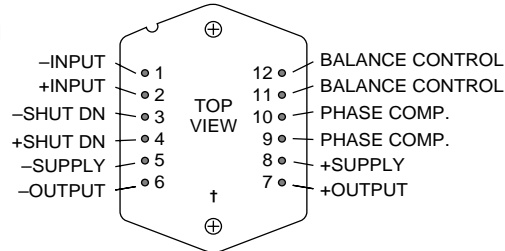

Pins 6 & 7 must be connected together.
If unused, tie Pins 11 & 12 to +SUPPLY.

† **IMPORTANT: OBSERVE MOUNTING PRECAUTIONS. REVERSE INSERTION WILL DESTROY UNIT.**

SPECIFICATIONS

PARAMETER	TEST CONDITIONS ²	PA03			PA03A			UNITS
		MIN	TYP	MAX	MIN	TYP	MAX	
INPUT								
OFFSET VOLTAGE, initial	$T_C = 25^\circ C$		$\pm .5$	± 2		$\pm .25$	$\pm .5$	mV
OFFSET VOLTAGE, vs. temperature	Full temperature range		10	30		5	10	$\mu V/^\circ C$
OFFSET VOLTAGE, vs. supply	$T_C = 25^\circ C$		8			*		$\mu V/V$
OFFSET VOLTAGE, vs. power	Full temperature range		20			10		$\mu V/W$
BIAS CURRENT, initial	$T_C = 25^\circ C$		5	50		3	10	pA
BIAS CURRENT, vs. supply	$T_C = 25^\circ C$.01			*		pA/V
OFFSET CURRENT, initial	$T_C = 25^\circ C$		2.5	50		1.5	10	pA
INPUT IMPEDANCE, DC	$T_C = 25^\circ C$		10 ¹¹			*		Ω
INPUT CAPACITANCE	$T_C = 25^\circ C$		6			*		pF
COMMON MODE VOLTAGE RANGE ³	Full temperature range	$\pm V_S - 10V$				*		V
COMMON MODE REJECTION, DC	Full temp. range, $V_{CM} = \pm 20V$	86	108			*		dB
SHUTDOWN CURRENT ⁴	Full temperature range		100			*		μA
SHUTDOWN VOLTAGE	Full temp. range, amp enabled			.85			*	V
SHUTDOWN VOLTAGE	Full temp. range, amp disabled	3.5				*		V
GAIN								
OPEN LOOP GAIN at 10Hz	Full temp. range, full load	92	102		*	*		dB
GAIN BANDWIDTH PRODUCT at 1MHz	$T_C = 25^\circ C$, full load		1			*		MHz
POWER BANDWIDTH	$T_C = 25^\circ C$, $I_O = 15A$, $V_O = 88V_{PP}$		30			*		kHz
PHASE MARGIN	Full temp. range, $C_C = 1.8nF$		65			*		°
OUTPUT								
VOLTAGE SWING ³	$T_C = 25^\circ C$, $I_O = 30A$	$\pm V_S - 7$	6.2		*	*		V
VOLTAGE SWING ³	Full temp. range, $I_O = 12A$	$\pm V_S - 5$	4.2		*	*		V
VOLTAGE SWING ³	Full temp. range, $I_O = 146mA$	$\pm V_S - 4$	3.5		*	*		V
CURRENT, peak	$T_C = 25^\circ C$	30			*	*		A
SETTLING TIME to .1%	$T_C = 25^\circ C$, 10V step		8			*		μs
SLEW RATE	$T_C = 25^\circ C$, C_C - open		8			*		V/ μs
CAPACITIVE LOAD	Full temp. range, $A_V = 1$	2			*	*		nF
SHUTDOWN DELAY	$T_C = -25^\circ C$, disable		10			*		μs
	$T_C = -25^\circ C$, operate		20			*		μs
POWER SUPPLY								
VOLTAGE	Full temperature range	± 15	± 50	± 75	*	*	*	V
CURRENT, quiescent ⁶	$T_C = 25^\circ C$		125	300		*	*	mA
CURRENT, disable mode	Full temperature range		25	40		*	*	mA
THERMAL								
RESISTANCE, AC junction to case ⁵	Full temp. range, $F > 60Hz$.22	.28		*	*	$^\circ C/W$
RESISTANCE, DC junction to case	Full temp. range, $F < 60Hz$.25	.3		*	*	$^\circ C/W$
RESISTANCE, junction to ambient	Full temperature range		14			*	*	$^\circ C/W$
TEMPERATURE, junction	Sustained operation			150		*	*	$^\circ C$
TEMPERATURE RANGE, case	Meets full range specification	- 25		85		*	*	$^\circ C$

- NOTES: * The specification of PA03A is identical to the specification for PA03 in applicable column to the left.
1. Long term operation at the maximum junction temperature will result in reduced product life. Derate power dissipation to achieve high MTTF.
 2. The power supply voltage for all specifications is the TYP rating unless noted as a test condition.
 3. $+V_S$ and $-V_S$ denote the positive and negative supply rail respectively. Total V_S is measured from $+V_S$ to $-V_S$.
 4. Rating applies if both shutdown inputs are least 1V inside supply rails. If one of the shutdown inputs is tied to a supply rail, the current in that pin may increase to 2.4mA.
 5. Rating applies if the output current alternates between both output transistors at a rate faster than 60Hz.
 6. The PA03 must be used with a heatsink or the quiescent power may drive the unit into thermal shutdown.

CAUTION

The internal substrate contains beryllia (BeO). Do not break the seal. If accidentally broken, do not crush, machine, or subject to temperatures in excess of 850°C to avoid generating toxic fumes.

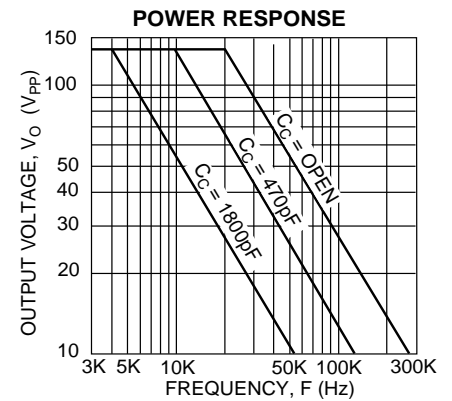
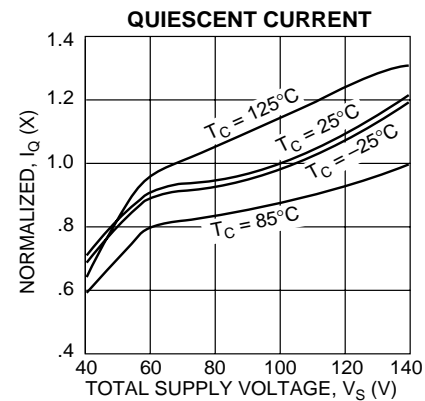
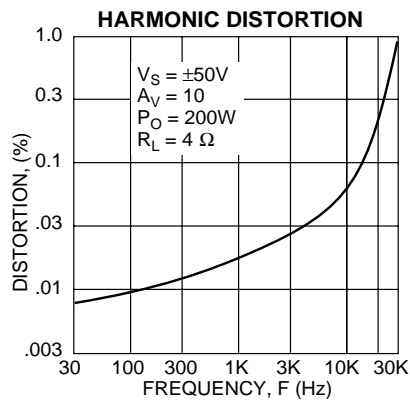
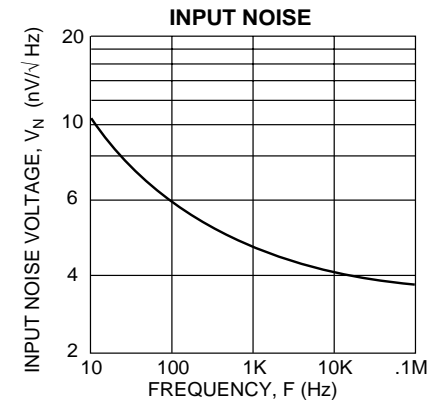
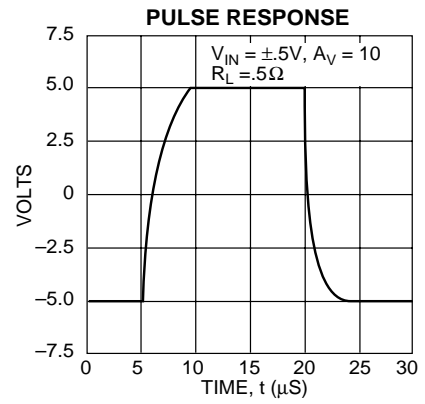
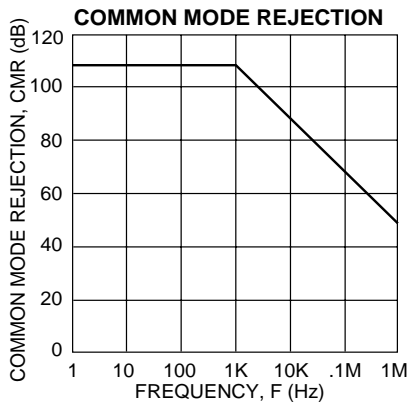
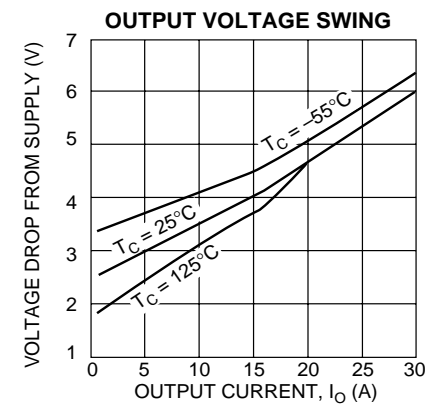
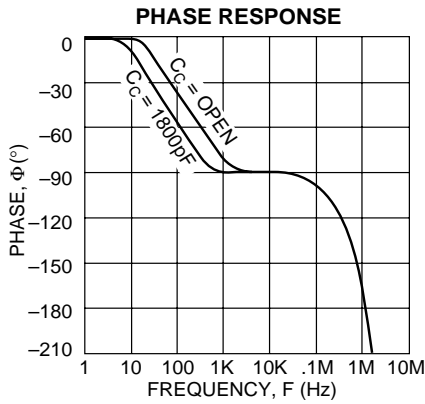
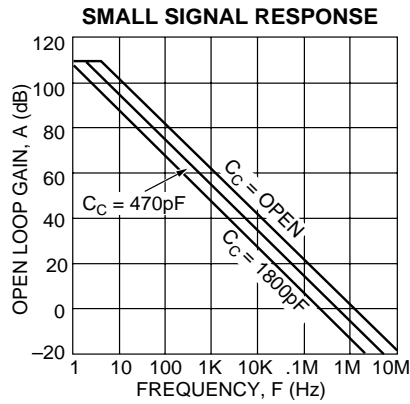
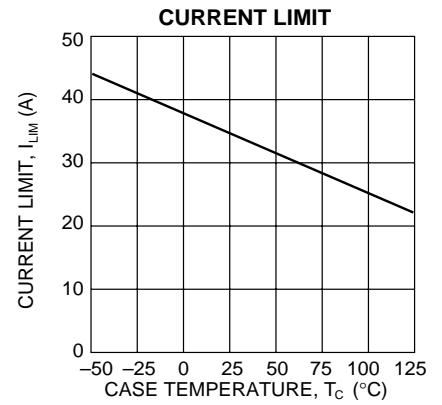
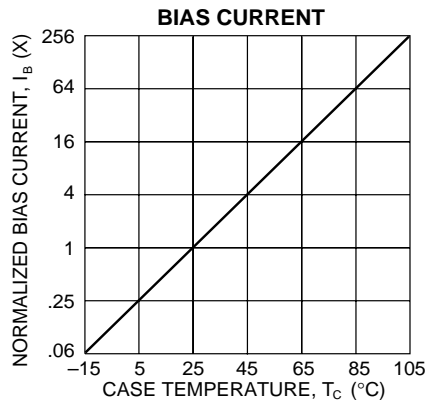
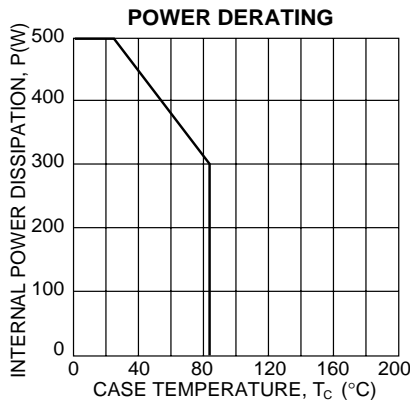

GENERAL

Please read the "General Operating Considerations" section, which covers stability, supplies, heatsinking, mounting, current limit, SOA interpretation, and specification interpretation. Additional information can be found in the application notes. For information on the package outline, heatsinks, and mounting hardware, consult the "Accessory and Package Mechanical Data" section of the handbook.

MOUNTING PRECAUTIONS

The PA03 copper base is very soft and easily bent. Do not put any stress on the mounting ears of this package. This calls for caution when pushing the amplifier into certain types of packaging foam and particularly when inserting the device into a socket. Insert the amplifier into the socket only by pushing on the perimeter of the package lid. Pushing the unit into the socket by applying pressure to the mounting tabs will bend the base due to the high insertion force required. The base will then not contact the heatsink evenly resulting in very poor heat transfer. To remove a unit from a socket, pry the socket away from the heatsink so that the heatsink will support the amplifier base evenly. Recommended mounting torque is 8–10 in.-lbs. (.9–1.13 N•m).

SAFE OPERATING AREA (SOA)

Due to the internal (non-adjustable) current limit of the PA03, worst case power dissipation calculations must assume current capability of 46 amps. Application specific circuits should be checked against the SOA curve when relying upon current limit for fault protection.

SAFE OPERATING AREA CURVES

Second breakdown limitations do apply to the PA03 but are less severe, since junction temperature limiting responds within 10ms. Stress levels shown as being safe for more than 10ms duration will merely cause thermal shutdown.

Under normal operating conditions, activation of the thermal shutdown is a sign that the internal junction temperatures have reached approximately 175°C. Thermal shutdown is a short term safety feature. If the conditions remain that cause thermal shutdown, the amplifier will oscillate in and out of shutdown, creating peak high power stresses, destroying useful signals, and reducing the reliability of the device.

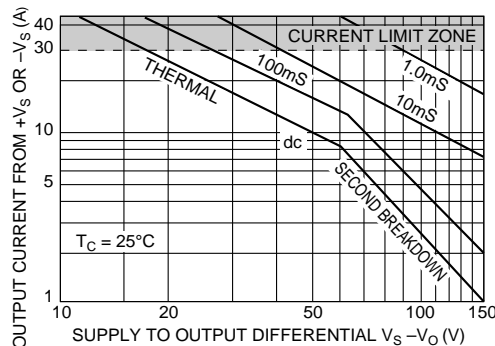

BALANCE CONTROL

The voltage offset of the PA03 may be externally adjusted to zero. To implement this adjustment install a 100 to 200 ohm potentiometer between pins 11 and 12 and connect the wiper arm to the positive supply. Bypass pins 11 and 12 each with at least a .01μF ceramic capacitor.

If the optional adjust provision is not used, connect both pins 11 and 12 to the positive supply.

OUTPUT STAGE SHUTDOWN

The entire power stage of the PA03 may be disabled using one of the circuits shown in Figure 1. There are many applications for this function. One is a load protection based on power delivered to the load or thermal rise. Another one is conservation of power when using batteries. The control voltage requirements accommodate a wide variety logic drivers.

1. CMOS operating at +5V can drive the control pins directly.
2. CMOS operating at greater than 5V supplies need a voltage divider.
3. TTL logic needs a pull up resistor to +5V to provide a swing to the fully disabled voltage (3.5V). When not using the shutdown feature, connect both pins 3 and 4 to common.

PHASE COMPENSATION

At low gain settings an external compensation capacitor is required to insure stability. In addition to the resistive feedback network, roll off or integrating capacitors must also be considered. A frequency of 1 MHz is most appropriate to calculate gain. Operation at gains below 10, without the external compensation capacitor opens the possibility of oscillations near output saturation regions when under load, the improper operation of the thermal shutdown circuit. This can result in amplifier destruction. At gains of 10 or more:

1. No external components are required.
2. Typical slew rate will be 8V/μs.
3. Typical phase margin will be 70°.

At a gain of 3:

1. Connect a 470pF compensation capacitor between pins 9 and 10.
2. Typical slew rate will be 5V/μs.
3. Typical phase margin will be 45°.

At unity gain:

1. Connect a 1.8nF compensation capacitor between pins 9 and 10.
2. Typical slew rate will be 1.8V/μs.
3. Typical phase margin will be 65°.

FIGURE 1a. DIRECT DRIVE OF SHUTDOWN

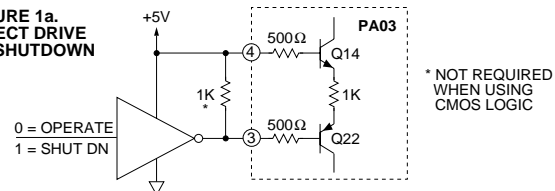

FIGURE 1b. HIGH VOLTAGE LOGIC INTERFACE

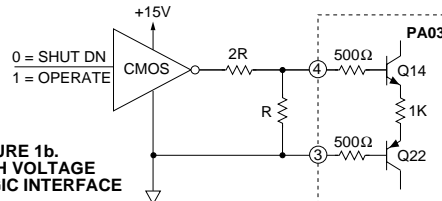

FIGURE 1c. THERMALLY ACTIVATED SHUTDOWN

