

PCM REMOTE CONTROL TRANSMITTERS

- M 709 : 40 COMMANDS x 16 ADDRESSES
- M 710 : 64 COMMANDS x 16 ADDRESSES
- ADDRESS ORGANIZATION PROVIDES WIDE RANGE OF SIMULTANEOUS APPLICATIONS WITHOUT INTERFERENCE BETWEEN SYSTEMS
- IMPROVED PCM TRANSMISSION CODE PROVIDES EASY RECOGNITION OF FALSE SIGNALS
- "FLASH" OR "CARRIER" PIN SELECTABLE TRANSMISSION MODES
- END OF TRANSMISSION CODE
- SINGLE CONTACT MATRIX KEYBOARD
- INTEGRATED ANTIBOUNCE AND INTERLOCK
- WIDE SUPPLY RANGE (M709/M710 4.5 to 10.5 V) / (M709A 3 to 10.5 V)
- WIDE REFERENCE FREQUENCY RANGE (445 to 510 kHz ceramic resonator)
- VERY LOW POWER CONSUMPTION DURING TRANSMISSION. OUTPUT DUTY CYCLE 0.15 % (flash mode), 0.7 % (carrier mode)
- TO BE USED IN CONJUNCTION WITH M104 OR M105 R.C. RECEIVERS (flash mode). THE CARRIER MODE IS FOR π P DECODING (e.g. PLL frequency synthesizer with M3870/M3872 and M206)

The reference oscillator is controlled by a cheap ceramic or LC resonator and when the M709/M710 work in conjunction with the M104 or M105 R.C. receives the oscillator frequency can be in the range 445 to 510 kHz and no synchronization is required with the receiver clock. Two types of transmission mode are available : "Flash" or "Carrier" mode.

The M709 is a simplified version of the M710 which can only transmit 40 commands with 16 possible addresses. The M710 on the other hand has the full system capacity : it can transmit 64 commands with 16 addresses.

The M709 and M710 are produced with CMOS Si-gate technology and are available in 24 and 28-pin dual in-line plastic packages respectively.

DESCRIPTION

These ICs have been developed for remote control in consumer applications (TV, radio, videorecorders) or in the industrial field and use a highly reliable transmission code which has a capacity of 1024 channels. Each transmitted word is structured into 4 bits which constitute the address and 6 bits which constitute the command (64 commands available). One command (1 st = 000000) is used to transmit the "end of transmission code" when the key is released. Additional bits are transmitted for synchronization of transmitter and receiver clocks and for security checks. The address organization provides a wide range of simultaneous applications without interference between systems. The receiver accents the decoded command only if the transmitted address matches the address selected at the receiver. 16 addresses are available for this purpose.

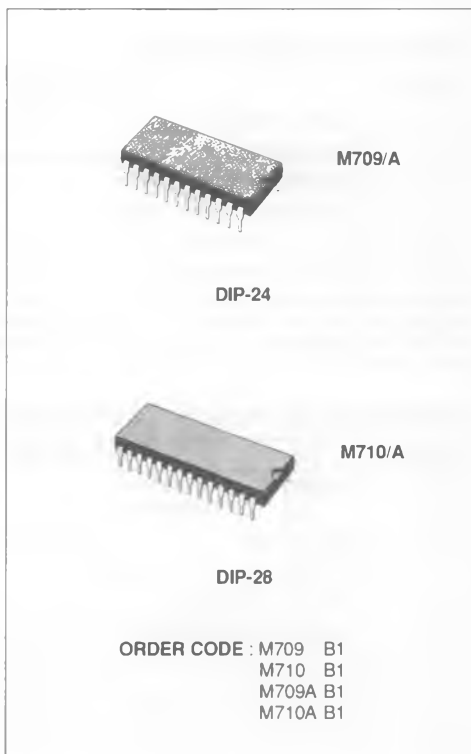

PIN CONNECTIONS

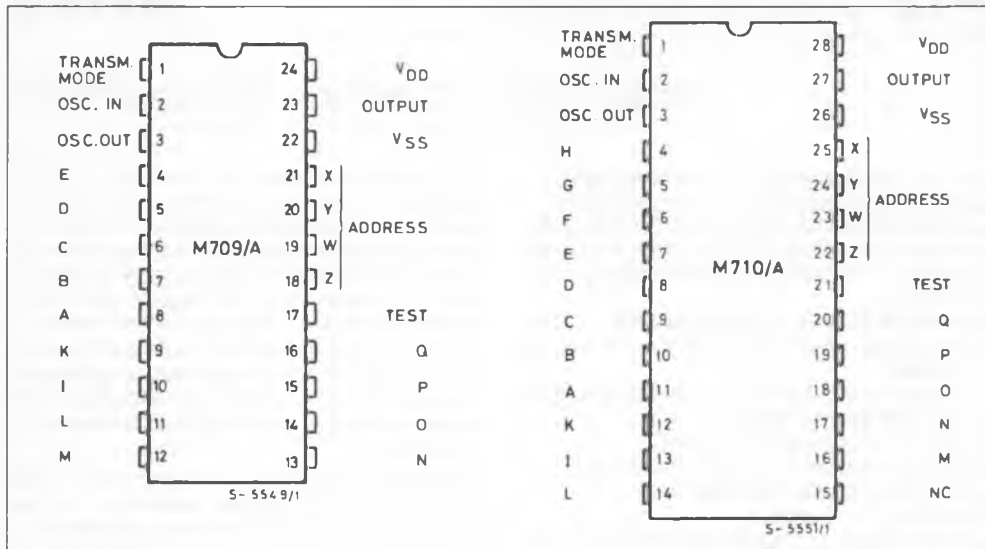

Note : The test pin must be connected to V_{SS}.

ABSOLUTE MAXIMUM RATINGS

Symbol	Parameter	Value	Unit
V _{DD}	Supply Voltage	- 0.3 to 12	V
V _I	Input Voltage	- 0.3 to V _{DD} + 0.3	V
I _O	IR Output Current (t < 50 μs)	10	mA
P _{Tot}	Total Package Power Dissipation	200	mW
T _{op}	Operating Temperature	0 to 70	°C
T _{stg}	Storage Temperature	- 55 to + 125	°C

Stresses above those listed under "Absolute Maximum Ratings" may cause permanent damage to the device. This is a stress rating only and functional operation of the device at these or any other conditions above those indicated in the operational sections of this specification is not implied. Exposure to absolute maximum rating conditions for extended periods may affect device reliability.

RECOMMENDED OPERATING CONDITIONS

Symbol	Parameter	Value	Unit
V _{DD}	Supply Voltage : M709/M710 M709A/M710A	4.5 to 10.5	V
		3 to 10.5	V
V _I	Input Voltage	0 to V _{DD}	
I _O	IR Output Current (t < 50 μs)	max. 2.5	mA
f _{ref}	Reference Frequency	445 to 510	kHz
T _{op}	Operating Temperature	0 to 70	°C
r _s	Serial Resistance of a Closed Key Contact	max. 2.5	KΩ
r _p	Parallel Resistance of Open Key Contact	min. 2.2	MΩ
R _s	Serial Resistance of the Ceramic Resonator	max. 20	Ω

FUNCTIONAL DESCRIPTION

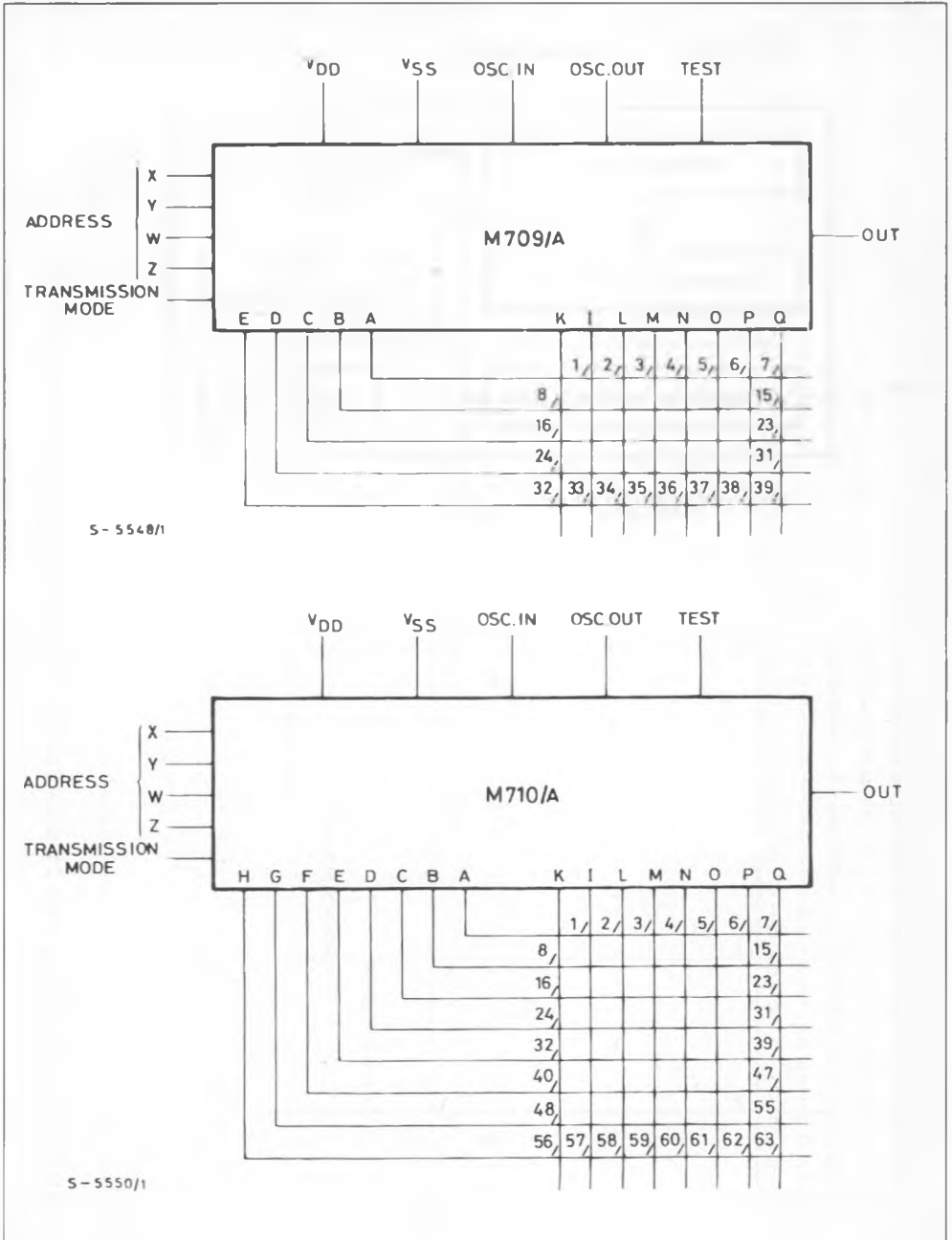

BLOCK DIAGRAM

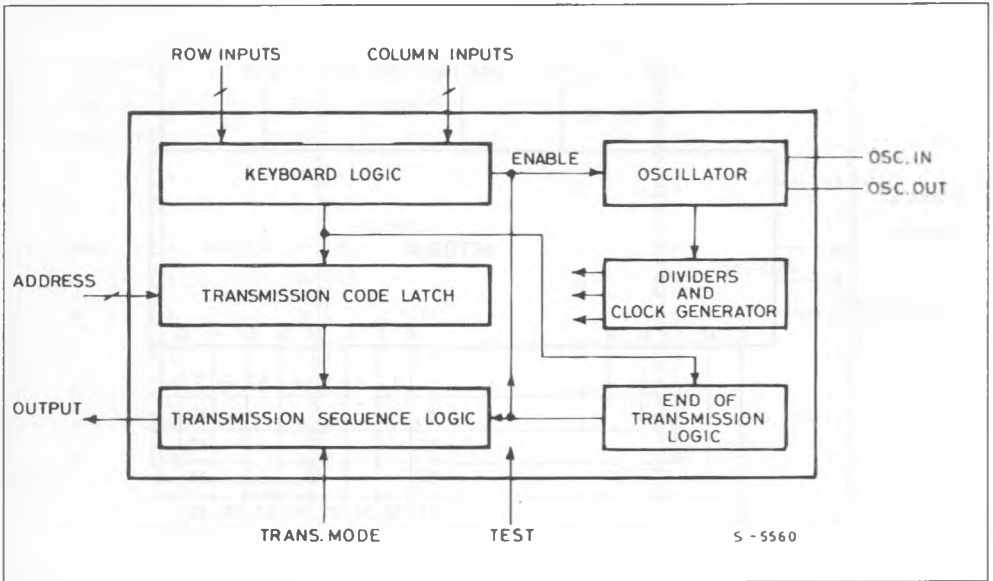

TRUTH TABLE

Command N°	Input Code											Command Bits												
	A	B	C	D	E	F	G	H	K	I	L	M	N	O	P	Q	C1	C2	C3	C4	C5	C6		
0	End of Transmission											0	0	0	0	0	0	0	0	0	0	0	0	0
1	X								X								1	0	0	0	0	0	0	
2	X									X							0	1	0	0	0	0	0	
3	X										X						1	1	0	0	0	0	0	
4	X											X					0	0	1	0	0	0	0	
5	X												X				1	0	1	0	0	0	0	
6	X													X			0	1	1	0	0	0	0	
7	X														X		1	1	1	0	0	0	0	
8		X							X								0	0	0	1	0	0	0	
9		X								X							1	0	0	1	0	0	0	
10		X									X						0	1	0	1	0	0	0	
11		X										X					1	1	0	1	0	0	0	
12		X											X				0	0	1	1	0	0	0	
13		X												X			1	0	1	1	0	0	0	
14		X													X		0	1	1	1	0	0	0	
15		X														X	1	1	1	1	0	0	0	
16			X						X								0	0	0	0	1	0	0	
17			X							X							1	0	0	0	1	0	0	
18			X								X						0	1	0	0	0	1	0	
19			X									X					1	1	0	0	0	1	0	
20			X										X				0	0	1	0	1	0	0	
21			X											X			1	0	1	0	1	0	0	
22			X												X		0	1	1	0	1	0	0	
23			X													X	1	1	1	0	1	0	0	
24				X					X								0	0	0	1	1	0	0	
25				X						X							1	0	0	1	1	0	0	
26				X							X						0	1	0	1	1	0	0	
27				X								X					1	1	0	1	1	0	0	
28				X									X				0	0	1	1	1	0	0	
29				X										X			1	0	1	1	1	0	0	
30				X											X		0	1	1	1	1	0	0	
31				X												X	1	1	1	1	1	0	0	
32					X				X								0	0	0	0	0	0	1	
33					X					X							1	0	0	0	0	0	1	
34					X						X						0	1	0	0	0	0	1	
35					X							X					1	1	0	0	0	0	1	
36					X								X				0	0	1	0	0	0	1	
37					X									X			1	0	1	0	0	0	1	
38					X										X		0	1	1	0	0	0	1	
39					X											X	1	1	1	0	0	0	1	
40						X			X								0	0	0	1	0	0	1	
41						X				X							1	0	0	1	0	0	1	
42						X					X						0	1	0	1	0	0	1	
43						X						X					1	1	0	1	0	0	1	
44						X							X				0	0	1	1	0	0	1	
45						X								X			1	0	1	1	0	0	1	
46						X									X		0	1	1	1	0	0	1	
47						X										X	1	1	1	1	0	0	1	
48							X		X								0	0	0	0	1	1	1	
49							X			X							1	0	0	0	1	1	1	
50							X				X						0	1	0	0	0	1	1	
51							X					X					1	1	0	0	0	1	1	
52							X						X				0	0	1	0	1	1	1	
53							X							X			1	0	1	0	1	1	1	
54							X								X		0	1	1	0	1	1	1	
55							X									X	1	1	1	0	1	1	1	
56								X	X								0	0	0	1	1	1	1	
57								X		X							1	0	0	1	1	1	1	
58								X			X						0	1	0	1	1	1	1	
59								X				X					1	1	0	1	1	1	1	
60								X					X				0	0	1	1	1	1	1	
61								X						X			1	0	1	1	1	1	1	
62								X							X		0	1	1	1	1	1	1	
63								X								X	1	1	1	1	1	1	1	

STATIC ELECTRICAL CHARACTERISTICS (over recommended operating conditions)

Typical values are at 9 V and $T_{amb} = 25\text{ }^{\circ}\text{C}$

Symbol	Parameter	Pins	Test Conditions		Value			Unit
					Min.	Typ.	Max.	
I_{DD}	Supply Voltage	M709 Pin 24 M710 Pin 28	$V_{DD} = 9\text{ V}$ IR Output Open	Stand-by		5	15	μA
				Operating (one key closed)		4	7	mA
I_{OH}	H State IR Output Current	M709 Pin 23 M710 Pin 27	$V_{DD} = 9\text{ V}$ $V_{OH} = 8\text{ V}$	-1.5	-2.5		mA	
			$V_{DD} = 4.5\text{ V}$ $V_{OH} = 3.5\text{ V}$	-0.3	-0.5			
I_{OL}	L State IR Output Current	M709 Pin 23 M710 Pin 27	$V_{DD} = 9\text{ V}$ $V_{OL} = 1\text{ V}$	1.5	-2.5		mA	
			$V_{DD} = 4.5\text{ V}$ $V_{OL} = 1\text{ V}$	0.3	0.5			
V_{TH}	Input Threshold High	Selection Inputs A to H	$V_{DD} = 9\text{ V}$			6	V	
			$V_{DD} = 4.5\text{ V}$			3		
V_{TL}	Input Threshold Low	Selection Inputs K to Q	$V_{DD} = 9\text{ V}$	3			V	
			$V_{DD} = 4.5\text{ V}$	1.5				
I_{IL}	Input Low Current	Pull-up Inputs A to H	$V_{DD} = 9\text{ V}$ $V_{IL} = 4.5\text{ V}$	-60		-300	μA	
I_{IH}	Input High Current	Pull-down Inputs K to Q	$V_{DD} = 9\text{ V}$ $V_{IH} = 4.5\text{ V}$	60		300	μA	
I_{IH}	Input High Current	Address Selection Inputs	$V_{DD} = 9\text{ V}$ $V_{IL} = 8.25\text{ V}$ (oscillator running)			150	μA	
I_L	Input Leakage Current	Trans. Mode Test Pin	$V_{DD} = 9\text{ V}$ $V_{IN} = 0\text{ to }9\text{ V}$			1	μA	
I_{OS}	Output Current	Osc. Out.	$V_{DD} = 9\text{ V}$ Osc. In. = V_{SS}	-2		-8	μA	

DESCRIPTION

The signals are transmitted with infrared light using pulse code modulation. Each word consists of 12 bits. The binary information of a bit is determined by the time interval between two pulses.

If "T" is the time base, the bits are coded as follows :

Odd bits (1, 3, etc)

0 = T

1 = 2T

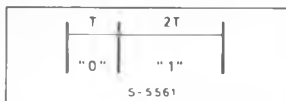

Even bits (2, 4, etc)

0 = T

1 = 3T

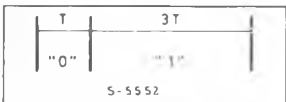

The different code introduced for the even and odd "1s" improves the capability to recognize false codes at the receiver end. For example the double error which can cause the exchange "10" with "01" is easily detected.

A parity bit is also added in order to further increase the reliability of the transmission. This bit is "1" if the number of transmitted "1s" is even while it is "0" if the number of transmitted "1s" is odd.

In addition, every word contains a preliminary pulse, a start pulse and a stop pulse. The spacing between the preliminary and the start pulse is 4T. This is followed after 1T by 11 data pulses (one parity bit), and terminated after 4T interval by a stop pulse.

Consequently, a word in which the binary digit 0 occurs ten times has a total duration of 21T.

A word containing ten "1s" has a duration of 36T.

Example :

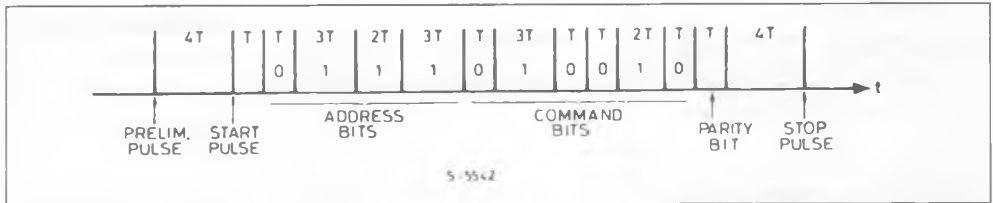

SYNCHRONIZATION BETWEEN TRANSMITTER AND RECEIVER

The transmitter and the receiver can operate with different reference frequencies.

Typical values suitable for correct operation of the system should be between 445 and 510 kHz, using a cheap ceramic resonator.

Synchronization between the transmitter and the receiver, necessary to obtain the wide range of frequency tolerance described above is achieved by measuring in the receiver the interval between the start pulse and the first data pulse, storing this value and using it as time base T.

KEYBOARD (pins A to Q) / CODE REPETITION

One column input (K to Q) has to be connected to one row (A to H) input to activate the transmitter.

The contact must be continuously closed for a minimum of 25 ms.

Double and multiple contact operations are not accepted.

The command information is repeatedly transmitted at intervals of 102 ms ($f_{ref} = 500$ kHz) as long as the push button remains operated.

When the contact is interrupted the circuit transmits, after a pause of about 18 ms, the "end of transmission code" and returns to stand-by mode.

If the contact is interrupted while a command is being transmitted the circuit carries on with the transmission to the end. After a pause of about 18 ms it transmits the end of transmission code.

No command is accepted until the "end of transmission code" is over.

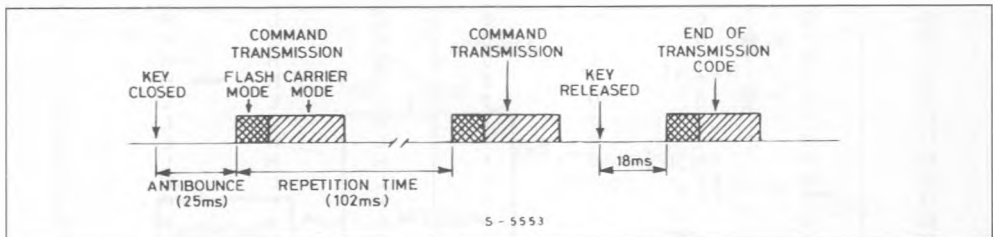

TRANSMISSION MODE (pin 7)

The M709/M710 can operate in Flash (pin T = V_{DD}) or Carrier (pin T = V_{SS}) transmission modes. Using

a reference frequency of 500 kHz the output signal has these formats :

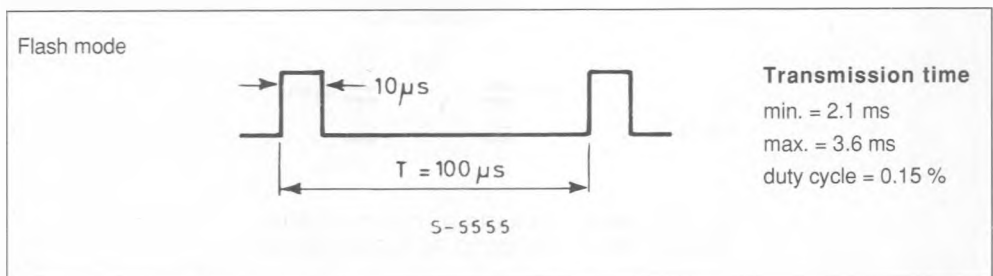

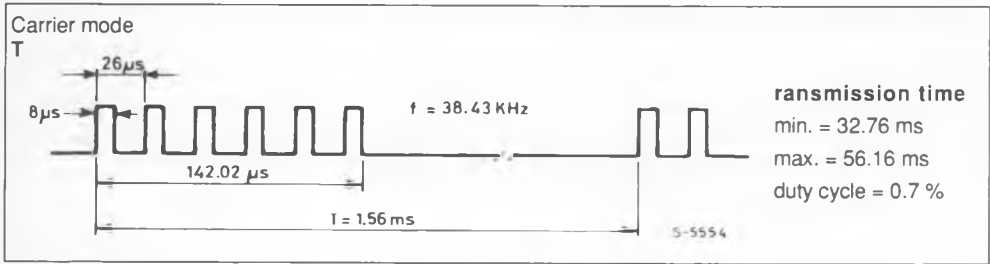

ADDRESS (pins X, Y, W, Z)

The Address information is coded and transmitted as follows :

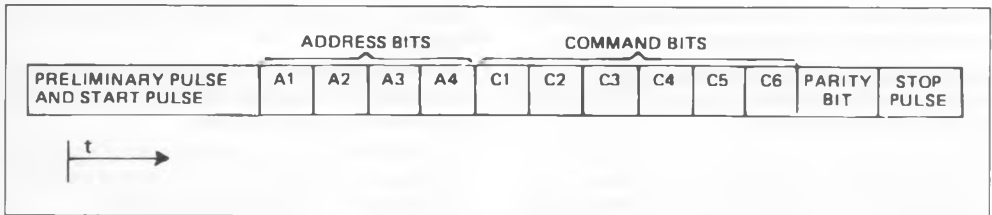

Address Number	Transmitted Code				Address Input Code			
	A1	A2	A3	A4	X	Y	W	Z
1	0	0	0	0	L	L	L	L
2	1	0	0	0	H	L	L	L
3	0	1	0	0	L	H	L	L
4	1	1	0	0	H	H	L	L
5	0	0	1	0	L	L	H	L
6	1	0	1	0	H	L	H	L
7	0	1	1	0	L	H	H	L
8	1	1	1	0	H	H	H	L
9	0	0	0	1	L	L	L	H
10	1	0	0	1	H	L	L	H
11	0	1	0	1	L	H	L	H
12	1	1	0	1	H	H	L	H
13	0	0	1	1	L	L	H	H
14	1	0	1	1	H	L	H	H
15	0	1	1	1	L	H	H	H
16	1	1	1	1	H	H	H	H

The address inputs have internal pull-downs which are disabled during stand-by

Single address selection

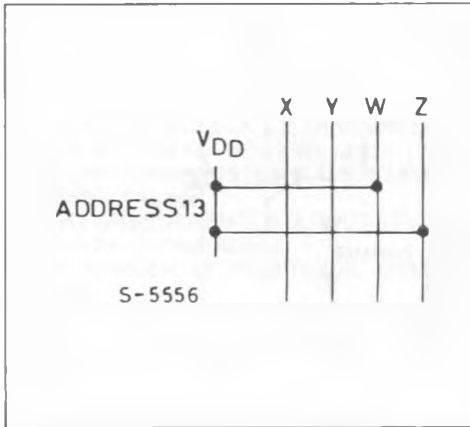

Multiple address selection

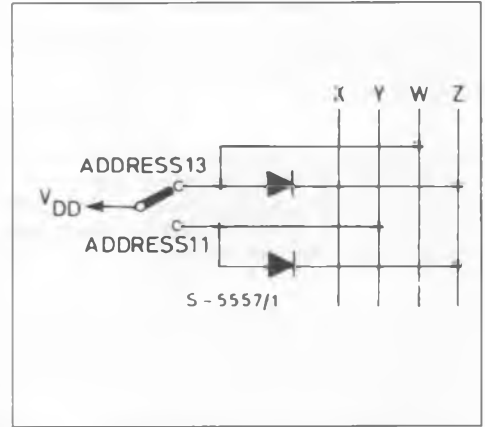

Note : unused inputs can be left open or connected to V_{SS}

TYPICAL APPLICATIONS

FLASH MODE

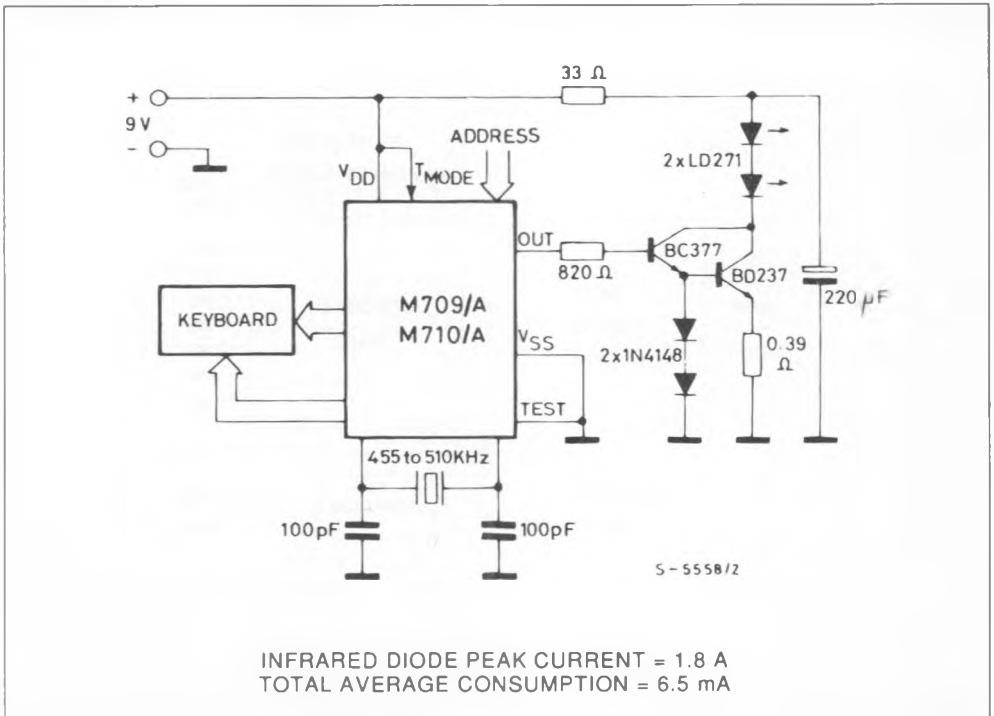

CARRIER MODE

