

EPM 16-ELECTRONIC PROGRAM MEMORY (16 STATIONS)

- ONE CHIP SOLUTION INCLUDING CONTROL AND NON VOLAT. MEMORY FOR 16 PROGR.
- 10 YEARS MEMORY RETENTION
- UNLIMITED NUMBERS OF READ CYCLES
- AUTOMATIC AND MANUAL STATION SEARCH
- EXTERNALLY ADJUSTABLE SEARCH SPEED
- FINE TUNING IN 8 STEPS, STORABLE FOR EACH PROGRAM SEPARATELY
- MUTE OUTPUT
- 4.43 MHz QUARTZ REFERENCE FREQUENCY

The M193 is a monolithic integrated circuit constructed in N-channel silicon gate technology, designed to control digitally via a D/A converter, with a resolution of 8192 steps, a TV or Radio varicap tuner. A 17 bit x 16 words NVRAM is also integrated in the chip. Each memory word contains information for 1 program, i.e. band (2 bit), tuning voltage (12 bit) and fine tuning offset (3 bit). The circuit is able to operate either in automatic or manual search. The search speed is externally controlled by a simple RC network. In the automatic mode the M193 works in conjunction with the TDA 4431, which provides TV station recognition and converts the AFC-S-curve into a digital command. This command controls the 13 bit up/down counter in the M193, whose position determines the tuning voltage. A mute output is provided to avoid noise on the audio during automatic search, program change or when the supply voltage is switched on/off. The circuit accepts standard program selection on 4 bus lines. 7-segment program display is possible using the M192 circuit connected at the same lines. A serial information output is provided to display on the screen, via the M191 integrated circuit, the varicap voltage in the form of a linear tuning bar and the band. The M193 is available in a 28 lead dual in-line plastic package. Three different types are available which differ as specified below.

M193A - The automatic search is implemented with two commands which provide to scan the bands I + UHF and III + S respectively.

M193C - The search, either automatic or manual, is done only in the selected band. The band can be changed with a separate step-by-step command.

M193D - Same search function characteristics of the C type. The only difference consists in the threshold of discrimination of pulses applied at pin 4 (fine tuning from remote control). This version interfaces with the "T" output of the SAA 1251 remote control receiver.

ABSOLUTE MAXIMUM RATINGS*

V_{DD1}, V_{DD2} **	Supply voltages	-0.3 to 20	V
V_{PP}	Memory supply voltage (pin 9)	-0.3 to 31	V
V_I	Input voltage	-0.3 to 20	V
$V_{O(off)}$	Off-state output voltage (except pin 14)	20	V
	(pin 14)	31	V
I_{OL}	Output current (except pins 15-19)	5	mA
	(pins 15-19)	15	mA
I_{OH}	Output current (pin 27)	-5	mA
P_{tot}	Total package power dissipation	1	W
T_{stg}	Storage temperature	-25 to 125	°C
T_{op}	Operating temperature	0 to 70	°C

* Stresses above those listed under "Absolute Maximum Ratings" may cause permanent damage to the device. This is a stress rating only and functional operation of the device at these or any other conditions above those indicated in the operational sections of this specification is not implied. Exposure to absolute maximum rating conditions for extended periods may affect device reliability.

** All voltages are with respect to V_{SS} (GND).

ORDERING NUMBERS: M193A B1
M193C B1
M193D B1

M 193A
M 193C
M 193D

MECHANICAL DATA (dimensions in mm)

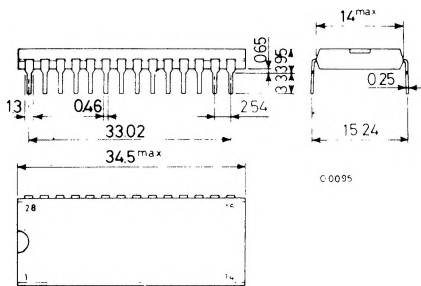

PIN CONNECTIONS

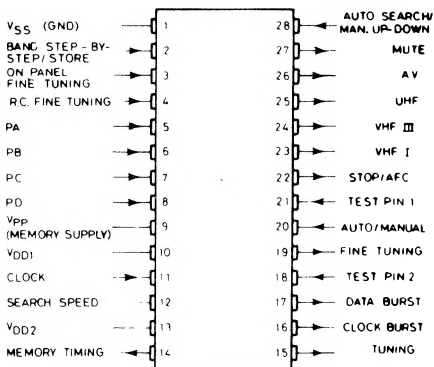

NOTE: TEST PINS must be connected to V_{SS} (GND)
 S-3215/1

RECOMMENDED OPERATING CONDITIONS

V _{DD1}	Supply voltage	17 to 19	V
V _{DD2}	Supply voltage	10.8 to 13.5	V
V _{PP}	Memory supply voltage (pin 9)	28 to 30	V
V _I	Input voltage	0 to 19	V
V _{O(off)}	Off-state output voltage (except pin 14)	max. 19	V
	Off-state output voltage (pin 14)	max. 30	V
I _{OL}	Output current (except 15-19)	max. 2.5	mA
	(pins 15-19)	max. 10	mA
I _{OH}	Output current (pin 27)	max. -2.5	mA
t _{pd}	Delay between memory timing and memory supply pulses	max. 5	μs
f	Clock frequency	4.4	MHz
R _s	Serial resistance of the quartz	max. 50	Ω
C _d	Dynamic capacitance of the quartz	max. 20	fF
C _p	Total parallel capacitance of the quartz	max. 8	pF
R _p	Total parallel resistance of the quartz	min. 10	MΩ
t _{w1}	Fine tuning + pulse width (pin 4)	> 1.8	ms
	M193D	> 120	μs
t _{w2}	Fine tuning - pulse width (pin 4)	< 1.7	ms
	M193A, C	< 80	μs
	M193D		
T _{op}	Operating temperature	0 to 70	°C
R ₁₂	Search speed resistance (pin 12)	18 to 330	KΩ
C ₁₂	Search speed capacitor (pin 12)	max. 100	nF

Notes: 1) The oscillator of the M193 cannot be used to drive external circuits.
 2) See the "General information" at the end of this data as far as the power-on supply sequence is concerned.

BLOCK DIAGRAM

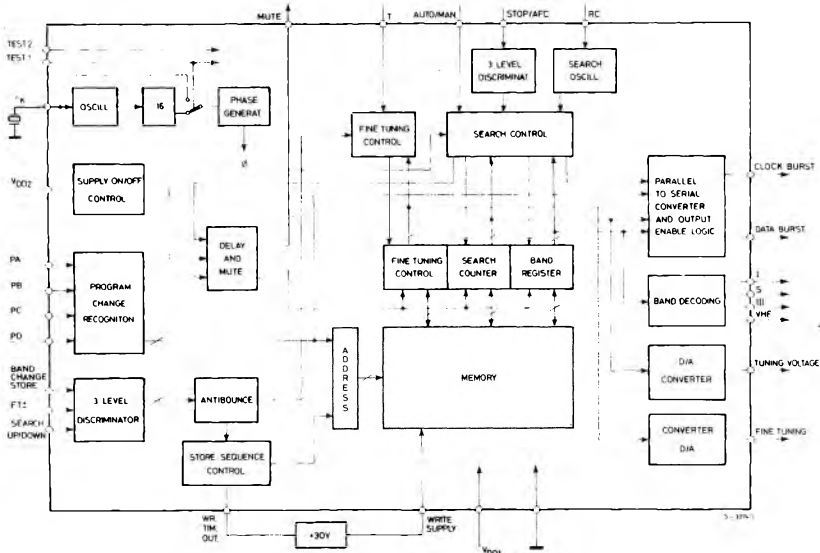

EPM SYSTEM CONFIGURATION

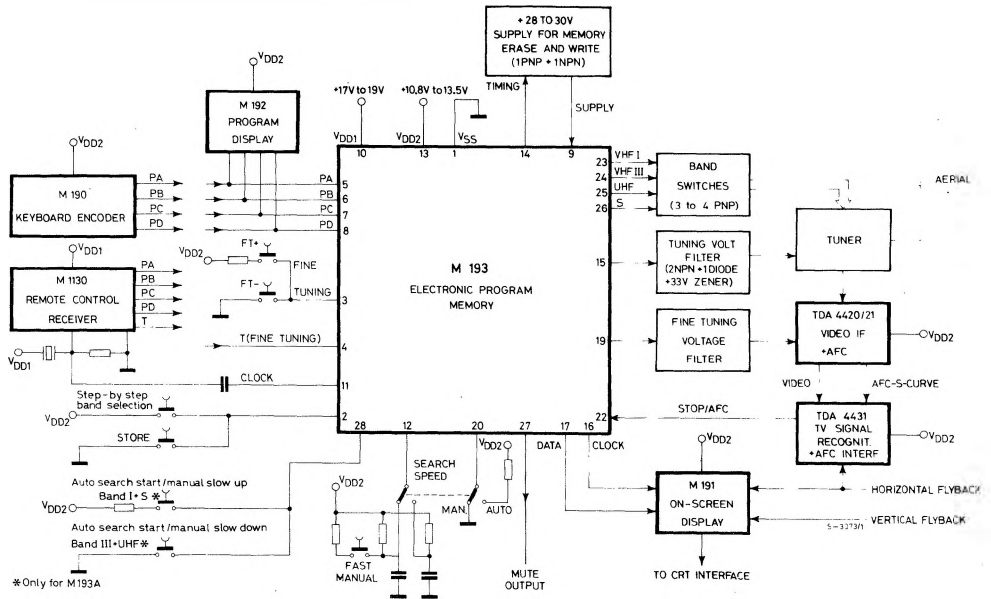



M 193A
M 193C
M 193D

STATIC ELECTRICAL CHARACTERISTICS (over recommended operating conditions)

Typical values are at $T_{amb} = 25^{\circ}\text{C}$, $V_{DD1} = 18\text{V}$, $V_{DD2} = 12\text{V}$ unless otherwise specified

Parameter	Pins	Test conditions	Values			Unit	
			Min.	Typ.	Max.		
V_{IL} Low level input voltage	4-5-6-7-8				0.8	V	
	2-3-20-22-28				1.3		
V_{IH} High level input voltage	4-5-6-7-8		3.5			V	
	2-3-28-20		V_{DD2}^{-2}				
	22		V_{DD2}^{-1}				
V_{IM} Middle level input voltage	22	$V_{DD2} = 10.8\text{V}$	4.5		7.5	V	
		$V_{DD2} = 13.5\text{V}$	5		9		
V_{OL} Low level output voltage	23-24-25-26	$V_{DD2} = 10.8\text{V}$ $I_{OL} = 1\text{mA}$			3	V	
	15-19	$V_{DD2} = 10.8\text{V}$ $I_{OL} = 10\text{mA}$			1		
	16-17	$V_{DD2} = 10.8\text{V}$ $I_{OL} = 1\text{mA}$			0.5		
	14	$V_{DD1} = 17\text{V}$ $V_{DD2} = 10.8\text{V}$ $I_{OL} = 2.5\text{mA}$			8		
V_{OH} High level output voltage	27	$V_{DD2} = 10.8\text{V}$ $I_{OH} = -1\text{mA}$	2.4			V	
$I_{O(off)}$ Output leakage current	27	$V_{DD2} = 13.5\text{V}$ $V_{O(off)} = V_{SS}$			-50	μA	
	23-24-25-26	$V_{DD2} = 13.5\text{V}$ $V_{O(off)} = 19\text{V}$			100		
	15-16-17-19	$V_{DD2} = 13.5\text{V}$ $V_{O(off)} = 13.5\text{V}$			50		
	14	$V_{DD1} = 19\text{V}$ $V_{O(off)} = 30\text{V}$ $V_{DD2} = 13.5\text{V}$			100		
I_I Input current	4-5-6-7-8-22	$V_I = 0$ to 19V			25	μA	
I_{DD1} Supply current	10	$V_{DD1} = 19\text{V}$			3	mA	
I_{DD2} Supply current	13	$V_{DD2} = 13.5\text{V}$		32	45	mA	
I_{PP} Memory supply current	9	$V_I = 30\text{V}$	write	peak		65	mA
				average		16	
			erase	peak		1	
				average		0.5	
R_I Input resistance	2-3-28	See Fig. 1a		0.5		$\text{M}\Omega$	

DYNAMIC ELECTRICAL CHARACTERISTICS ($f_{\text{clock}} = 4.43 \text{ MHz}$)

Parameter	Test conditions	Values			Unit
		Min.	Typ.	Max.	
f_o	Fine tuning output repetition rate		17305		Hz
D	Fine tuning output duty cycle	1/8		8/8	
t_{w3}	Width of erase pulses		115		μs
T_3	Period of erase pulses		231		μs
t_3	Total time for one erase cycle (about 500 pulses)		115		ms
t_{w4}	Width of write pulses		115		μs
T_4	Period of write pulses		462		μs
t_4	Total time for one write cycle (about 950 pulses)		440		ms
t_{w5}	Width of clock pulses		1.3		μs
T_5	Period of data and clock pulses		3.6		μs
t_5	Total time for one display burst (15 pulses)		54		μs
t_6	Burst repetition time		3.69		ms
t_7	Acceptance time of the commands	Pins 2-3-28	31		ms
t_8	Acceptance time of the commands	Pin 20	3.6		μs

Input and output configurations

All outputs (except the Mute one) have open drain configuration.

The Mute output has a source follower.

Inputs have the following configurations:

Fig. 1

a) Pins 2, 3, 28

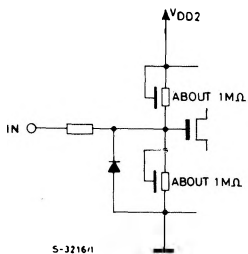

b) Search speed (pin 12)

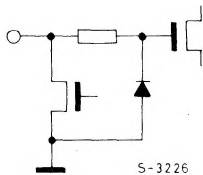

c) Clock input (pin 11)

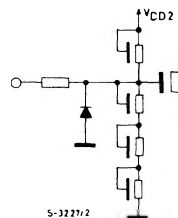

d) Other inputs (pin 4-5-6-7-8-12-20-21-22)

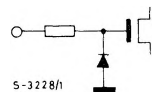

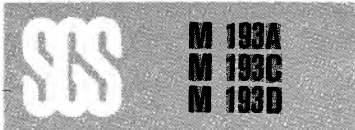

DESCRIPTION

The circuit description will be made following both pin sequence and pin function.

Pin 1 - V_{SS} (GND)

The substrate of the integrated circuit is connected to this pin. It is the reference point for all voltage parameters of the device and must be connected to the lowest potential of the supply voltage, normally ground.

Pin 2 - Store/sequential band change input

If this input pin is briefly connected to V_{SS} the 12 bits of the digitized tuning voltage, the 2 bits for band selection and the 3 bits of fine tuning information are stored.

The command is disabled during search and the execution of the store cycle.

The store cycle consists of two operations: at first the old word is cancelled and afterwards the new content is written.

If this input pin is briefly connected to V_{DD} , the selected band output changes in the sequence written below, to obtain a step-by-step band selection.

VHF III
 UHF
 VHF I
 S
 VHF III and so on

Pin 3 - Fine tuning +/- (on panel)

This input accepts the Fine tuning +/- commands given from the panel.

The commands are accepted according to the following rules:

Input levels	Command
M (input floating)	No command
H	FT +
L	FT -

Each command corresponds to one step change; to have more changes the key must be released and the command repeated.

Pin 4 - T input (fine tuning +/- from remote control)

The Fine tuning +/- commands given from Remote control are applied to this input in the form of a series of positive pulses. The threshold of discrimination of the pulses is different for the M193A, C and the M193D.

Type	t_{w1} (FT +)	t_{w2} (FT -)
M193A and C	> 1.8 ms	< 1.7 ms
M193D	> 120 μ s	< 80 μ s

The M193A and C are compatible with the M1130 remote control receiver.

The M193D interfaces with either the M1130 and the SAA 1251 receivers.

When the Fine tuning command is given, the duty cycle of the output of pin 19 (Fine tuning output) is changed at the rate of one step every 0.56 sec.

If the pulses are present for less than 0.56 sec. step-by-step operation can be obtained.

If this input is not used it must be connected to V_{SS} (GND).

Pins 5-6-7-8 - Program inputs

This 4-line bus selects the program according to the truth table given below:

Program	PA	PB	PC	PD
1	L	L	L	L
2	H	L	L	L
3	L	H	L	L
4	H	H	L	L
5	L	L	H	L
6	H	L	H	L
7	L	H	H	L
8	H	H	H	L
9	L	L	L	H
10	H	L	L	H
11	L	H	L	H
12	H	H	L	H
13	L	L	H	H
14	H	L	H	H
15	L	H	H	H
16	H	H	H	H

Pin 9 - V_{PP} - Memory supply

A series of pulses is applied to this pin during the store cycle. The timing of these pulses is given by the output of pin 14 and it is different during erase and write cycle as shown in fig. 2 and 3. During a store cycle the old word is at first cancelled and the new one is written afterwards.

Fig. 2 - Memory Erase supply

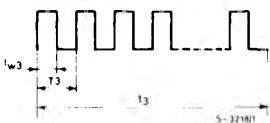
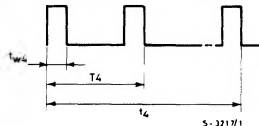

Fig. 3 - Memory Write supply



Pin 10 - V_{DD1}

This pin has to be connected to a power supply with the characteristics shown in the recommended operating conditions.

Pin 11 - Clock input

When the device is used alone the internal oscillator operates with a 4.43 MHz crystal connected between pin 11 and ground.

It can also operate with a single crystal together with M1130 as shown in fig. 4. It is not suggested to use the oscillator of the M193 to drive external circuits.

Fig. 4

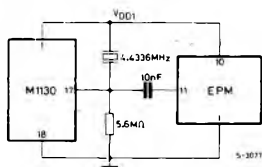



M 193A
M 193C
M 193D

Pin 12 - Search speed

An external RC network is connected to this pin in order to set the frequency of the internal oscillator which, in turn, sets the scan speed during Search mode.

The scan speed can be adjusted over a wide range.

The relationship of search speeds between UHF, VHF and S is as follows:

Automatic:

FAST UP VHF = the frequency externally fixed

FAST UP UHF = $S = 1/2$ FAST UP VHF

MEDIUM DOWN VHF = $1/4$ FAST UP VHF

MEDIUM DOWN UHF = $S = 1/4$ FAST UP UHF ($1/8$ FAST UP VHF)

SLOW UP VHF = UHF = $S = 67.7$ Hz

SLOW DOWN VHF = UHF = $S = 8.4$ Hz

Manual: UP or DOWN UHF = $S = 1/2$ UP or DOWN VHF

The manual Fast up or down speed is obtained by changing the frequency of the oscillator. The maximum capacitance which should be connected to this pin is 100 nF.

Pin 13 - V_{DD2}

This pin has to be connected to a power supply with the characteristics indicated in the recommended operating conditions.

Pin 14 - Memory write timing output

This output gives the timing for the pulses to be applied on pin 9 during the store cycle. The output consists of an open drain transistor.

The waveforms are shown in fig. 5 and 6, and are different during erase and write cycle, as already described for pin 9.

Fig. 5 - Memory Erase Current

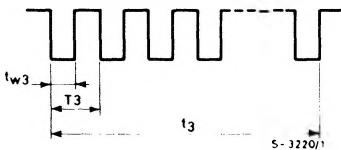
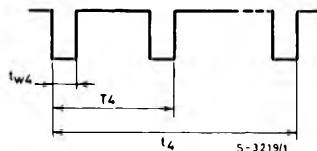

Fig. 6 - Memory Write Current



Pin 15 - Digitized tuning voltage output

The output consists of a variable frequency/variable width pulse train which, after filtering, provides the tuning voltage to the varicaps.

This signal carries 13 bits of information (only 12 bits however are stored in the memory).

The output circuit consists of an open drain transistor which offers a low impedance to ground when in the on state.

The output waveforms are shown in fig. 7.

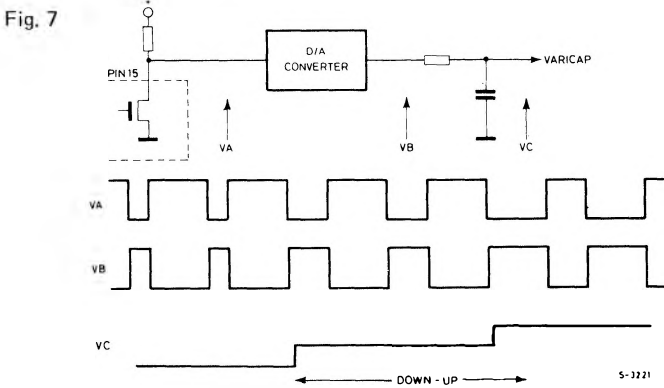

Pin 16 - Clock output for external display

A burst containing 15 clock pulses is available on this pin. These clock pulses are synchronized with Data Information as described in fig. 8.

Pin 17 - Data output for external display

A 15 bit burst is available on this pin.

It contains the 8 most significant bits of the digitized tuning voltage, 2 bits for band information, 4 bits for program information and 1 bit which indicates whether the system is in the Search mode (both in automatic and manual). This data is in complementary form (see fig. 8).

These two outputs (pins 16 and 17) work in connection with the M191 (On screen tuning bar display). When the burst is not transmitted, the output transistor is in the off position.

Fig. 8

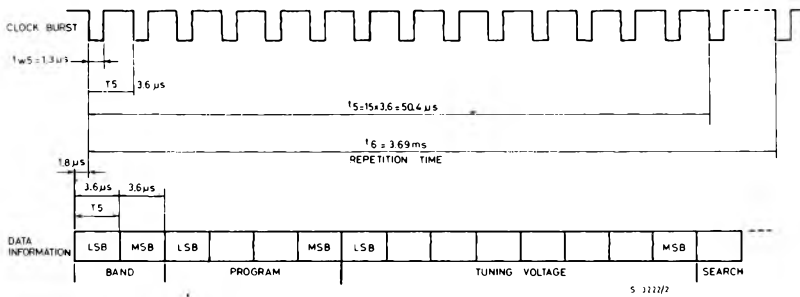

Pins 18 - 21 - Test pins

These pins must be connected to V_{SS} (GND).

Pin 19 - Fine tuning output

Fine tuning information is available on this pin in the form of a square wave having a frequency of 17305 Hz and duty cycle variable in 8 positions as indicated in fig. 9.

The voltage generated after filtering is fed to the AFC loop and detunes the receiver by a small Δf while maintaining the action of the AFC.

The Fine tuning function operates as follows:

- during the search the output is set at mid-range (see fig. 9).
- when the search has been completed it is possible to operate on the Fine tuning +/- commands (pin 3 for Remote control operation or pin 4 for panel operation). The Store command memorizes this information together with the 12 bit tuning voltage and 2 bit band information
- when a memorized program is recalled it is still possible to act on the Fine tuning commands.

Any change in Fine tuning is only memorized by the Store command.

Fig. 9

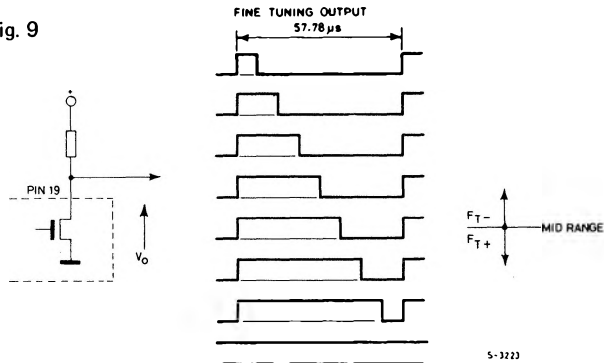

Pin 20 - Automatic/manual selection

This pin is used to change the Search mode. When it is connected to V_{DD} the system operates in Automatic mode; when it is at V_{SS} (GND) the system works manually. The change Auto-manual or viceversa can be made at every time without precluding the right operation of the system.

Pin 22 - Stop/afc input

This pin is used only in automatic search mode.

When the EPM is in manual operation this pin is internally disabled.

The Stop/afc is also internally disabled during any program change for the time the Mute signal lasts. This input can have three different levels: high (H), middle (M), low (L). The middle level, unlike the other three level inputs of the circuit, is not internally generated and has to be externally determined according to the recommended operating conditions. If this input is not used it has to be connected to V_{SS} (GND) or to V_{DD2} .

The input has two different functions depending on whether the system is in the search or in normal operation (AFC control).

A) **Search mode:** after depressing the Search start key, the transitions and levels of the signals coming from the TDA 4431, applied to this pin, control the search function and determine when the search must stop, i.e. a TV station has been recognized.

The circuit operates with the following sequence (see fig. 10 for reference and explanation of pin 12 for speed definition):

- 1 - after pressing the search start key the search occurs in the Fast up mode
- 2 - subsequent transitions on pin 22 Stop/afc input are ignored during the first 15 search steps. After that the first M-H transition on the input preceded by at least one M-L transition will set the search into the Medium down (fast up/4) mode. The acceptance delay of 15 search steps has been introduced to avoid the condition where the system could stop on the previous station (for example in the case the search start command has been given just before an AFC control command).
- 3 - the next M-L transition will switch the search to Slow up speed (67.7 Hz). At this point the system is in normal AFC operation.

Fig. 10 - Automatic station capture diagram

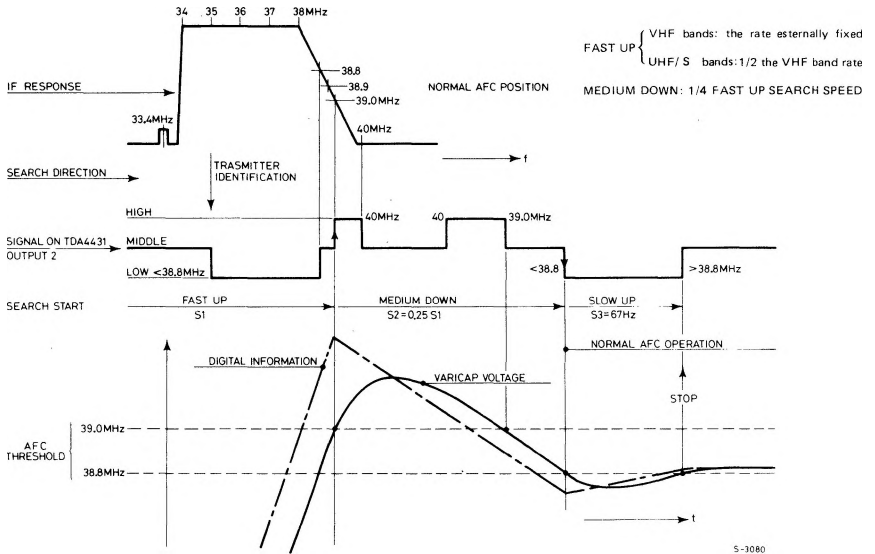

B) **AFC operation:** when a station is perfectly tuned, the input signal coming from TDA 4431 is at middle level.

If the tuning moves lower than the threshold (below 38.9 MHz), the pin 22 goes low and the 13 bit internal counter is moved with Slow up speed to determine an increasing of the varicap voltage. When a detuning occurs in the opposite direction the input will go high and the tuning voltage is decreased with Slow down speed (8.4 Hz).

The increase or decrease of the tuning voltage is stopped as soon as the input returns to M level. Therefore during normal operation pin 22 acts as AFC control command.

C) **Recall from memory:** when the circuit is in automatic operation mode and a pre-memorized program is recalled from Memory, a fixed value of 8 steps ($\cong 31.2$ mV) is subtracted from the tuning voltage. This corresponds to a detuning of about 0.6 MHz (UHF) and of 0.3 MHz in VHF III into that part of the IF response curve which corresponds to the fully transmitted sideband.

At this point the AFC operation takes over as described in point B) above and the exact tuning is reached in about 0.2 sec.

Due to this feature the AFC capture ratio will be increased and the requirements for stability of the tuner, of the reference voltage sources and of stability of the D/A converter are less severe.

In manual operation mode the memory content is instead read without any change.

Pins 23-24-25-26 - Band drive outputs

The information for band selection is present on these outputs, consisting of open drain transistors, one of which, in connection with the selected band, is conducting (see fig. 11).

The relations between pins and bands are as follows:

- Pin 23 = VHF I
- Pin 24 = VHF III
- Pin 25 = UHF
- Pin 26 = S

Fig. 11

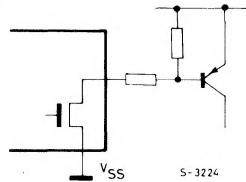

Pin 27 - Mute output

A source follower transistor is provided to give a high level output during mute function.

The mute is present in the following cases:

- during automatic search. The mute is present 110 msec before the start of the search.
- during any program change for 320 msec.
The mute is active 110 msec before the program change takes place.
- when the supply voltage V_{DD2} is applied, for about 320 msec.
- when the supply voltage V_{DD2} is removed.

**Pin 28 - A) Automatic operation: search start
B) Manual operation: up/down search**

This input is a three level one, i.e. it is normally in the middle level and the above mentioned functions are activated when it is connected to V_{DD2} or to GND.

The input is kept at a voltage corresponding to about the half of the supply voltage by an internal divider made with two resistors of about 1 Mohm.

A) Automatic operation

M193A - When the pin 28 is briefly connected to GND the search starts on the bands VHF III-UHF which are scanned in sequence. If it is connected to V_{DD2} the search is made on band VHF I and S. If the key is kept pushed, another search can start only by releasing the key and connecting it again to GND or V_{DD2} . If a Search start command is given while the system is already in search operation, the search is immediately stopped and after restarted on the new group of selected bands; the band where the system will search is that which has the same search speed of the previous one.

M193C, D-When the pin 28 is briefly connected to GND or to V_{DD2} , the search starts and remains in the previously selected band.

All types work as follows: if the key is kept pushed, another search can start only releasing the key and connecting it again to GND or V_{DD2} . During the search the tuning voltage is always changing from lower to higher voltage levels. The search is automatically stopped when the first station is found. The search is also stopped whenever a program change command is given. When the upper limit of the tuning voltage is reached, the search restarts from the lower limit of another band (M193A) or of the same band (M193C, D), after 210 msec of temporary stop. The search speed is determined by the RC network connected to pin 12.

B) Manual operation

When the input is connected to V_{DD2} the content of the internal counter is changed in such a way to have an increasing of the varicap voltage.

If the input is connected to GND the varicap voltage is decreased.

The search speed is determined by the RC network applied on pin 12.

Fast/low search speed is possible by changing the value of the same RC network (see fig. 12).

In manual operation the search is always made in the same band.

No inhibit of the search is provided when the lower or the upper limits of the varicap voltage are reached.

Step-by-step band selection is possible by temporarily connecting pin 2 to V_{DD2} .

Fig. 12

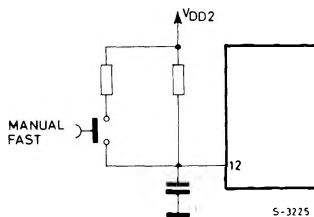

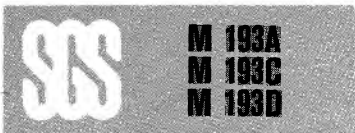

GENERAL INFORMATION

Command acceptance rules

- 1) When a manual command at pin 2, 3, 28 is given, an internal counter is immediately started. The command is accepted only after about 31 msec. of its continuous presence. If the command disappears before (for example in consequence of contact bouncing), the counter is immediately reset. When a command has been accepted, no other manual command is accepted until the previous command has been released.
- 2) Program change commands are immediately accepted and if the circuit is in the automatic search position, the search is stopped. Manual commands given during the execution of the program change are not accepted except the automatic search start command. This one is internally stored and executed at the end of the program change.
- 3) During the store cycle only the program change and the search start commands are accepted and executed at the end of the cycle. The other commands are ignored.

Power-on sequence of supply voltages

To guarantee the correct reading of the memory at power-on the supply voltages must be applied as follows:

$$V_{DD1} (+18V), V_{DD2} (+12V)$$

The +18V must be higher than 16.5V 110 msec after the 12V is passed through the power-on reset threshold ($\approx 6V$).

From 0 to 6V the slew rate of the 12V is not important, from 6 to 10V the slew rate must not exceed 110 ms. If it is not possible to guarantee the availability of the 18V supply before the 12V we suggest using the following application.

It is recommended that the 29V is not applied when the 12V is not present. However there are no reliability problems if at power on and power off the 29V exists for a few seconds without the 12V supply being present.

