

# FJH1101

## Ultra Low Leakage Diode

### General Description

An Ultra Low Leakage Diode in the DO-35 package.

The forward voltage is typically greater than 0.5 volts at 1.0 micro-ampere.

This product is light sensitive, any damage to the body coating will affect the reverse leakage when exposed to light.

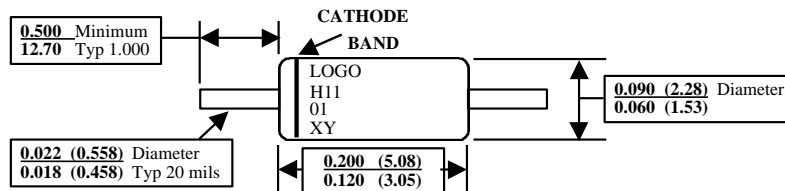

\* XY = 6 weeks marking date code, X = last digit of the calendar year (Alpha), Y = 6 weeks numeric code.

Typical Forward Voltages	
1.0 uA	530 mV
10 uA	605 mV
100 uA	685 mV
1.0 mA	780 mV
10 mA	895 mV
50 mA	995 mV
100 mA	1.07 V

### Absolute Maximum Ratings\* $T_A = 25^\circ\text{C}$ unless otherwise noted

Symbol	Parameter	Value	Units
$W_{IV}$	Working Inverse Voltage	15	V
$I_F$	DC Forward Current ( $I_F$ )	150	mA
$P_D$	Total Power Dissipation at $T_A = 25^\circ\text{C}$ Linear Derating Factor from $T_A = 25^\circ\text{C}$	250 1.67	mW mW/ $^\circ\text{C}$
$R_{\theta JA}$	Thermal Resistance Junction-to-Ambient	300	$^\circ\text{C}/\text{W}$
$T_J$	Operating Junction Temperature	175	$^\circ\text{C}$
$T_{STG}$	Storage Temperature	-55 to +200	$^\circ\text{C}$

\* These ratings are limiting values above which the serviceability of any semiconductor device may be impaired.

### Electrical Characteristics $T_A = 25^\circ\text{C}$ unless otherwise noted

Symbol	Parameter	Test Condition	Min.	Typ.	Max.	Units
$B_V$	Breakdown Voltage	$I_R = 5.0\mu\text{A}$	20			V
$I_R$	Reverse Leakage	$V_R = 5.0\text{V}$ $V_R = 15\text{V}$			5.0 15	pA pA
$V_F$	Forward Voltage	$I_F = 50\text{mA}$			1.1	V
$C_T$	Diode Capacitance	$V_R = 0\text{V}$ , $f = 1.0\text{MHz}$			2.0	pF

Physical Dimension

DO-35

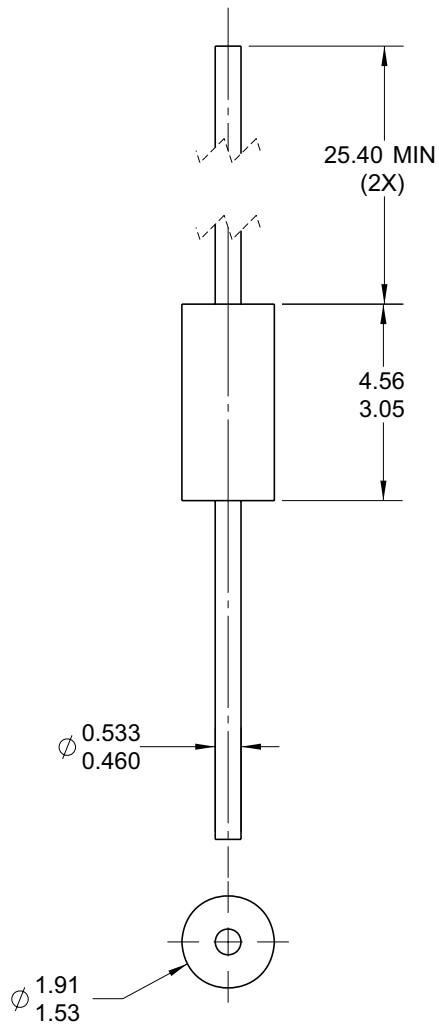

NOTES: UNLESS OTHERWISE SPECIFIED





- A) PACKAGE STANDARD REFERENCE:  
JEDEC DO-204, VARIATION AH.
- B) HERMETICALLY SEALED GLASS PACKAGE.
- C) PACKAGE WEIGHT IS 0.137 GRAM.
- D) ALL DIMENSIONS ARE IN MILLIMETERS.
- E) DRAWING FILE NAME: DO35AREV02

Dimensions in Millimeters



**TRADEMARKS**

The following includes registered and unregistered trademarks and service marks, owned by Fairchild Semiconductor and/or its global subsidiaries, and is not intended to be an exhaustive list of all such trademarks.

- |  |  |  |   |
|--|--|--|---|
| AccuPower™   | F-PFS™   | Power-SPM™   | The Power Franchise®  |
| Auto-SPM™  | FRFET®   | PowerTrench®   | The Right Technology for Your Success™  |
| AX-CAP™*   | Global Power Resource <sup>SM</sup>  | PowerXS™   | the <b>power</b> franchise  |
| Build it Now™  | Green FPS™   | Programmable Active Droop™   | TinyBoost™  |
| CorePLUS™  | Green FPS™ e-Series™   | QFET®  | TinyBuck™   |
| CorePOWER™   | Gmax™  | QS™  | TinyCalc™   |
| CROSSVOLT™   | GTO™   | Quiet Series™  | TinyLogic®  |
| CTL™   | IntelliMAX™  | RapidConfigure™  | TINYOPTO™   |
| Current Transfer Logic™  | ISOPLANAR™   |  ™                | TinyPower™  |
| DEUXPEED®  | MegaBuck™  | Saving our world, 1mW/W/kW at a time™  | TinyPWM™  |
| Dual Cool™   | MICROCOUPLER™  | SignalWise™  | TinyWire™   |
| EcoSPARK®  | MicroFET™  | SmartMax™  | TriFault Detect™  |
| EfficientMax™  | MicroPak™  | SMART START™   | TRUECURRENT®*   |
| ESBC™  | MicroPak2™   | SPM®   | μSerDes™  |
|  Fairchild® | MillerDrive™   | STEALTH™   |  SerDes™ |
| Fairchild Semiconductor®   | MotionMax™   | SuperFET®  | UHC®  |
| FACT Quiet Series™   | Motion-SPM™  | SuperSOT™-3  | Ultra FRFET™  |
| FACT®  | mWSaver™   | SuperSOT™-6  | UniFET™   |
| FAST®  | OptoHiT™   | SuperSOT™-8  | VCX™  |
| FastvCore™   | OPTOLOGIC®   | SupreMOS®  | VisualMax™  |
| FETBench™  | OPTOPLANAR®  | SyncFET™   | XS™   |
| FlashWriter®*  |  PDP SPM™ | Sync-Lock™   |   |
| FPS™   |  |  SYSTEM GENERAL®* |   |

\* Trademarks of System General Corporation, used under license by Fairchild Semiconductor.

**DISCLAIMER**

FAIRCHILD SEMICONDUCTOR RESERVES THE RIGHT TO MAKE CHANGES WITHOUT FURTHER NOTICE TO ANY PRODUCTS HEREIN TO IMPROVE RELIABILITY, FUNCTION, OR DESIGN. FAIRCHILD DOES NOT ASSUME ANY LIABILITY ARISING OUT OF THE APPLICATION OR USE OF ANY PRODUCT OR CIRCUIT DESCRIBED HEREIN; NEITHER DOES IT CONVEY ANY LICENSE UNDER ITS PATENT RIGHTS, NOR THE RIGHTS OF OTHERS. THESE SPECIFICATIONS DO NOT EXPAND THE TERMS OF FAIRCHILD'S WORLDWIDE TERMS AND CONDITIONS, SPECIFICALLY THE WARRANTY THEREIN, WHICH COVERS THESE PRODUCTS.

**LIFE SUPPORT POLICY**

FAIRCHILD'S PRODUCTS ARE NOT AUTHORIZED FOR USE AS CRITICAL COMPONENTS IN LIFE SUPPORT DEVICES OR SYSTEMS WITHOUT THE EXPRESS WRITTEN APPROVAL OF FAIRCHILD SEMICONDUCTOR CORPORATION.

As used herein:

1. Life support devices or systems are devices or systems which, (a) are intended for surgical implant into the body or (b) support or sustain life, and (c) whose failure to perform when properly used in accordance with instructions for use provided in the labeling, can be reasonably expected to result in a significant injury of the user.
2. A critical component in any component of a life support, device, or system whose failure to perform can be reasonably expected to cause the failure of the life support device or system, or to affect its safety or effectiveness.

**ANTI-COUNTERFEITING POLICY**

Fairchild Semiconductor Corporation's Anti-Counterfeiting Policy. Fairchild's Anti-Counterfeiting Policy is also stated on our external website, [www.fairchildsemi.com](http://www.fairchildsemi.com), under Sales Support.

Counterfeiting of semiconductor parts is a growing problem in the industry. All manufacturers of semiconductor products are experiencing counterfeiting of their parts. Customers who inadvertently purchase counterfeit parts experience many problems such as loss of brand reputation, substandard performance, failed applications, and increased cost of production and manufacturing delays. Fairchild is taking strong measures to protect ourselves and our customers from the proliferation of counterfeit parts. Fairchild strongly encourages customers to purchase Fairchild parts either directly from Fairchild or from Authorized Fairchild Distributors who are listed by country on our web page cited above. Products customers buy either from Fairchild directly or from Authorized Fairchild Distributors are genuine parts, have full traceability, meet Fairchild's quality standards for handling and storage and provide access to Fairchild's full range of up-to-date technical and product information. Fairchild and our Authorized Distributors will stand behind all warranties and will appropriately address any warranty issues that may arise. Fairchild will not provide any warranty coverage or other assistance for parts bought from Unauthorized Sources. Fairchild is committed to combat this global problem and encourage our customers to do their part in stopping this practice by buying direct or from authorized distributors.

**PRODUCT STATUS DEFINITIONS**

**Definition of Terms**

Datasheet Identification	Product Status	Definition
Advance Information	Formative / In Design	Datasheet contains the design specifications for product development. Specifications may change in any manner without notice.
Preliminary	First Production	Datasheet contains preliminary data; supplementary data will be published at a later date. Fairchild Semiconductor reserves the right to make changes at any time without notice to improve design.
No Identification Needed	Full Production	Datasheet contains final specifications. Fairchild Semiconductor reserves the right to make changes at any time without notice to improve the design.
Obsolete	Not In Production	Datasheet contains specifications on a product that is discontinued by Fairchild Semiconductor. The datasheet is for reference information only.