

# FDZ191P

## P-Channel 1.5V PowerTrench® WL-CSP MOSFET

-20V, -1A, 85mΩ

### Features

- Max  $r_{DS(on)}$  = 85mΩ at  $V_{GS} = -4.5V$ ,  $I_D = -1A$
- Max  $r_{DS(on)}$  = 123mΩ at  $V_{GS} = -2.5V$ ,  $I_D = -1A$
- Max  $r_{DS(on)}$  = 200mΩ at  $V_{GS} = -1.5V$ ,  $I_D = -1A$
- Occupies only 1.5 mm<sup>2</sup> of PCB area Less than 50% of the area of 2 x 2 BGA
- Ultra-thin package: less than 0.65 mm height when mounted to PCB
- RoHS Compliant

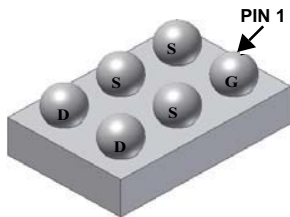


### General Description

Designed on Fairchild's advanced 1.5V PowerTrench process with state of the art "low pitch" WLCSP packaging process, the FDZ191P minimizes both PCB space and  $r_{DS(on)}$ . This advanced WLCSP MOSFET embodies a breakthrough in packaging technology which enables the device to combine excellent thermal transfer characteristics, ultra-low profile packaging, low gate charge, and low  $r_{DS(on)}$ .

### Application

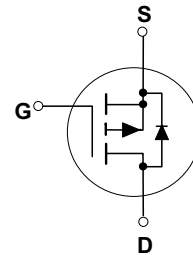
- Battery management
- Load switch
- Battery protection



BOTTOM



TOP



### MOSFET Maximum Ratings $T_A = 25^\circ\text{C}$ unless otherwise noted

Symbol	Parameter	Rated	Units
$V_{DS}$	Drain to Source Voltage	-20	V
$V_{GS}$	Gate to Source Voltage	±8	V
$I_D$	Drain Current -Continuous (Note 1a)	-3	A
	-Pulsed	-15	
$P_D$	Power Dissipation (Note 1a)	1.9	W
	Power Dissipation (Note 1b)	0.9	
$T_J, T_{STG}$	Operating and Storage Junction Temperature Range	-55 to +150	°C

### Thermal Characteristics

$R_{\theta JA}$	Thermal Resistance, Junction to Ambient (Note 1a)	65	°C/W
$R_{\theta JA}$	Thermal Resistance, Junction to Ambient (Note 1b)	133	

### Package Marking and Ordering Information

Device Marking	Device	Package	Reel Size	Tape Width	Quantity
1	FDZ191P	WL-CSP	7"	8mm	5000 units

### Electrical Characteristics $T_J = 25^\circ\text{C}$ unless otherwise noted

Symbol	Parameter	Test Conditions	Min	Typ	Max	Units
--------	-----------	-----------------	-----	-----	-----	-------

#### Off Characteristics

$BV_{DSS}$	Drain to Source Breakdown Voltage	$I_D = -250\mu\text{A}, V_{GS} = 0\text{V}$	-20			V
$\frac{\Delta BV_{DSS}}{\Delta T_J}$	Breakdown Voltage Temperature Coefficient	$I_D = -250\mu\text{A}$ , referenced to $25^\circ\text{C}$		-12		mV/ $^\circ\text{C}$
$I_{DSS}$	Zero Gate Voltage Drain Current	$V_{DS} = -16\text{V}, V_{GS} = 0\text{V}$			-1	$\mu\text{A}$
$I_{GSS}$	Gate to Source Leakage Current	$V_{GS} = \pm 8\text{V}, V_{DS} = 0\text{V}$			$\pm 100$	nA

#### On Characteristics

$V_{GS(th)}$	Gate to Source Threshold Voltage	$V_{GS} = V_{DS}, I_D = -250\mu\text{A}$	-0.4	-0.6	-1.5	V
$\frac{\Delta V_{GS(th)}}{\Delta T_J}$	Gate to Source Threshold Voltage Temperature Coefficient	$I_D = -250\mu\text{A}$ , referenced to $25^\circ\text{C}$		2		mV/ $^\circ\text{C}$
$r_{DS(on)}$	Drain to Source On Resistance	$V_{GS} = -4.5\text{V}, I_D = -1\text{A}$		67	85	m $\Omega$
		$V_{GS} = -2.5\text{V}, I_D = -1\text{A}$		85	123	
		$V_{GS} = -1.5\text{V}, I_D = -1\text{A}$		140	200	
		$V_{GS} = -4.5\text{V}, I_D = -1\text{A}, T_J = 125^\circ\text{C}$		87	123	
$I_{D(on)}$	On to State Drain Current	$V_{GS} = -4.5\text{V}, V_{DS} = -5\text{V}$	-10			A
$g_{FS}$	Forward Transconductance	$V_{DS} = -5\text{V}, I_D = -1\text{A}$		7		S

#### Dynamic Characteristics

$C_{iss}$	Input Capacitance	$V_{DS} = -10\text{V}, V_{GS} = 0\text{V}, f = 1\text{MHz}$		800		pF
$C_{oss}$	Output Capacitance			155		pF
$C_{rss}$	Reverse Transfer Capacitance			90		pF
$R_g$	Gate Resistance	$f = 1\text{MHz}$		9		$\Omega$

#### Switching Characteristics

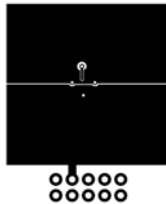
$t_{d(on)}$	Turn-On Delay Time	$V_{DD} = -10\text{V}, I_D = -1\text{A}$ $V_{GS} = -4.5\text{V}, R_{GEN} = 6\Omega$		11	20	ns
$t_r$	Rise Time			10	20	ns
$t_{d(off)}$	Turn-Off Delay Time			50	80	ns
$t_f$	Fall Time			30	48	ns
$Q_g(TOT)$	Total Gate Charge at 10V	$V_{GS} = 0\text{V}$ to 10V	$V_{DD} = -10\text{V}$	9	13	nC
$Q_{gs}$	Gate to Source Gate Charge		$I_D = -1\text{A}$	1		nC
$Q_{gd}$	Gate to Drain "Miller" Charge			2		nC

#### Drain-Source Diode Characteristics

$I_S$	Maximum continuous Drain-Source Diode Forward Current				-1.1	A
$V_{SD}$	Source to Drain Diode Forward Voltage	$V_{GS} = 0\text{V}, I_S = -1.1\text{A}$ (Note 2)		-0.7	-1.2	V
$t_{rr}$	Reverse Recovery Time	$I_F = -1\text{A}, di/dt = 100\text{A}/\mu\text{s}$		21		ns
$Q_{rr}$	Reverse Recovery Charge			5		nC

#### Notes:

1:  $R_{\theta JA}$  is determined with the device mounted on a  $1\text{in}^2$  pad 2 oz copper pad on a  $1.5 \times 1.5$  in. board of FR-4 material. The thermal resistance from the junction to the circuit board side of the solder ball,  $R_{\theta JB}$  is defined for reference. For  $R_{\theta JC}$  the thermal reference point for the case is defined as the top surface of the copper chip carrier.  $R_{\theta JC}$  and  $R_{\theta JB}$  are guaranteed by design while  $R_{\theta JA}$  is determined by the user's board design.



a.  $65^\circ\text{C}/\text{W}$  when mounted on a  $1\text{in}^2$  pad of 2 oz copper,  $1.5" \times 1.5" \times 0.062"$  thick PCB



b.  $133^\circ\text{C}/\text{W}$  when mounted on a minimum pad of 2 oz copper

2: Pulse Test: Pulse Width <  $300\mu\text{s}$ , Duty cycle < 2.0%.

**Typical Characteristics**  $T_J = 25^\circ\text{C}$  unless otherwise noted

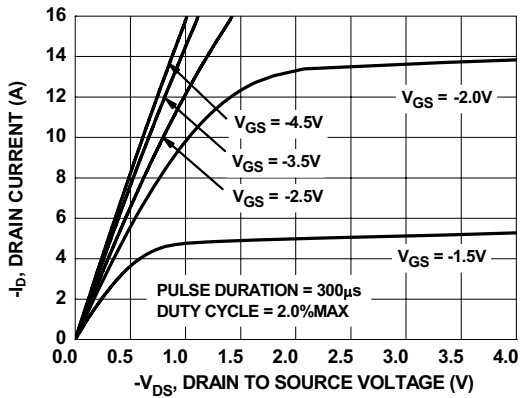


Figure 1. On Region Characteristics

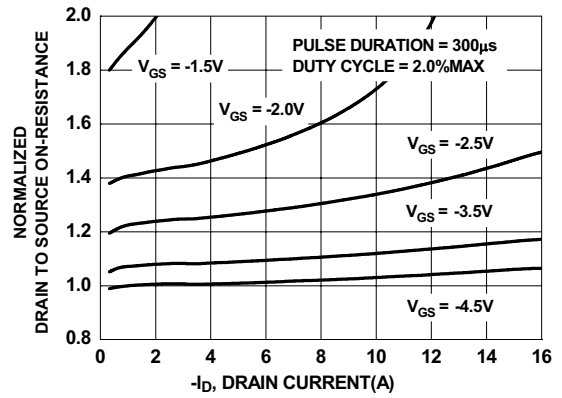


Figure 2. Normalized On-Resistance vs Drain Current and Gate Voltage

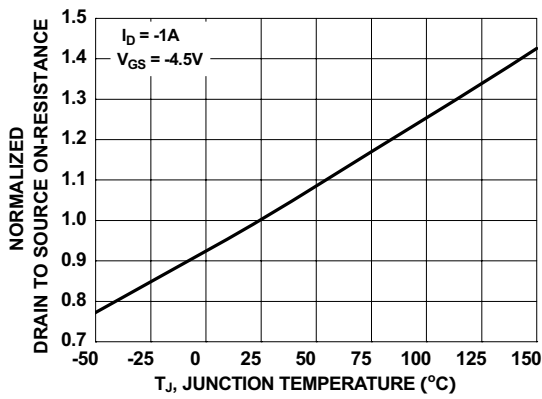


Figure 3. Normalized On Resistance vs Junction Temperature

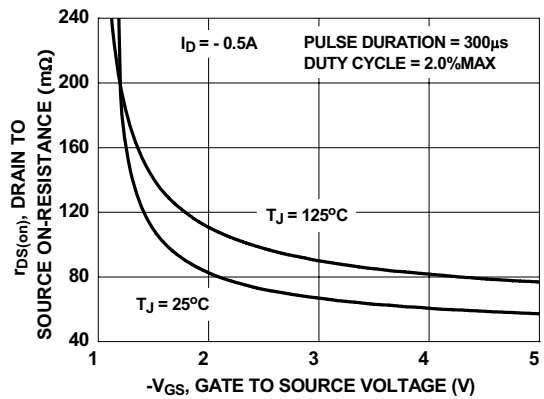


Figure 4. On-Resistance vs Gate to Source Voltage

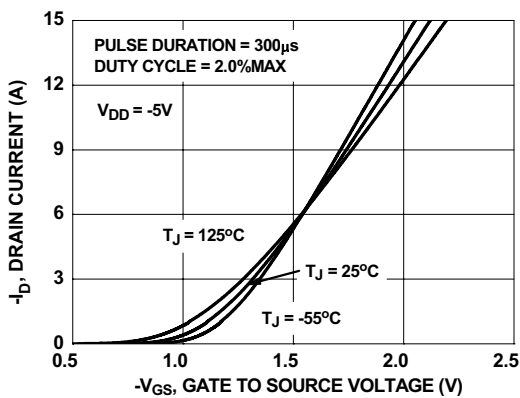


Figure 5. Transfer Characteristics

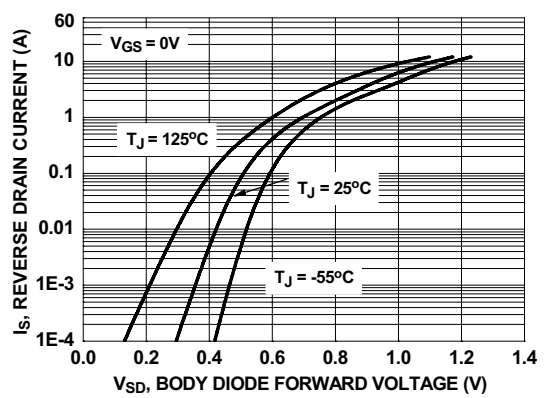
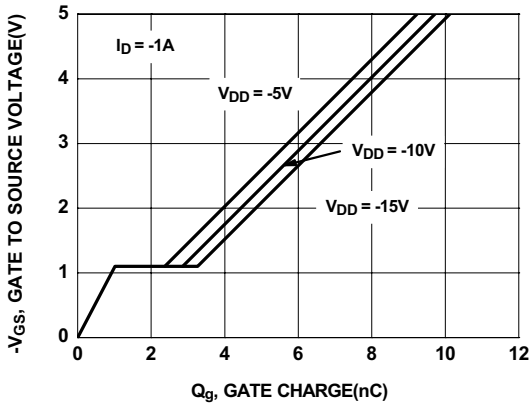
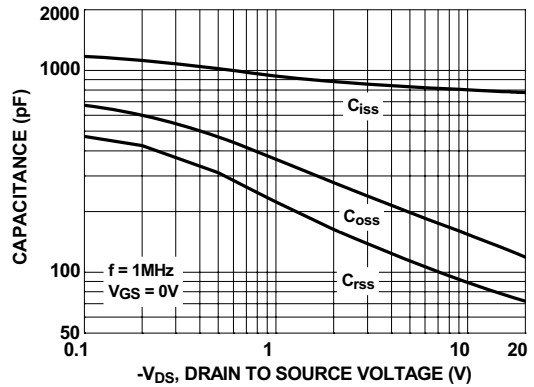


Figure 6. Source to Drain Diode Forward Voltage vs Source Current

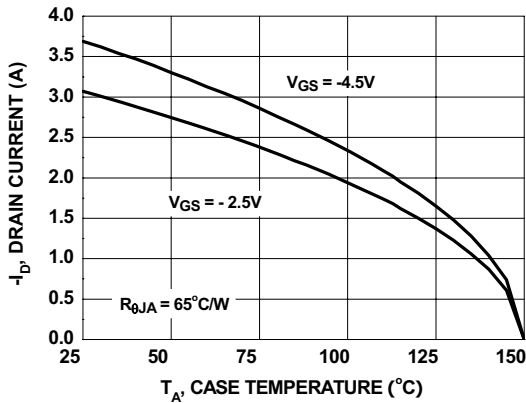
**Typical Characteristics**  $T_J = 25^\circ\text{C}$  unless otherwise noted



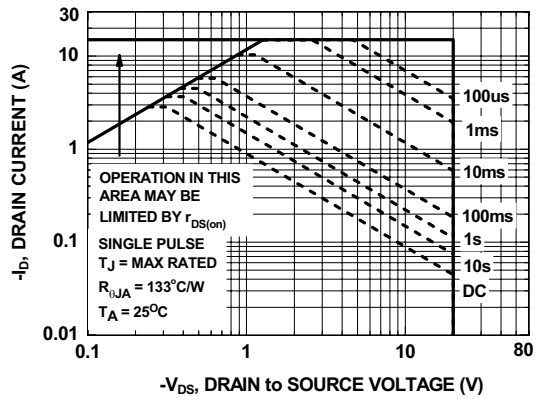
**Figure 7. Gate Charge Characteristics**



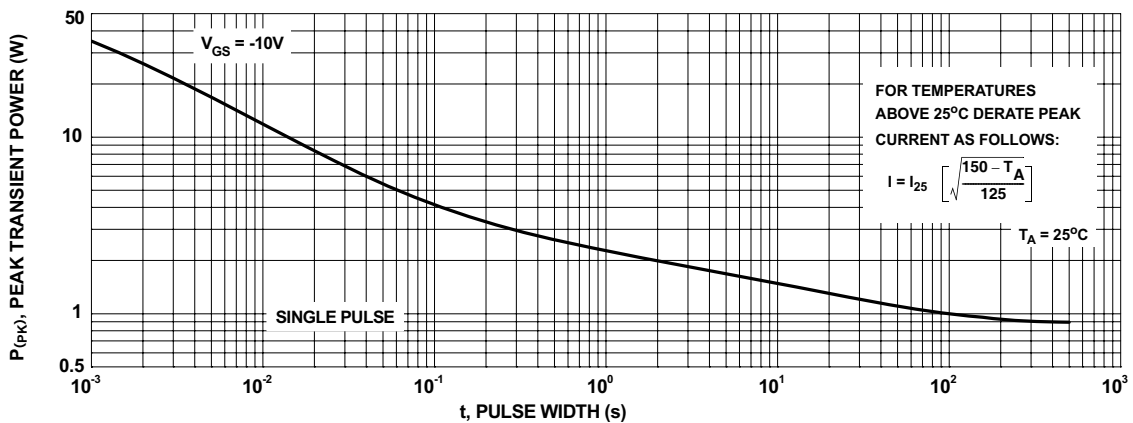
**Figure 8. Capacitance vs Drain to Source Voltage**



**Figure 9. Maximum Continuous Drain Current vs Ambient Temperature**

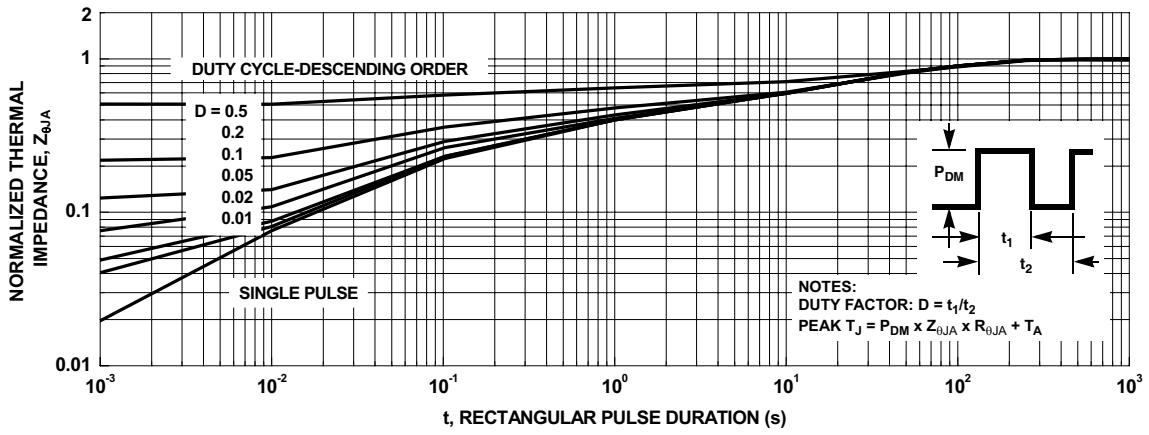


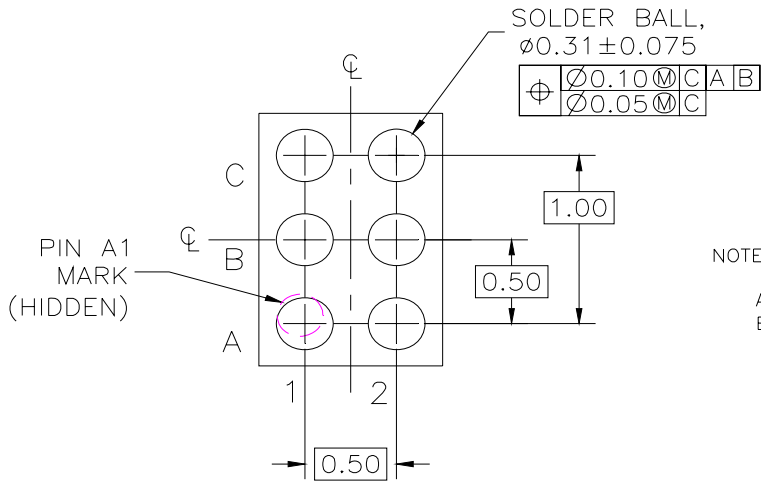
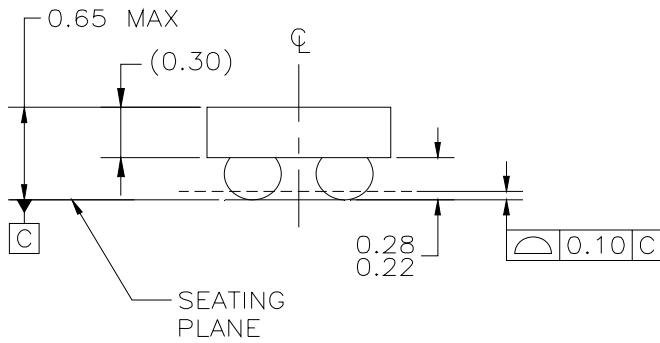
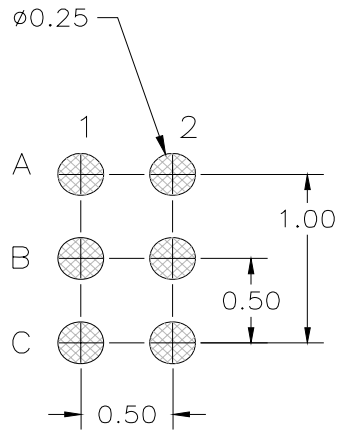
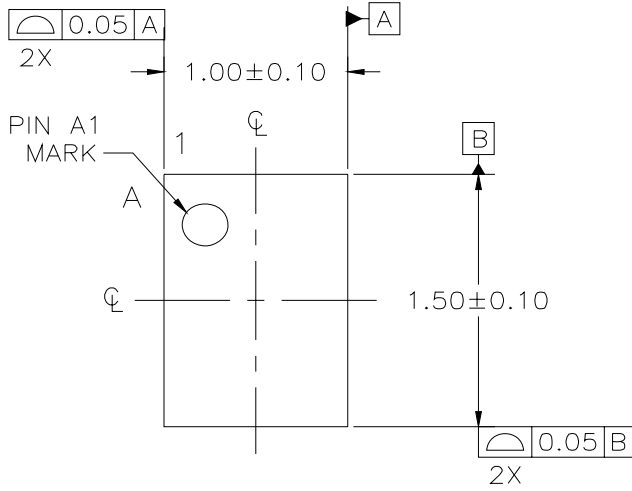
**Figure 10. Forward Bias Safe Operating Area**



**Figure 11. Single Pulse Maximum Power Dissipation**

**Typical Characteristics**  $T_J = 25^\circ\text{C}$  unless otherwise noted





NOTES: UNLESS OTHERWISE SPECIFIED







- A) ALL DIMENSIONS ARE IN MILLIMETERS.
- B) NO JEDEC REGISTRATION REFERENCE AS OF OCTOBER 2005.

UC006AAREVC



**TRADEMARKS**

The following includes registered and unregistered trademarks and service marks, owned by Fairchild Semiconductor and/or its global subsidiaries, and is not intended to be an exhaustive list of all such trademarks.

- |   |   |   |   |
|---|---|---|---|
| Auto-SPM™   | F-PFS™  | PowerTrench®  | The Power Franchise®  |
| Build it Now™   | FRFET®  | PowerXS™  | the power franchise®  |
| CorePLUS™   | Global Power Resource <sup>SM</sup>   | Programmable Active Droop™  | TinyBoost™  |
| CorePOWER™  | Green FPS™  | QFET®   | TinyBuck™   |
| CROSSVOLT™  | Green FPS™ e-Series™  | QS™   | TinyLogic®  |
| CTL™  | Gmax™   | Quiet Series™   | TINYOPTO™   |
| Current Transfer Logic™   | GTO™  | RapidConfigure™   | TinyPower™  |
| EcoSPARK®   | IntelliMAX™   |  Saving our world, 1mW /W /kW at a time™ | TinyPWM™  |
| EfficientMax™   | ISOPLANAR™  | SmartMax™   | TinyWire™   |
| EZSWITCH™ *   | MegaBuck™   | SMART START™  | TriFault Detect™  |
|  | MICROCOUPLER™   | SPM®  | TRUECURRENT™*   |
|  | MicroFET™   | STEALTH™  | uSerDes™  |
| Fairchild®  | MicroPak™   | SuperFET™   |  |
| Fairchild Semiconductor®  | MillerDrive™  | SuperSOT™-3   | UHC®  |
| FACT Quiet Series™  | MotionMax™  | SuperSOT™-6   | Ultra FRFET™  |
| FACT®   | Motion-SPM™   | SuperSOT™-8   | UniFET™   |
| FAST®   | OPTOLOGIC®  | SupreMOS™   | VCX™  |
| FastvCore™  | OPTOPLANAR®   | SyncFET™  | VisualMax™  |
| FETBench™   |  | Sync-Lock™  | XS™   |
| FlashWriter® *  | PDP SPM™  |    |   |
| FPS™  | Power-SPM™  |   |   |

\*Trademarks of System General Corporation, used under license by Fairchild Semiconductor.

**DISCLAIMER**

FAIRCHILD SEMICONDUCTOR RESERVES THE RIGHT TO MAKE CHANGES WITHOUT FURTHER NOTICE TO ANY PRODUCTS HEREIN TO IMPROVE RELIABILITY, FUNCTION, OR DESIGN. FAIRCHILD DOES NOT ASSUME ANY LIABILITY ARISING OUT OF THE APPLICATION OR USE OF ANY PRODUCT OR CIRCUIT DESCRIBED HEREIN; NEITHER DOES IT CONVEY ANY LICENSE UNDER ITS PATENT RIGHTS, NOR THE RIGHTS OF OTHERS. THESE SPECIFICATIONS DO NOT EXPAND THE TERMS OF FAIRCHILD'S WORLDWIDE TERMS AND CONDITIONS, SPECIFICALLY THE WARRANTY THEREIN, WHICH COVERS THESE PRODUCTS.

**LIFE SUPPORT POLICY**

FAIRCHILD'S PRODUCTS ARE NOT AUTHORIZED FOR USE AS CRITICAL COMPONENTS IN LIFE SUPPORT DEVICES OR SYSTEMS WITHOUT THE EXPRESS WRITTEN APPROVAL OF FAIRCHILD SEMICONDUCTOR CORPORATION.

As used herein:

- Life support devices or systems are devices or systems which, (a) are intended for surgical implant into the body or (b) support or sustain life, and (c) whose failure to perform when properly used in accordance with instructions for use provided in the labeling, can be reasonably expected to result in a significant injury of the user.
- A critical component in any component of a life support, device, or system whose failure to perform can be reasonably expected to cause the failure of the life support device or system, or to affect its safety or effectiveness.

**ANTI-COUNTERFEITING POLICY**

Fairchild Semiconductor Corporation's Anti-Counterfeiting Policy. Fairchild's Anti-Counterfeiting Policy is also stated on our external website, [www.Fairchildsemi.com](http://www.Fairchildsemi.com), under Sales Support.

Counterfeiting of semiconductor parts is a growing problem in the industry. All manufactures of semiconductor products are experiencing counterfeiting of their parts. Customers who inadvertently purchase counterfeit parts experience many problems such as loss of brand reputation, substandard performance, failed application, and increased cost of production and manufacturing delays. Fairchild is taking strong measures to protect ourselves and our customers from the proliferation of counterfeit parts. Fairchild strongly encourages customers to purchase Fairchild parts either directly from Fairchild or from Authorized Fairchild Distributors who are listed by country on our web page cited above. Products customers buy either from Fairchild directly or from Authorized Fairchild Distributors are genuine parts, have full traceability, meet Fairchild's quality standards for handling and storage and provide access to Fairchild's full range of up-to-date technical and product information. Fairchild and our Authorized Distributors will stand behind all warranties and will appropriately address and warranty issues that may arise. Fairchild will not provide any warranty coverage or other assistance for parts bought from Unauthorized Sources. Fairchild is committed to combat this global problem and encourage our customers to do their part in stopping this practice by buying direct or from authorized distributors.

**PRODUCT STATUS DEFINITIONS**

**Definition of Terms**

Datasheet Identification	Product Status	Definition
Advance Information	Formative / In Design	Datasheet contains the design specifications for product development. Specifications may change in any manner without notice.
Preliminary	First Production	Datasheet contains preliminary data; supplementary data will be published at a later date. Fairchild Semiconductor reserves the right to make changes at any time without notice to improve design.
No Identification Needed	Full Production	Datasheet contains final specifications. Fairchild Semiconductor reserves the right to make changes at any time without notice to improve the design.
Obsolete	Not In Production	Datasheet contains specifications on a product that is discontinued by Fairchild Semiconductor. The datasheet is for reference information only.

Rev. I40