

Dual operational amplifier

BA728/BA728F/BA728N

The BA728, BA728F, and BA728N are ICs with two independently functioning operational amplifiers featuring internal phase compensation. These products offer a wide range of operating voltages, from 3 to 18V (± 1.5 to 9V) and are high-performance operational amplifiers which can be driven from a single power supply within the in-phase mode input range, including a negative power supply.

●Applications

Ground sensing small-signal amplifiers
Control amplifiers requiring high phase margin, such as motor drivers

Amplifiers operated on low voltages
Capacitive loaded amplifiers

●Features

- 1) Can be driven from a single power supply.
- 2) Low power.
- 3) Pin layout is the same as that of the general-purpose 4558 operational amplifier.
- 4) When driven from a single power supply, the power supply voltage ranges from 3 to 18V.
- 5) When driven from a dual power supply, the power supply voltage ranges from ± 1.5 to $\pm 9V$.
- 6) Output is protected against short-circuits.
- 7) Output block is operated as a class AB to minimize crossover distortion.
- 8) Low input bias current of 10nA (typ.).
- 9) Each package contains two operational amplifiers.
- 10) Internal phase compensation provided.

●Block diagram

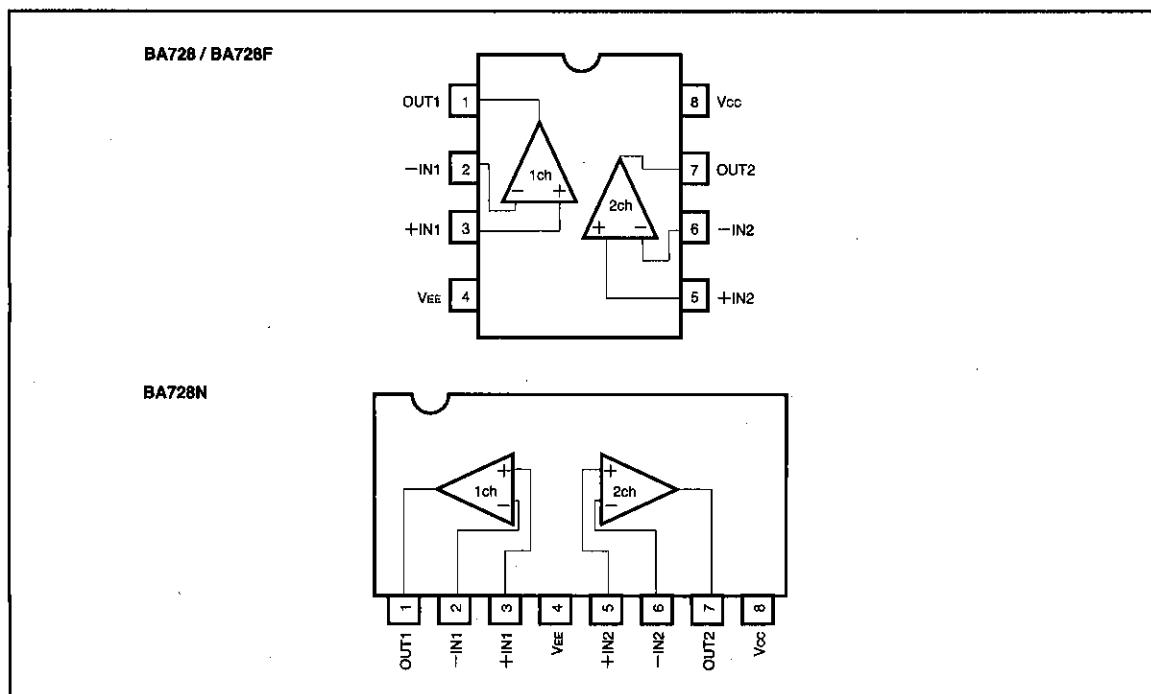

● Internal circuit configuration diagram

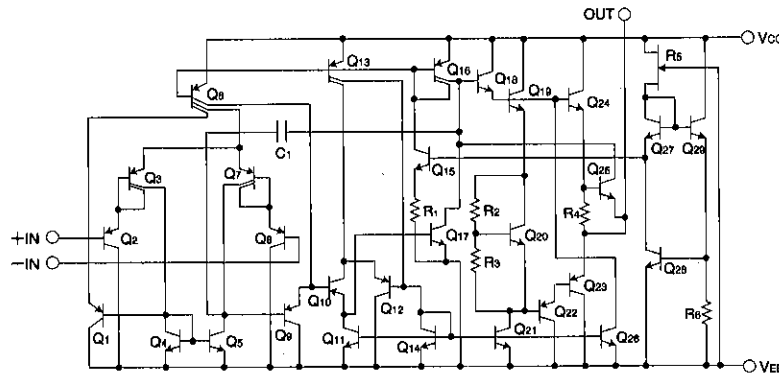

● Absolute maximum ratings (Ta=25°C)

Parameter	Symbol	Limits			Unit
		BA728	BA728F	BA728N	
Power supply voltage	V _{CC}	18 (±9)	18 (±9)	18 (±9)	V
Power dissipation	P _d	600*	450*	900*	mW
Differential input voltage	V _{IO}	V _{CC}	V _{CC}	V _{CC}	V
In-phase input voltage	V _I	-0.3~V _{CC}	-0.3~V _{CC}	-0.3~V _{CC}	V
Operating temperature	T _{opr}	-20~75	-20~75	-20~75	°C
Storage temperature	T _{stg}	-55~125	-55~125	-55~125	°C

* For P_d values, please see P_d characteristic diagram.

* Values are those when BA728F is mounted on a glass epoxy PCB (50 mm x 50 mm x 1.6 mm).

● Electrical characteristics (unless otherwise noted, Ta=25°C, V_{CC}=+6V, V_{EE}=-6V)

Parameter	Symbol	Min.	Typ.	Max.	Unit	Conditions	
Input offset voltage	V _{IO}	—	2	10	mV	—	
Input offset current	I _{IO}	—	1	50	nA	—	
Input bias current	I _B	—	10	250	nA	—	
High amplitude voltage gain	A _v	86	100	—	dB	R _L ≥2kΩ	
Common mode input voltage	V _{ICM}	4~-6	4.5~-6	—	V	—	
Maximum output voltage	V _{OM}	±3.0	±4.5	—	V	R _L ≥2kΩ	
Common mode rejection ratio	CMRR	70	90	—	dB	—	
Power supply voltage rejection ratio	PSRR	—	30	150	μV/V	—	
Slew rate	S. R.	—	0.7	—	V/μS	A _v =1, R _L =2kΩ	
Maximum frequency	f _r	—	0.7	—	MHz	—	
Channel separation	CS	—	120	—	dB	—	
Maximum output current	source	I _{source}	—	20	—	mA	V _{IN+} =1V, V _{IN-} =0V
	sink	I _{sink}	—	10	—	mA	V _{IN-} =1V, V _{IN+} =0V

● Measurement circuits

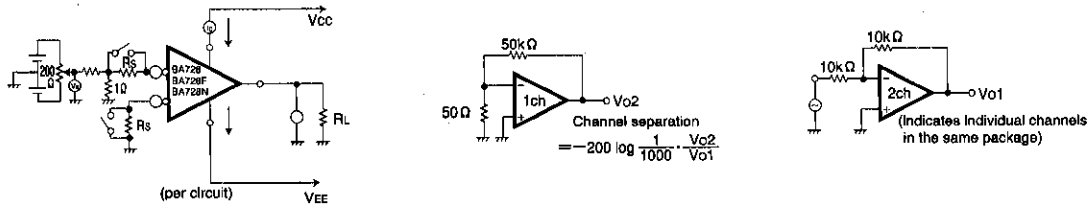

Fig. 1 Channel separation measurement circuit

● Electrical characteristic curves

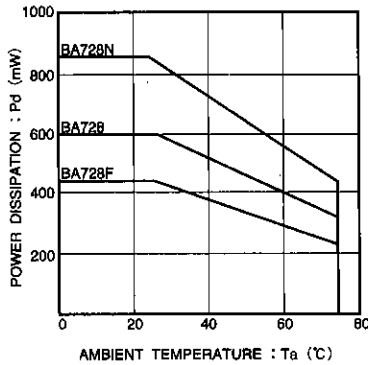

Fig. 2 Power dissipation - ambient temperature characteristic

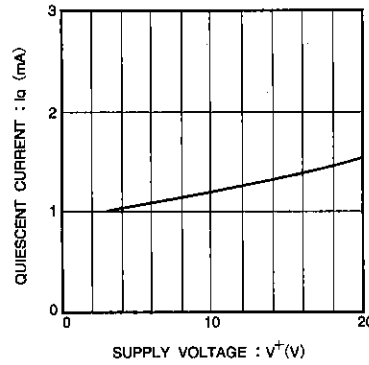

Fig. 3 Quiescent current - power supply voltage characteristic

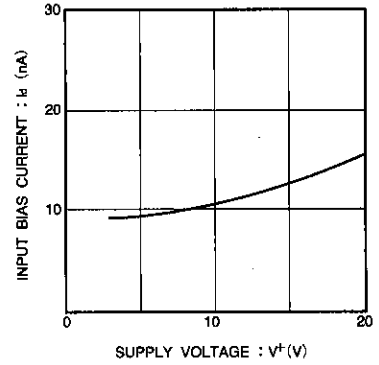

Fig. 4 Input bias current - power supply voltage characteristic

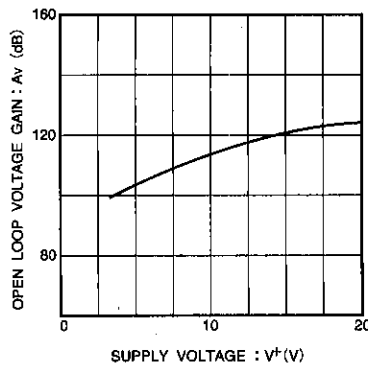

Fig. 5 Open loop voltage gain - power supply voltage characteristic

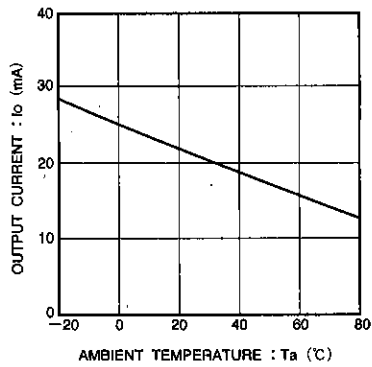

Fig. 6 Current control characteristic

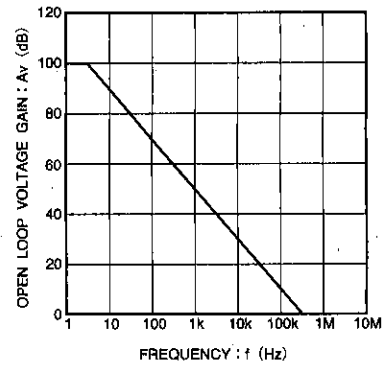

Fig. 7 Open loop voltage gain - frequency characteristic

●Electrical characteristic curve

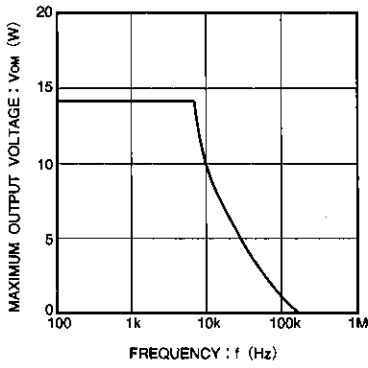

Fig.8 Maximum output voltage - frequency characteristic

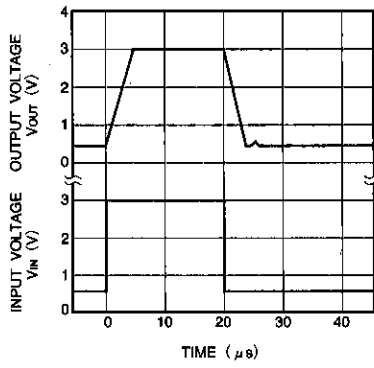

Fig.9 Output response characteristic

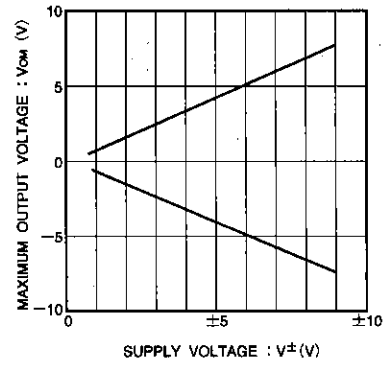

Fig.10 Maximum output voltage - power supply voltage characteristic

●Operation notes

Unused circuit connections

If there are any circuits which are not being used, we recommend making connections as shown in Figure 11, with the non-inverted input pin connected to the potential within the in-phase input voltage range (V_{ICM}).

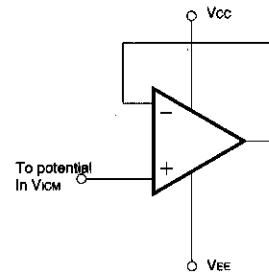

Fig.11 Unused circuit connections

●External dimensions (Units: mm)

