

# High-output dual power amplifier

## BA5415A/BA5416

The BA5415A and BA5416 are dual power amplifier ICs that operate off a 9V to 15V supply. When driving a 4Ω load off a 9V supply, the BA5415A does not require a heatsink. The BA5416 uses a lost-cost package. The basic characteristics (total harmonic distortion etc.) of the amplifiers are excellent, and both ICs include a standby switch function.

### ●Applications

Radio cassette players.

### ●Features

- 1) High output.  
 $P_{OUT} = 5.4W$  ( $V_{CC} = 12V$ ,  $R_L = 3\Omega$  and THD = 10%)  
 $P_{OUT} = 2.5W$  ( $V_{CC} = 9V$ ,  $R_L = 4\Omega$  and THD = 10%)
- 2) Excellent audio quality.  
 THD = 0.1% ( $f = 1kHz$ ,  $P_o = 0.5W$ )  
 $V_{NO} = 0.3mV_{rms}$  ( $R_g = 10k\Omega$ )  
 RR = 60dB ( $f_{RR} = 100Hz$ )
- 3)  $V_{CC} = 5.0V$  to 18.0V (BA5416 : 5.0V to 15.0V)
- 4) Switching noise ("pop" noise) generated when the power is switched on and off is small.
- 5) Ripple mixing when motor starts has been prevented.
- 6) Built-in thermal shutout.
- 7) Built-in standby switch. Output is not influenced by the standby pin voltage.
- 8) "On" mute time does not depend on  $V_{CC}$ .
- 9) Soft clipping.
- 10) Heatsink not required (for BA5415A, with  $V_{CC} = 9V$  and  $R_L \geq 4\Omega$ ).

### ●Absolute maximum ratings ( $T_a = 25^\circ C$ )

Parameter	Symbol	Limits	Unit
Supply voltage	$V_{CC}$	24* <sup>1</sup>	V
Power dissipation	BA5415A	Pd	20* <sup>2</sup>
			4.0* <sup>3</sup>
			15* <sup>4</sup>
BA5416			
Operating temperature	$T_{opr}$	-25~75	°C
Storage temperature	$T_{stg}$	-55~150	°C

\* 1 Within ASO.

\* 2  $T_a = 75^\circ C$  (see Fig. 10).

\* 3 Reduced by 40mW for each increase in  $T_a$  of 1°C over 25°C.(without radiation board)

\* 4  $T_a = 75^\circ C$  (see Fig. 11).

### ●Recommended operating conditions ( $T_a = 25^\circ C$ )

Parameter	Symbol	Min.	Typ.	Max.	Unit
Supply voltage	$V_{CC}$	5	12	18*	V

\* When BA5416 is 15V



●Electrical characteristics (unless otherwise specified  $T_a = 25^\circ\text{C}$ ,  $V_{cc} = 12\text{V}$ ,  $R_L = 3\ \Omega$ ,  $R_f = 240\ \Omega$ ,  $R_g = 600\ \Omega$ , and  $f = 1\text{kHz}$ )

Parameter	Symbol	Min.	Typ.	Max.	Unit	Conditions
Quiescent current	$I_Q$	—	28	45	mA	$V_{IN} = 0V_{rms}$
Maximum output voltage	$P_{OM}$	—	8.3	—	W	$V_{IN} = -20\text{dBm}$
Rated output 1	$P_{OUT1}$	4.5	5.4	—	W	THD=10%
Rated output 2	$P_{OUT2}$	2.0	2.5	—	W	THD=10%、 $V_{CC}=9\text{V}$ 、 $R_L=4\ \Omega$
Closed circuit voltage gain	$G_{VC}$	43	45	47	dB	
Output noise voltage	$V_{NO}$	—	0.3	1.0	$\text{mV}_{rms}$	$R_g = 10\text{k}\ \Omega$ 、DIN AUDIO
Total harmonic distortion	THD	—	0.1	0.7	%	$P_{OUT} = 0.5\text{W}$
Ripple rejection	RR	45	60	—	dB	$f_{RR} = 100\text{Hz}$ 、 $V_{RR} = -10\text{dBm}$
Crosstalk	CT	45	60	—	dB	$V_O = 0\text{dBm}$
Circuit current (ST. BY SW. OFF)	$I_{OFF}$	—	0	—	$\mu\text{A}$	
ST. BY PIN current (ST. BY SW. ON)	$I_{SIN}$	—	0.3	—	mA	$V_{ST.BY} = V_{CC}$
Input bias current	$I_{BIN}$	—	0.1	0.5	$\mu\text{A}$	$R_g = 0\ \Omega$

●Measurement circuit

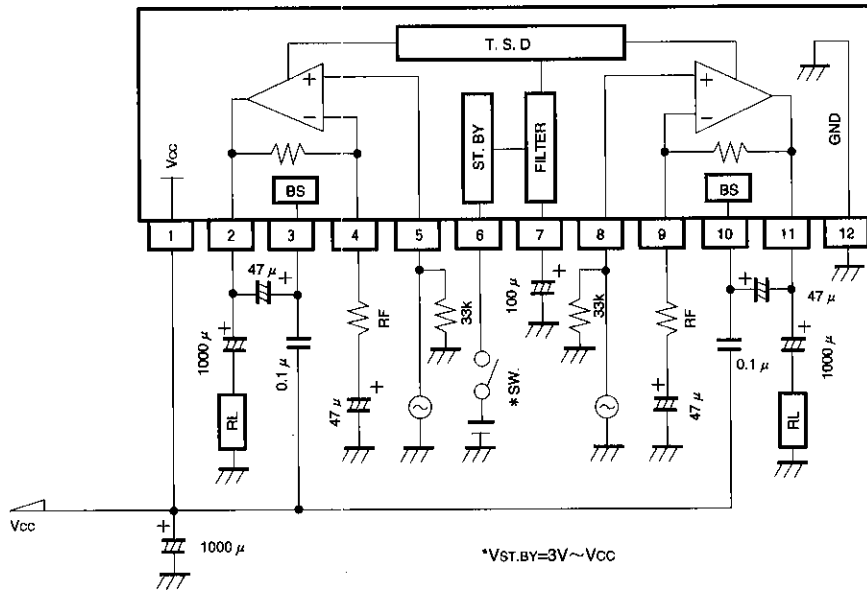

Fig. 1



● Operation notes

1. Input circuit

The structure of the input circuit is shown in Fig. 4. The IC can be used without coupling capacitors, but a maximum of 0.5 μA of bias current (I<sub>BIN</sub>) flows from the input pin, so if potentiometer sliding noise results from this, connect an input capacitor C<sub>IN</sub> as shown below.

To prevent degradation of the IC characteristics, the input bias resistor is not built into the IC. Connect an input bias resistor (R<sub>IN</sub>) between the input and GND (the recommended value is about 33kΩ).

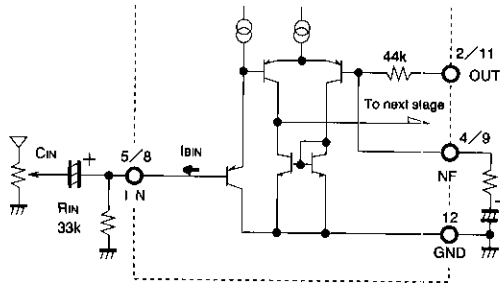

Fig. 4

2. Gain adjustment

The gain is given by the following formula.

$$G_v = 20 \log \frac{R_{NF} + R_F}{R_F}$$

It is possible to reduce the gain by increasing R<sub>F</sub>, but the amount of feedback will increase, and oscillation will be more likely to occur. We recommend that you set the gain to 30dB or higher.

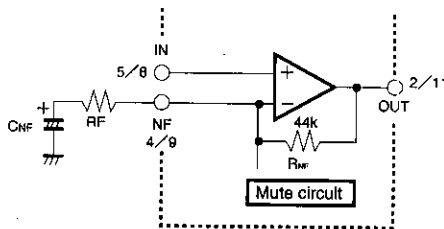

Fig. 5

3. Oscillation countermeasures

We recommend that the capacitor (C1) connected between the B. S pin and the V<sub>CC</sub> pin for oscillation prevention be a metal-film component with good temperature and high-frequency characteristics.

Ceramic capacitors have poor temperature characteristics, so if used, allow sufficient oscillation margin. It is also possible to connect a capacitor for oscillation prevention between the output and GND (C2).

The oscillation margin depends on the PCB pattern and the mounting position of the capacitor. Design your PCB after referring to the application example PCB.

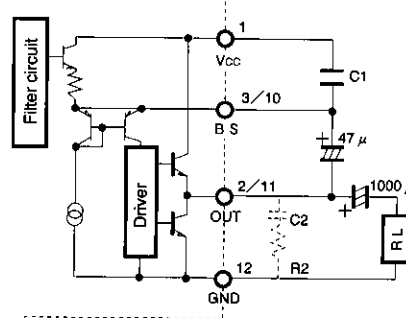

Fig. 6

4. V<sub>CC</sub> and GND lines

The Pre. GND and Pow. GND are joined at pin 12, so there is a chance of crosstalk or degraded distortion performance due to common ground impedance in the PCB pattern. In addition, the power supply capacitor connected between V<sub>CC</sub> and GND is influenced by the PCB pattern, and common V<sub>CC</sub> and GND impedance may degrade the ripple rejection and distortion. Design the PCB after referring to the application example PCB (the recommended value for the power supply capacitor is 1000 μF of greater).

● Operation notes

5. Standby switch

The IC has a built-in standby switch (pin 6), so the IC can be powered on and off by a switch with low current capacity. The on voltage  $V_1$  can be in the range 3V to  $V_{CC}$ , so the standby switch will not adversely influence circuit characteristics as with conventional methods. This also increases design freedom. At normal temperatures, the switch operates at a voltage of  $V_1 = 3V$  or higher, but we recommend that you use it at 3.5V or higher to allow for low temperatures.

A small "pop" noise may be generated when the power is switched off using the external switch. If this is the case, connect a capacitor of about  $C_3 = 0.022 \mu F$  in parallel with the switch.

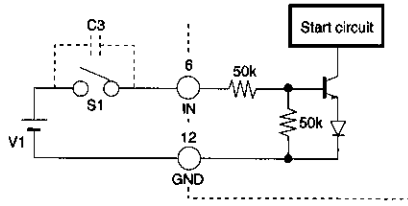

Fig. 7

6. Filter pin

Pin 7 is for connection of a ripple filter. The ripple rejection can be increased somewhat by increasing the capacitance, but this also affects the starting time, so we recommend a value in the range  $100 \mu F$  to  $220 \mu F$ . The standard starting time is 0.8sec.

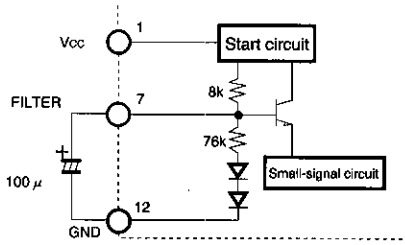

Fig. 8

7. Applied voltage

As long as the output power transistor is operated within the ASO (safe operating range Fig. 9), the IC can be operated to its absolute maximum ratings ( $V_{CCMAX.} = 24.0V$ ). During normal operation, operate the IC within its recommended operating voltage range; exceeding this range will result in destruction of the IC. When the standby switch is off, the IC is guaranteed up to  $V_{CCMAX.} = 24.0V$ , but when the standby switch is on, set the power supply regulation characteristics (including the capacitance of the power supply capacitor connected between  $V_{CC}$  and GND) so that  $V_{CC}$  is 18.0V or less (15.0V or less for the BA5416). If the IC is inserted backwards,  $V_{CC}$  and GND will be reversed and the IC will be destroyed instantly.

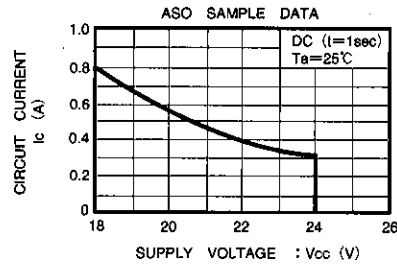

Fig. 9

8. Thermal shutdown

If the load is shorted or there is insufficient heat dissipation, the thermal shutdown circuit will operate limit the output and prevent damage to the IC. This occurs when the temperature of the heatsink plate exceeds a temperature of about 175°C.

9. Other

Provided the recommended circuit constants are used, the application circuit will function correctly. However, we recommend that you confirm the characteristics of the circuit in actual use. If you change the circuit constants, check both the static and transient characteristics of the circuit, and allow sufficient margin to accommodate variations in both ICs and external components.

10. Standard values for the DC voltages on each pin ( $V_{CC} = 12V$ ,  $T_a = 25^\circ C$ , test circuit : Fig. 1)

Pin No	1	2	3	4	5	6	7	8	9	10	11	12
DC (V)	$V_{CC}$	6.0	10.0	0.6	0.004	$V_{ST.BY}$	10.9	0.004	0.6	10.0	6.0	GND

Application example circuit PCB

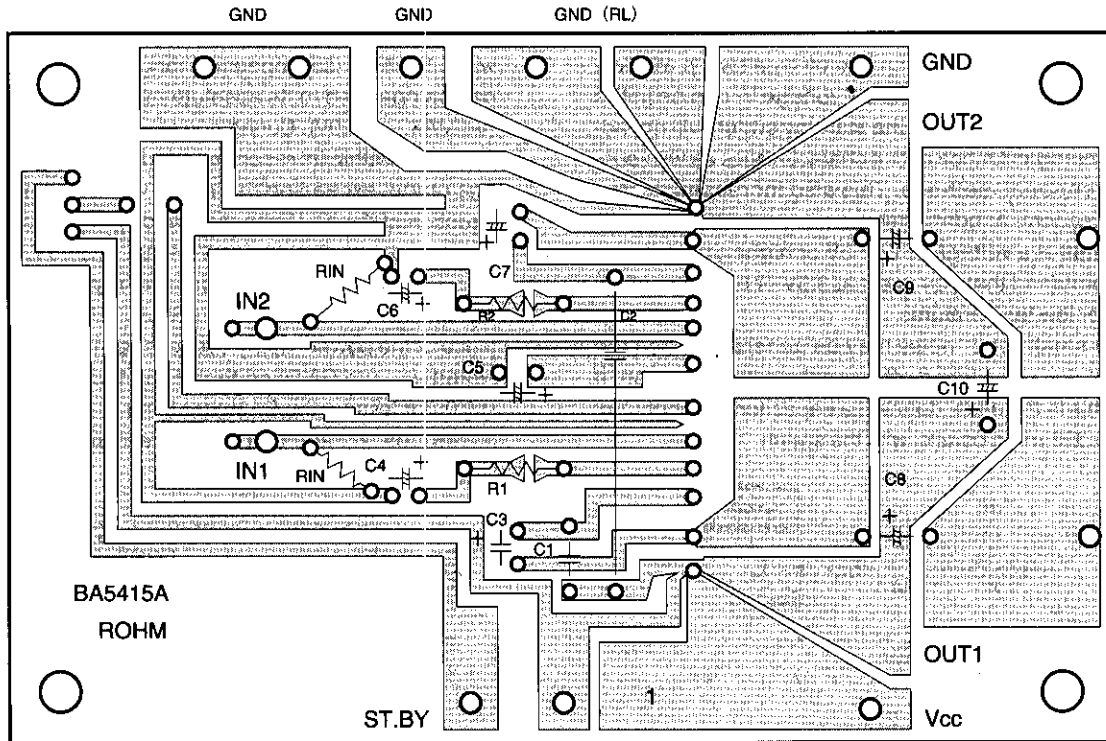

●Electrical characteristics curves

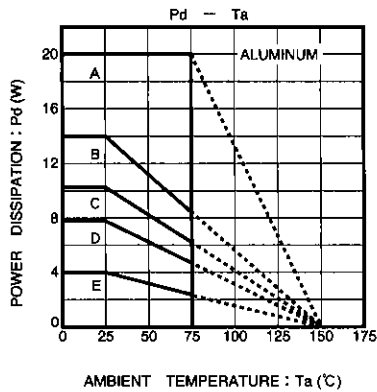

Fig. 10 Power dissipation curves (BA5415A)

- A : INFINITE HEAT SINK  $\theta_{jc}=3.75^{\circ}\text{C}/\text{W}$
- B :  $100\text{cm}^2 \times 1.6\text{mm}$
- C :  $50\text{cm}^2 \times 1.6\text{mm}$
- D :  $25\text{cm}^2 \times 1.6\text{mm}$
- E : WITHOUT HEAT SINK  $\theta_{ja}=31^{\circ}\text{C}/\text{W}$

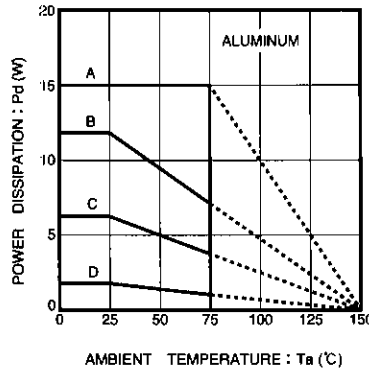

Fig. 11 Power dissipation curves (BA5416)

- A : INFINITE HEAT SINK  $\theta_{jc}=5.0^{\circ}\text{C}/\text{W}$
- B :  $100\text{cm}^2 \times 2.0\text{mm}$
- C :  $25\text{cm}^2 \times 2.0\text{mm}$
- D : WITHOUT HEAT SINK  $\theta_{ja}=56.8^{\circ}\text{C}/\text{W}$

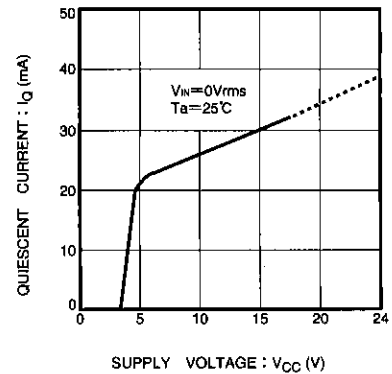

Fig. 12 Quiescent current vs. supply voltage

● Electrical characteristics curves

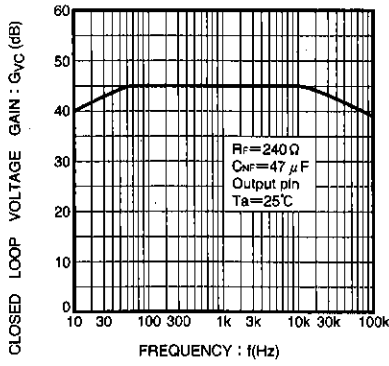

Fig. 13 Closed-circuit voltage gain vs. frequency

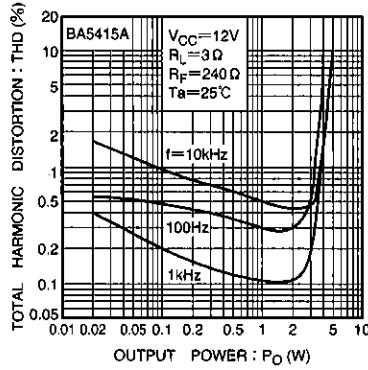

Fig. 14 Total harmonic distortion vs. output power (BA5415A)

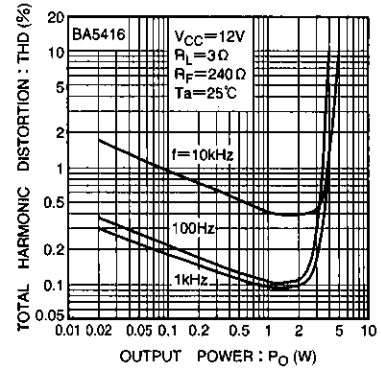

Fig. 15 Total harmonic distortion vs. output power (BA5416)

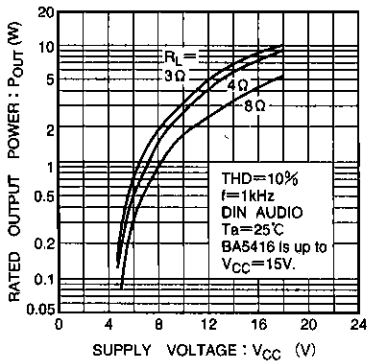

Fig. 16 Rated output voltage vs. supply voltage

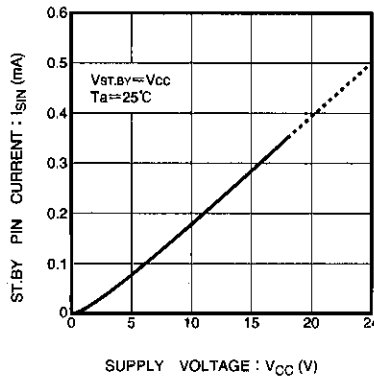

Fig. 17 Standby pin input current vs. supply voltage

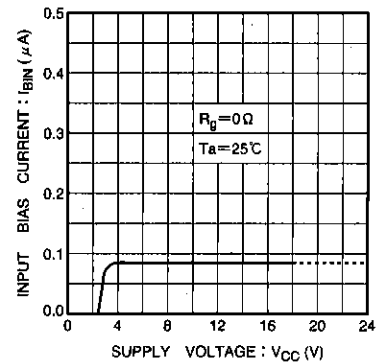

Fig. 18 Input bias current vs. supply voltage

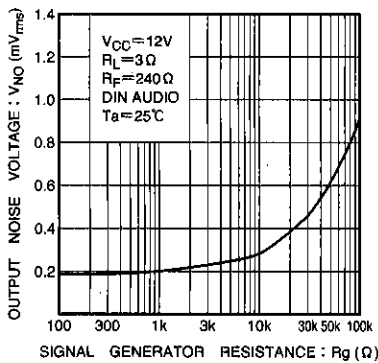

Fig. 19 Output noise voltage vs. signal source resistance

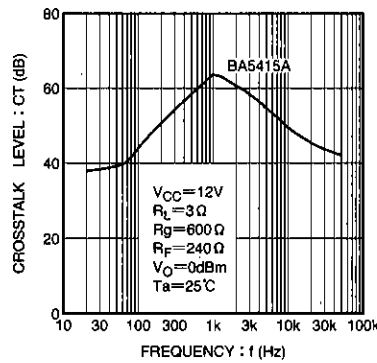

Fig. 20 Crosstalk vs. frequency (BA5415A)

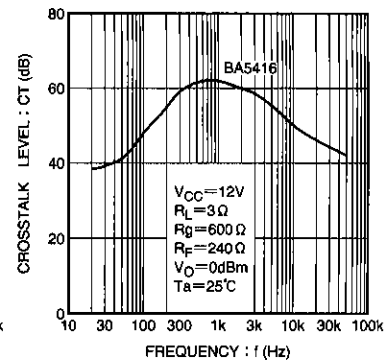

Fig. 21 Crosstalk vs. frequency (BA5416)

Power amplifiers

Low-frequency amplifiers



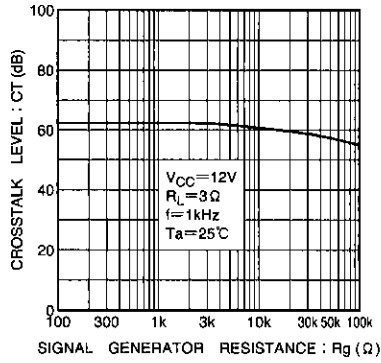

Fig. 22 Crosstalk vs. signal source resistance

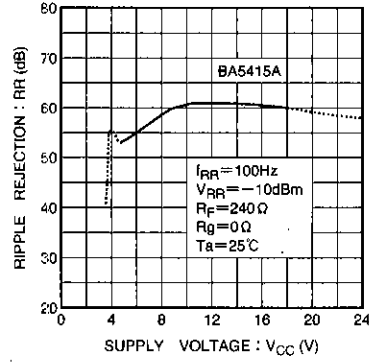

Fig. 23 Ripple rejection vs. supply voltage (BA5415A)

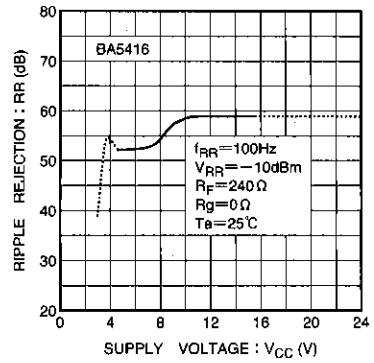

Fig. 24 Ripple rejection vs. supply voltage (BA5416)

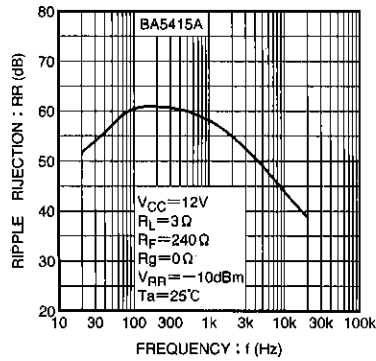

Fig. 25 Ripple rejection vs. frequency (BA5415A)

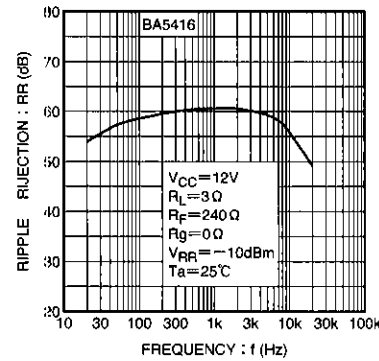

Fig. 26 Ripple rejection vs. frequency (BA5416)

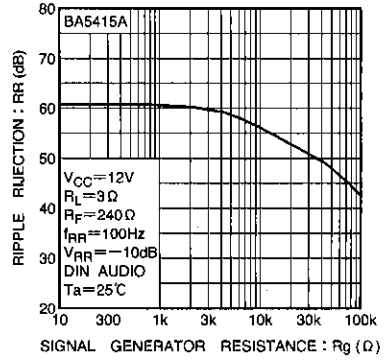

Fig. 27 Ripple rejection vs. signal source resistance (BA5416)

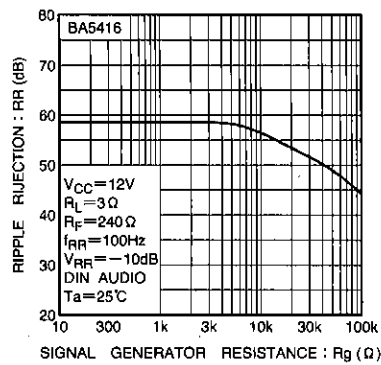

Fig. 28 Ripple rejection vs. signal source resistance (BA5416)

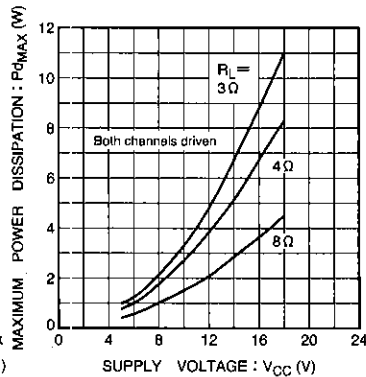

Fig. 29 Maximum power dissipation vs. supply voltage

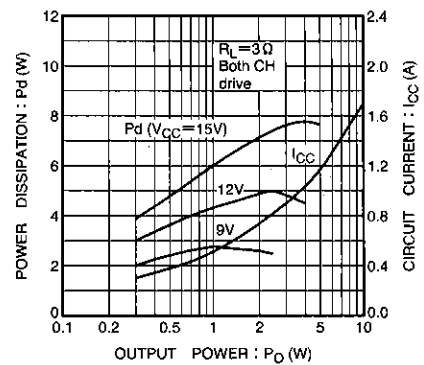

Fig. 30 Power dissipation and circuit current vs. supply voltage (RL = 3 Ohm)

●Electrical characteristics curves

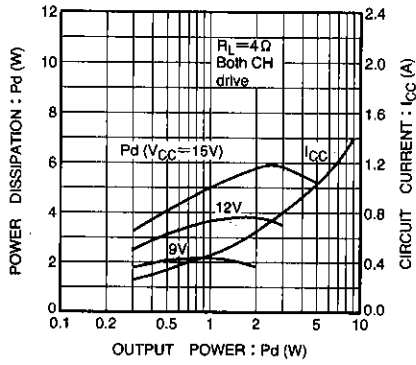
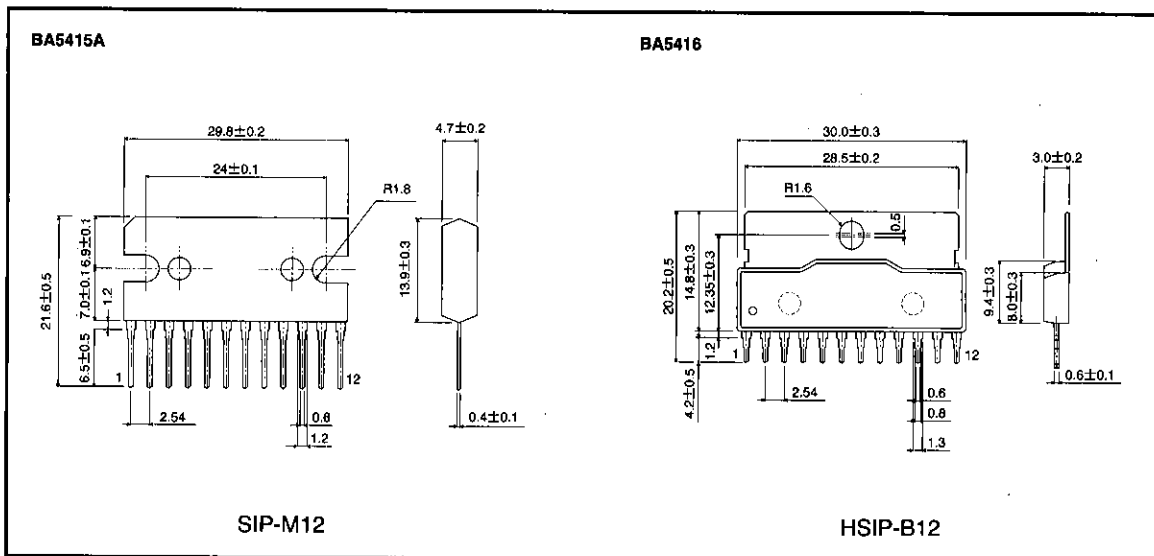

Fig. 31 Power dissipation and circuit current vs. supply voltage (RL = 4Ω)

●External dimensions (Unit: mm)



Power amplifiers

Low-frequency amplifiers