

FM front end

BA4402 / BA4404

The BA4402 and BA4404 are front end ICs for FM radio receivers. These devices can be used in a wide range of applications, from 3V portable radios to home stereo tuners.

The BA4402 and BA4404 consist of an RF amplifier, oscillator circuit, mixer circuit, and a variable capacitor-diode for AFC. They are pin compatible, and either can be selected depending on the amount of gain needed and other requirements of the application.

●Applications

FM pocket radios
Radio cassette players
Home stereos

●Features

- 1) Wide operating voltage range : 1.8 to 9V.
- 2) High gain with good stability.
- 3) An appropriate device can be selected depending on the need for AFC and the amount of gain required.

●Block diagram

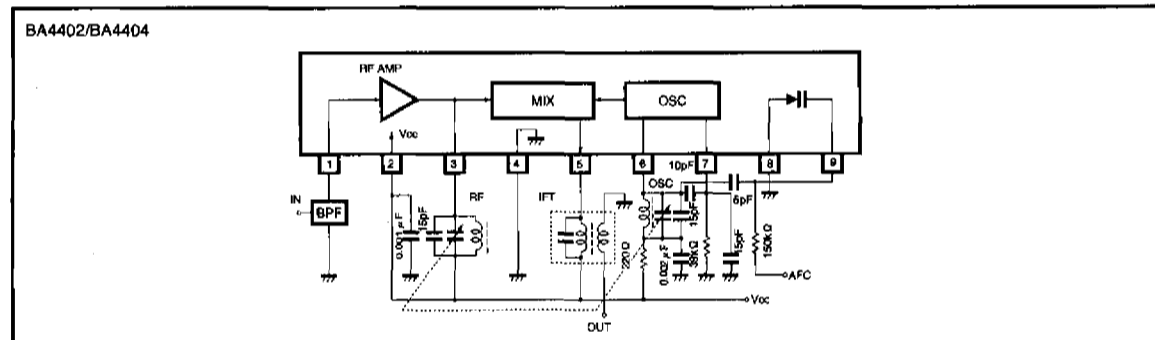

Product name	Variable capacitor	Gain	RF amplifier
BA4402	Yes	32dB	Common base
BA4404	Yes	38dB	Common emitter

● Absolute maximum ratings (Ta = 25°C)

Parameter	Symbol	Limits	Unit
Supply voltage	V _{CC}	9	V
Power dissipation	P _d	1000*1	mW
Operating temperature	T _{opr}	-25~75	°C
Storage temperature	T _{stg}	-55~125	°C

*1 At temperatures above Ta = 25°C, decreases 10 mW per degree.

● Electrical characteristics (unless otherwise indicated, Ta = 25°C and V_{CC} = 3V)

BA4402

Parameter	Symbol	Min.	Typ.	Max.	Unit	Conditions	Measurement Circuit
Quiescent current	I _Q	—	2.5	4.0	mA	—	Fig.1
Output voltage 1	V _{O1}	25	40	55	mV	f _{IN} =100MHz, 60dB μV	Fig.1
Output voltage 2	V _{O2}	80	120	160	mV	f _{IN} =100MHz, 100dB μV	Fig.1
Oscillator voltage	V _{OSC}	180	250	340	mV	V _{CC} =2V	Fig.1
Oscillation stop voltage	V _{STOP}	—	1.4	1.6	V	—	Fig.1

BA4404

Parameter	Symbol	Min.	Typ.	Max.	Unit	Conditions	Measurement Circuit
Quiescent current	I _Q	—	3.0	5.0	mA	—	Fig.1
Output voltage 1	V _{O1}	55	80	120	mV	f _{IN} =100MHz, 60dB μV	Fig.1
Output voltage 2	V _{O2}	80	120	160	mV	f _{IN} =100MHz, 100dB μV	Fig.1
Oscillator voltage	V _{OSC}	180	250	340	mV	V _{CC} =2V	Fig.1
Oscillation stop voltage	V _{STOP}	—	1.4	1.6	V	—	Fig.1

Front end

High-frequency signal processors

● Measurement circuit

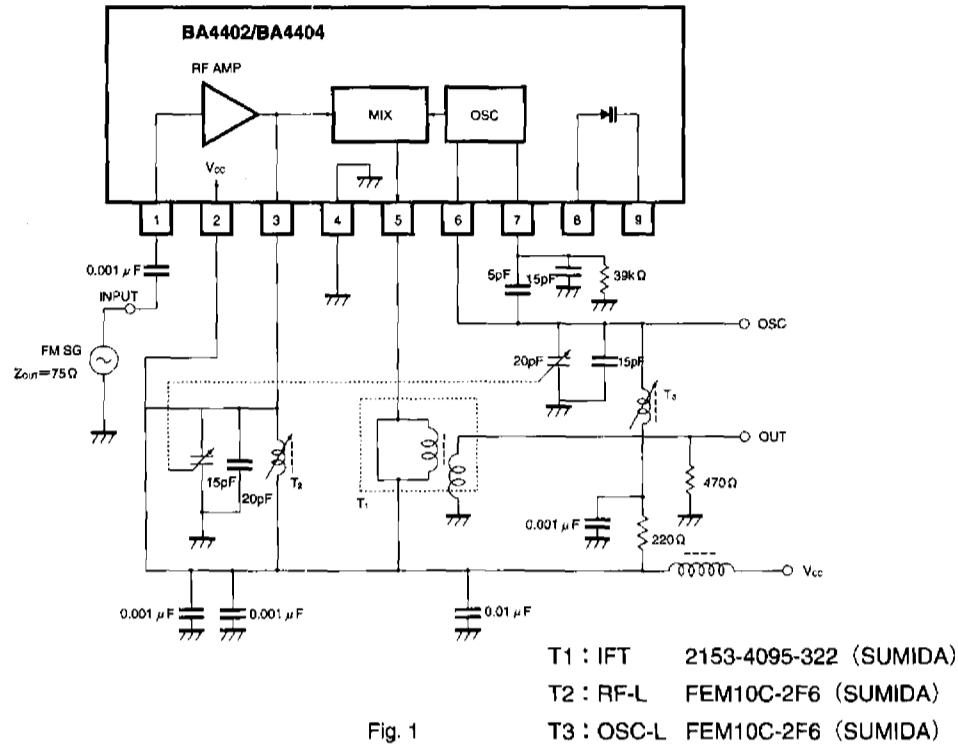

Fig. 1

● Application example

BA4402/BA4404

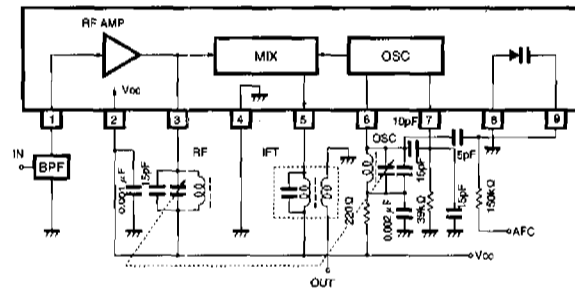

Fig. 2

●Electrical characteristic curves

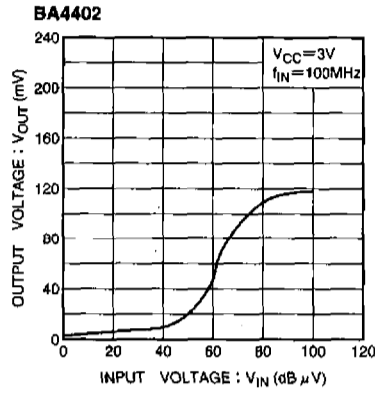

Fig. 3 Output voltage vs. input voltage

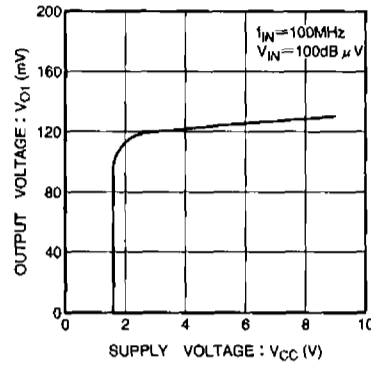

Fig. 4 Output voltage 1 vs. supply voltage

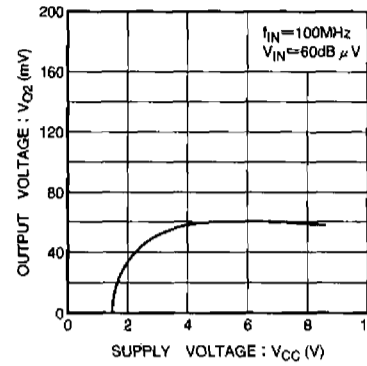

Fig. 5 Output voltage 2 vs. supply voltage

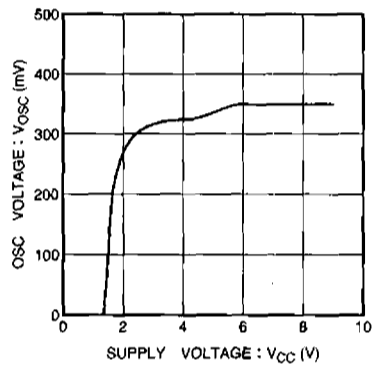

Fig. 6 Oscillator voltage vs. supply voltage

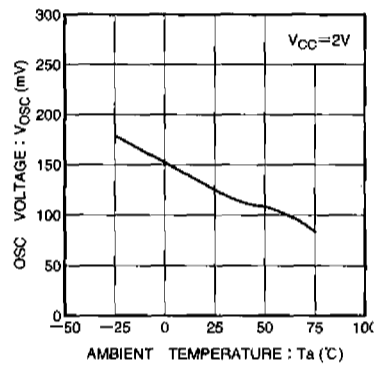

Fig. 7 Oscillator voltage vs. ambient temperature

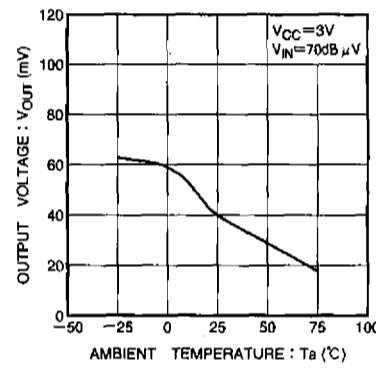

Fig. 8 Output voltage vs. ambient temperature

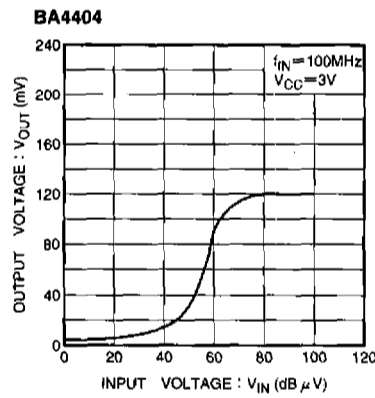

Fig. 9 Output voltage vs. input voltage

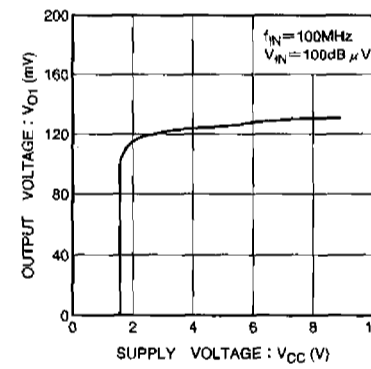

Fig. 10 Output voltage 1 vs. supply voltage

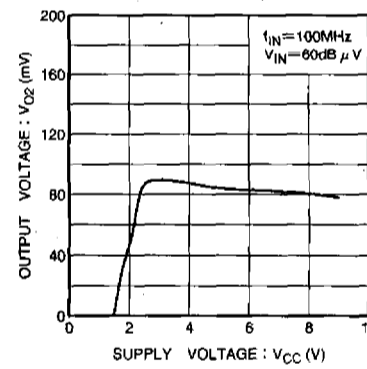

Fig. 11 Output voltage 2 vs. supply voltage

Front end

High-frequency signal processors

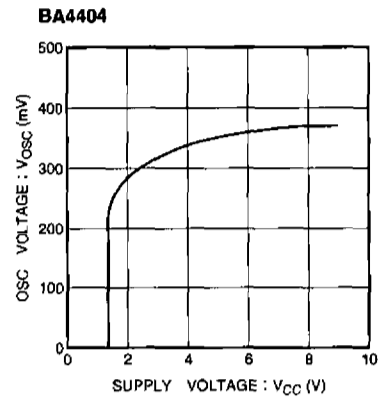

Fig. 12 Oscillator voltage vs. supply voltage

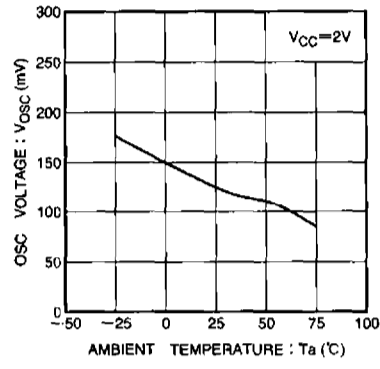

Fig. 13 Oscillator voltage vs. ambient temperature

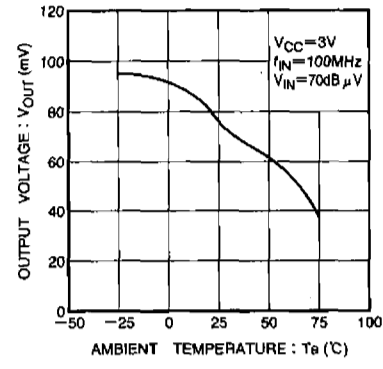

Fig. 14 Output voltage vs. ambient temperature

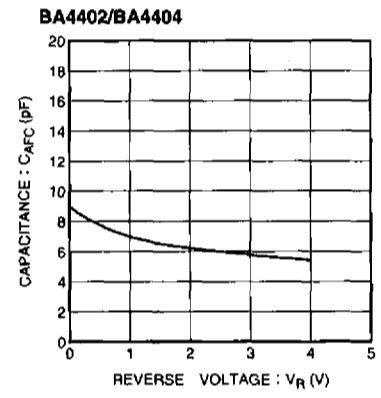

Fig. 15 AFC capacitor capacitance vs. applied voltage

● External dimensions (Unit: mm)

