

# Dual recording/playback preamplifier for radio cassette recorders

## BA3420AL

The BA3420AL is dual recording / playback preamplifier for radio cassette players. It has an internal switch for switching between playback head, mic, and radio input modes, and also includes a bias oscillator and regulated voltage source for radio use.

All control is possible with one external switch, allowing designers to reduce the number of external components and the size of their set designs.

●Applications

Radio cassette players

●Features

- |  |  |
|--|--|
| 1) Internal three-mode input / output switch for playback head, mic and radio modes. | 3) Control of the internal switch and regulated voltage source is possible with one external switch. |
| 2) Built-in bias oscillator and regulated voltage source for radio use.              | 4) Low distortion.   |
|  | 5) Low noise.  |

●Block diagram

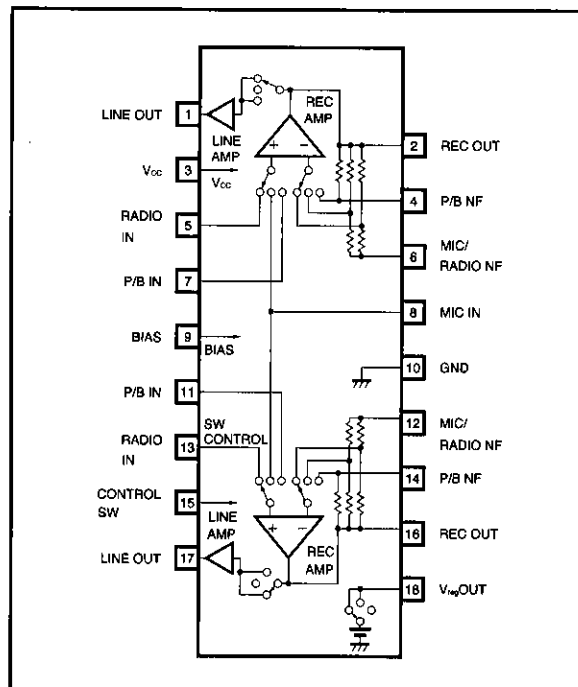

## ● Absolute maximum ratings (Ta = 25°C)

Parameter	Symbol	Limits	Unit
Supply voltage	V <sub>CC</sub>	18	V
Power dissipation	P <sub>d</sub>	400*	mW
Operating temperature	T <sub>opr</sub>	-25~75	°C
Storage temperature	T <sub>stg</sub>	-55~125	°C

\* Reduced by 4.0mW for each increase in Ta of 1°C over 25°C.

## ● Recommended operating conditions (Ta = 25°C)

Parameter	Symbol	Min.	Typ.	Max.	Unit
Supply voltage range	V <sub>CC</sub>	5	—	16	V

●Electrical characteristics (unless otherwise specified Ta = 25°C, V<sub>CC</sub> = 8.0V, f = 1kHz and test circuit : Fig. 1)

Parameter		Symbol	Min.	Typ.	Max.	Unit	Conditions
Quiescent current		I <sub>Q</sub>	—	5.1	9.0	mA	V <sub>IN</sub> =0V <sub>rms</sub> P/B Mode
Voltage gain	P/B Line Amp	G <sub>vc</sub> PL	43.0	45.0	47.0	dB	R <sub>L</sub> =10kΩ, V <sub>O</sub> =0dBm
	Mic Rec Amp	G <sub>vc</sub> MR	49.5	51.5	53.5	dB	R <sub>L</sub> =2kΩ, V <sub>O</sub> =0dBm
	Radio Rec Amp	G <sub>vc</sub> RR	32.0	34.0	36.0	dB	R <sub>L</sub> =2kΩ, V <sub>O</sub> =0dBm
	Radio Line Amp	G <sub>vc</sub> RL	17.5	19.5	21.5	dB	R <sub>L</sub> =10kΩ, V <sub>O</sub> =-15dBm
Maximum output voltage	P/B Line Amp	V <sub>OM</sub> PL	1.2	1.5	—	V <sub>rms</sub>	THD=1%, R <sub>L</sub> =10kΩ
	Mic Rec Amp	V <sub>OM</sub> MR	1.1	1.4	—	V <sub>rms</sub>	THD=1%, R <sub>L</sub> =2kΩ
	Radio Rec Amp	V <sub>OM</sub> RR	1.4	1.7	—	V <sub>rms</sub>	THD=1%, R <sub>L</sub> =2kΩ
	Radio Line Amp	V <sub>OM</sub> RL	0.25	0.3	—	V <sub>rms</sub>	THD=1%, R <sub>L</sub> =10kΩ
Input noise-conversion voltage	P/B Amp	V <sub>NIN</sub> P	—	1.0	2.0	μV <sub>rms</sub>	R <sub>g</sub> =2.2kΩ, V <sub>IN</sub> =0V <sub>rms</sub> , BPF20~20kHz
	Mic Amp	V <sub>NIN</sub> M	—	1.2	2.2	μV <sub>rms</sub>	R <sub>g</sub> =2.2kΩ, V <sub>IN</sub> =0V <sub>rms</sub> , BPF20~20kHz
	Radio Amp	V <sub>NIN</sub> R	—	1.5	3.0	μV <sub>rms</sub>	R <sub>g</sub> =2.2kΩ, V <sub>IN</sub> =0V <sub>rms</sub> , BPF20~20kHz
Total harmonic distortion	P/B Line Amp	THD PL	—	0.05	0.45	%	V <sub>O</sub> =0dBm, R <sub>L</sub> =10kΩ
	Mic Rec Amp	THD MR	—	0.25	1.00	%	V <sub>O</sub> =0dBm, R <sub>L</sub> =2kΩ
	Radio Rec Amp	THD RR	—	0.25	1.00	%	V <sub>O</sub> =0dBm, R <sub>L</sub> =2kΩ
	Radio Line Amp	THD RL	—	0.04	0.45	%	V <sub>O</sub> =-15dBm, R <sub>L</sub> =10kΩ
Interchannel crosstalk level	P/B Line Amp	CT PL	—	—	-50	dBm	P/B <sub>IN</sub> =-45dBm, R <sub>L</sub> =10kΩ
	Radio Rec Amp	CT RR	—	—	-50	dBm	Radio <sub>IN</sub> =-34dBm, R <sub>L</sub> =2kΩ
	Radio Line Amp	CT RL	—	—	-50	dBm	Radio <sub>IN</sub> =-34dBm, R <sub>L</sub> =10kΩ
Inter-mode crosstalk	1	CT 1	—	-62	-49	dBm	P/B <sub>IN</sub> =-45dBm, Mic Mode RecOut
	2	CT 2	—	-110	-80	dBm	P/B <sub>IN</sub> =-45dBm, Mic Mode LineOut
	3	CT 3	—	-72	-59	dBm	P/B <sub>IN</sub> =-45dBm, Radio Mode RecOut
	4	CT 4	—	-92	-79	dBm	P/B <sub>IN</sub> =-45dBm, Radio Mode LineOut
	5	CT 5	—	-72	-59	dBm	Mic <sub>IN</sub> =-51.5dBm, P/B Mode LineOut
	6	CT 6	—	-76	-63	dBm	Mic <sub>IN</sub> =-51.5dBm, Radio Mode RecOut
	7	CT 7	—	-92	-79	dBm	Mic <sub>IN</sub> =-51.5dBm, Radio Mode LineOut
	8	CT 8	—	-72	-59	dBm	Radio <sub>IN</sub> =-34dBm, P/B Mode LineOut
	9	CT 9	—	-62	-48	dBm	Radio <sub>IN</sub> =-34dBm, Mic Mode RecOut
	10	CT 10	—	-107	-80	dBm	Radio <sub>IN</sub> =-34dBm, Mic Mode LineOut
Mic amplifier mute level		Mute	—	—	-80	dBm	Mic <sub>IN</sub> =-51.5dBm, Mic Mode LineOut
Input resistance	P/B Amp	R <sub>IN</sub> P	27	35	43	kΩ	V <sub>IN</sub> =5mV <sub>rms</sub>
	Mic Amp	R <sub>IN</sub> M	14	18	22	kΩ	V <sub>IN</sub> =1.7mV <sub>rms</sub>
	Radio Amp	R <sub>IN</sub> R	27	35	43	kΩ	V <sub>IN</sub> =17mV <sub>rms</sub>
Regulated voltage source output voltage		V <sub>regout</sub>	4.3	4.75	5.2	V	R <sub>L</sub> =50kΩ, Mic Mode
Regulated voltage source output current		I <sub>out</sub>	115	180	—	μA	R <sub>L</sub> =25kΩ, Mic Mode
Regulated voltage source temperature characteristic		ΔV <sub>reg</sub> /ΔT	—	-5.4	—	mV/°C	R <sub>L</sub> =50kΩ, Mic Mode

● Measurement circuit

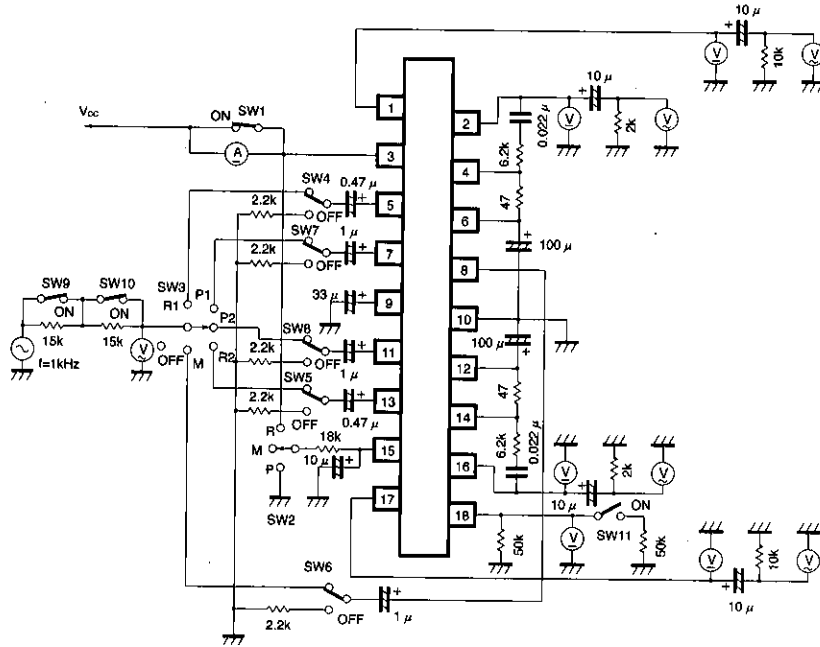

Fig. 1

● Measurement circuit switch control table

Item	Symbol	Condition	SW 1	SW 2	SW 3	SW 4	SW 5	SW 6	SW 7	SW 8	SW 9	SW 10	SW 11
Quiescent current	$I_o$	P/B Mode	OFF	P	OFF	OFF	OFF	OFF	OFF	OFF	ON	ON	OFF
Voltage gain	$G_{vcPL}$	P/B Line Amp	ON	P	P1/P2	OFF	OFF	OFF	ON/OFF	OFF/ON	ON	ON	OFF
	$G_{vcMR}$	Mic Rec Amp	ON	M	M	OFF	OFF	ON	OFF	OFF	ON	ON	OFF
	$G_{vcRR}$	Radio Rec Amp	ON	R	R1/R2	ON/OFF	OFF/ON	OFF	OFF	OFF	ON	ON	OFF
	$G_{vcRL}$	Radio Line Amp	ON	R	R1/R2	ON/OFF	OFF/ON	OFF	OFF	OFF	ON	ON	OFF
Maximum output voltage	$V_{omPL}$	P/B Line Amp	ON	P	P1/P2	OFF	OFF	OFF	ON/OFF	OFF/ON	ON	ON	OFF
	$V_{omMR}$	Mic Rec Amp	ON	M	M	OFF	OFF	ON	OFF	OFF	ON	ON	OFF
	$V_{omRR}$	Radio Rec Amp	ON	R	R1/R2	ON/OFF	OFF/ON	OFF	OFF	OFF	ON	ON	OFF
	$V_{omRL}$	Radio Line Amp	ON	R	R1/R2	ON/OFF	OFF/ON	OFF	OFF	OFF	ON	ON	OFF
Input noise-conversion voltage	$V_{nINP}$	P/B Amp	ON	P	OFF	OFF	OFF	OFF	OFF	OFF	ON	ON	OFF
	$V_{nINM}$	Mic Amp	ON	M	OFF	OFF	OFF	OFF	OFF	OFF	ON	ON	OFF
	$V_{nINR}$	Radio Amp	ON	R	OFF	OFF	OFF	OFF	OFF	OFF	ON	ON	OFF
Total harmonic distortion	THD PL	P/B Line Amp	ON	P	P1/P2	OFF	OFF	OFF	ON/OFF	OFF/ON	ON	ON	OFF
	THD MR	Mic Rec Amp	ON	M	M	OFF	OFF	ON	OFF	OFF	ON	ON	OFF
	THD RR	Radio Rec Amp	ON	R	R1/R2	ON/OFF	OFF/ON	OFF	OFF	OFF	ON	ON	OFF
	THD RL	Radio Line Amp	ON	R	R1/R2	ON/OFF	OFF/ON	OFF	OFF	OFF	ON	ON	OFF

Preamplifiers  
Low-frequency amplifiers

Item	Symbol	Condition	SW 1	SW 2	SW 3	SW 4	SW 5	SW 6	SW 7	SW 8	SW 9	SW 10	SW 11	
Interchannel crosstalk level	CT PL	P/B LineAmp	1ch→2ch	ON	P	P1	OFF	OFF	OFF	ON	OFF	ON	ON	OFF
			2ch→1ch	ON	P	P2	OFF	OFF	OFF	OFF	ON	ON	ON	OFF
	CT RR	Radio RecAmp	1ch→2ch	ON	R	R1	ON	OFF	OFF	OFF	OFF	ON	ON	OFF
			2ch→1ch	ON	R	R2	OFF	ON	OFF	OFF	OFF	ON	ON	OFF
	CT RL	Radio LineAmp	1ch→2ch	ON	R	R1	ON	OFF	OFF	OFF	OFF	ON	ON	OFF
			2ch→1ch	ON	R	R2	OFF	ON	OFF	OFF	OFF	ON	ON	OFF
Inter-mode crosstalk level	CT 1	P/B→Mic RecOut		ON	M	P1/P2	OFF	OFF	OFF	ON/OFF	OFF/ON	ON	ON	OFF
	CT 2	P/B→Mic LineOut		ON	M	P1/P2	OFF	OFF	OFF	ON/OFF	OFF/ON	ON	ON	OFF
	CT 3	P/B→Radio RecOut		ON	R	P1/P2	OFF	OFF	OFF	ON/OFF	OFF/ON	ON	ON	OFF
	CT 4	P/B→Radio LineOut		ON	R	P1/P2	OFF	OFF	OFF	ON/OFF	OFF/ON	ON	ON	OFF
	CT 5	Mic→P/B LineOut		ON	P	M	OFF	OFF	ON	OFF	OFF	ON	ON	OFF
	CT 6	Mic→Radio RecOut		ON	R	M	OFF	OFF	ON	OFF	OFF	ON	ON	OFF
	CT 7	Mic→Radio LineOut		ON	R	M	OFF	OFF	ON	OFF	OFF	ON	ON	OFF
	CT 8	Radio→P/B LineOut		ON	P	R1/R2	ON/OFF	OFF/ON	OFF	OFF	OFF	ON	ON	OFF
	CT 9	Radio→Mic RecOut		ON	M	R1/R2	ON/OFF	OFF/ON	OFF	OFF	OFF	ON	ON	OFF
	CT 10	Radio→Mic LineOut		ON	M	R1/R2	ON/OFF	OFF/ON	OFF	OFF	OFF	ON	ON	OFF
Mic Amplifier mute level	Mute	Mic LineAmp		ON	M	M	OFF	OFF	ON	OFF	OFF	ON	ON	OFF
Input resistance	R <sub>INP</sub>	P/B Amp		ON	P	P1/P2	OFF	OFF	OFF	ON/OFF	OFF/ON	OFF	OFF	OFF
	R <sub>INM</sub>	Mic Amp		ON	M	M	OFF	OFF	ON	OFF	OFF	OFF	ON	OFF
	R <sub>INR</sub>	Radio Amp		ON	R	R1/R2	ON/OFF	OFF/ON	OFF	OFF	OFF	OFF	OFF	OFF
Regulated voltage source output voltage	V <sub>reg Out</sub>	Mic Mode		ON	M	OFF	OFF	OFF	OFF	OFF	OFF	ON	ON	OFF
Regulated voltage source output current	I <sub>out</sub>	Mic Mode		ON	M	OFF	OFF	OFF	OFF	OFF	OFF	ON	ON	ON

● Application example 1

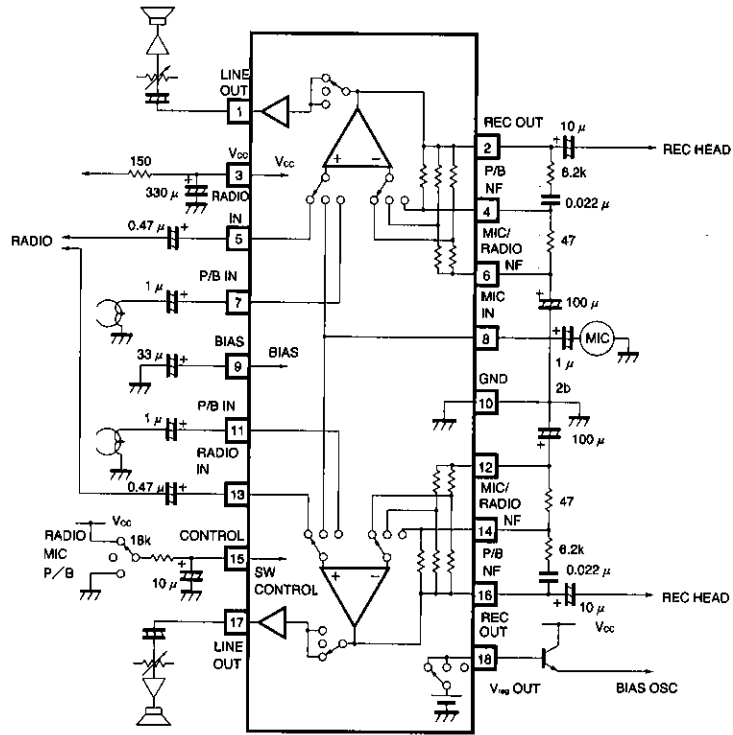

Fig. 2

● Application example block diagram

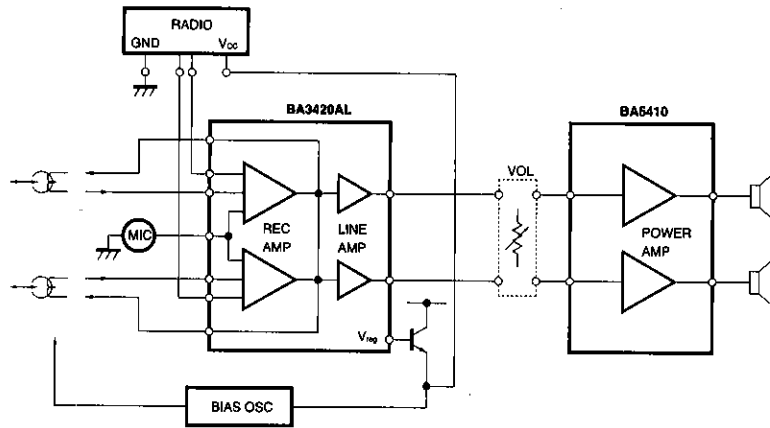

Fig. 3

Preamplifiers

Low-frequency amplifiers

● Application example 2

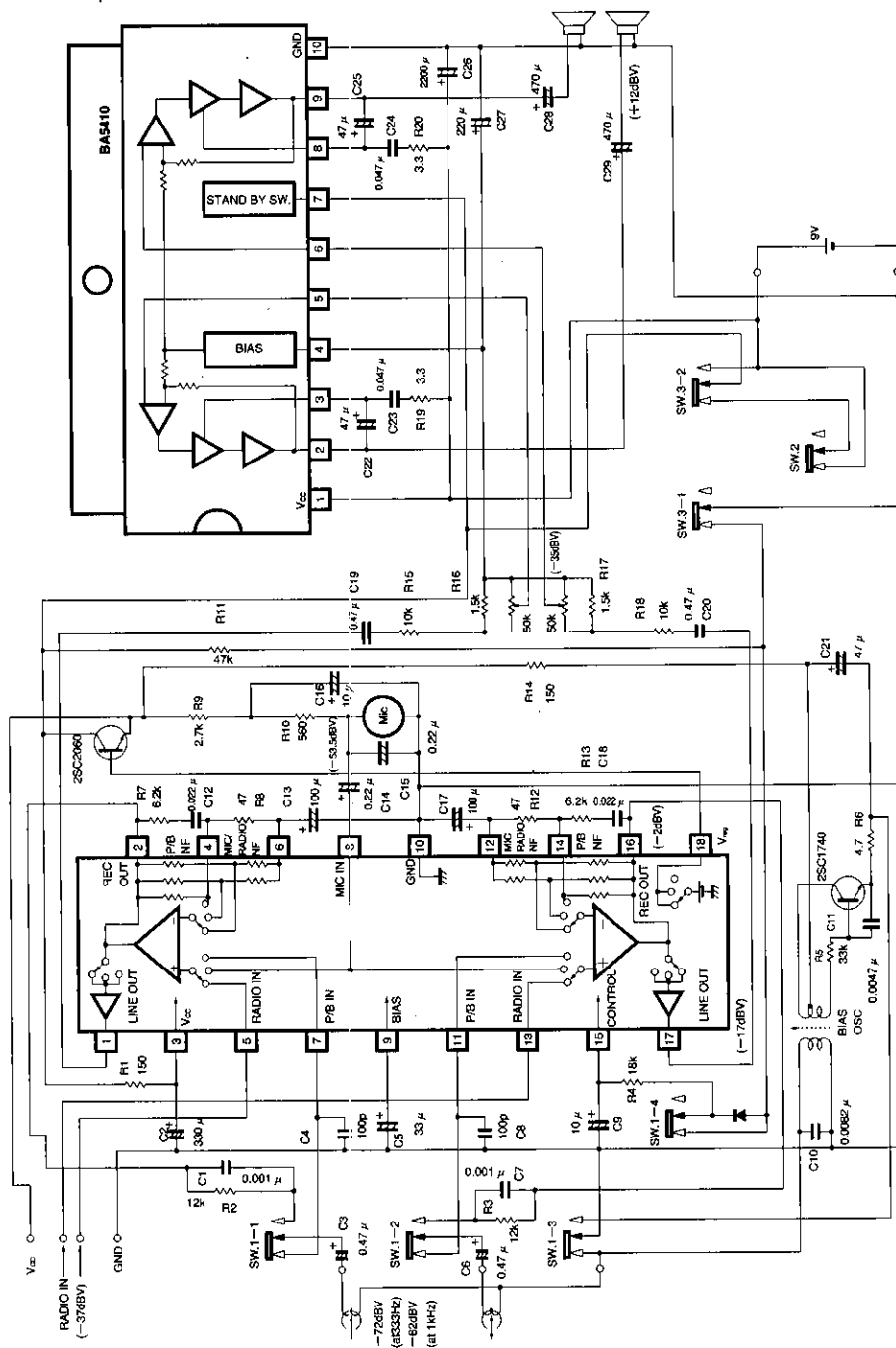

Fig. 4

Note: The power amplifier used in this circuit example is the BA5410.  
 This component is no longer sold. Use this circuit diagram for reference only.

●Electrical characteristics curves

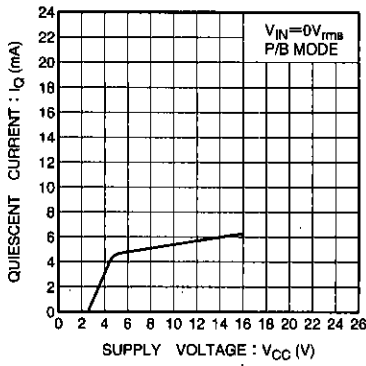

Fig. 5 Quiescent current vs. supply voltage

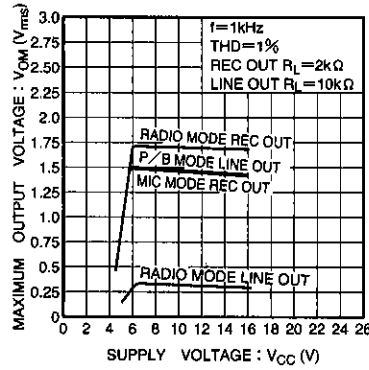

Fig. 6 Maximum output voltage vs. supply voltage

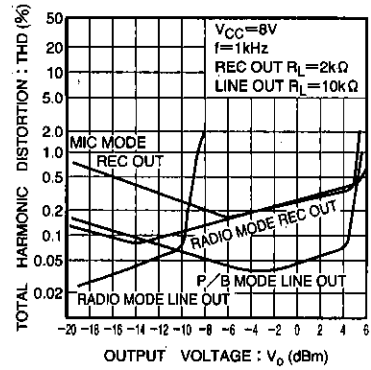

Fig. 7 Total harmonic distortion vs. output voltage

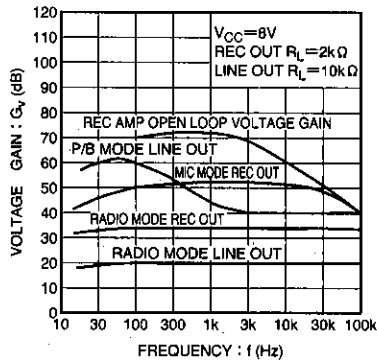

Fig. 8 Voltage gain vs. ambient temperature

●External dimensions (Unit: mm)

