

Dual preamplifier with ALC

BA3306

The BA3306 is a dual preamplifier with ALC designed for use in stereo radio-cassette recorders and tape recorders. It comes in a compact 9-pin SIP package and has two record/playback preamplifiers, and an ALC circuit. The preamplifiers have high gain and low distortion, and can be directly coupled to the tape head without coupling capacitors. This prevents tape head magnetization and "pop" noise generation.

The ALC circuit has good channel balance and large dynamic range and can be constructed with addition of just an external detector and time constant circuit.

The IC also includes a power-on mute circuit that suppresses "pop" noise generation.

● Applications

Stereo radio cassette players

● Features

- 1) Wide operation supply voltage range ($V_{CC} = 4.5V$ to $14V$).
- 2) Low current consumption ($I_a = 2.5mA$).
- 3) High gain ($G_{vo} = 80dB$).
- 4) Low distortion (THD = 0.1%).
- 5) Low noise ($V_{MIN} = 1 \mu V_{rms}$).
- 6) Input coupling capacitors and not necessary.
- 7) Good ALC channel balance.
- 8) Power-on mute circuit.

● Block diagram

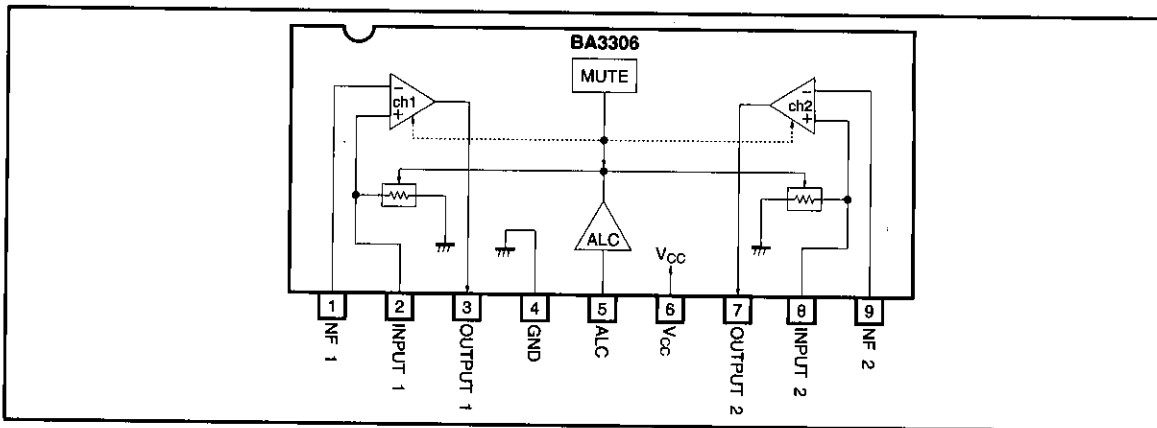

● Absolute maximum ratings ($T_a = 25^\circ C$)

Parameter	Symbol	Limits	Unit
Supply voltage	V_{CC}	16	V
Power dissipation	P_d	950*	mW
Operating temperature	T_{opr}	$-25 \sim 75$	$^\circ C$
Storage temperature	T_{stg}	$-55 \sim 125$	$^\circ C$

* Reduced by 9.5mW for each increase in T_a of $1^\circ C$ over $25^\circ C$.

● Recommended operating conditions (Ta = 25°C)

Parameter	Symbol	Min.	Typ.	Max.	Unit
Supply voltage	V _{CC}	4.5	7	14	V

● Electrical characteristics (unless otherwise specified Ta = 25°C, V_{CC} = 7V, and f = 1kHz)

Parameter	Symbol	Min.	Typ.	Max.	Unit	Conditions	Measurement Circuit
Quiescent circuit current	I _Q	1.5	2.5	4.0	mA	V _{IN} =0V _{rms}	Fig.1
Open-circuit voltage gain	G _{VO}	70	80	—	dB	V _{OUT} =-10dBV	Fig.1
Total harmonic distortion	THD	—	0.1	0.3	%	NAB 34dB, V _{OUT} =40mV _{rms}	Fig.1
Input resistance	R _{IN}	15	25	45	kΩ	—	Fig.1
Maximum output voltage	V _{OM}	0.6	1.2	—	V _{rms}	THD=1%	Fig.1
Input conversion-noise voltage	V _{NIN}	—	1.0	2.0	μV _{rms}	R _g =2.2kΩ, BPF=20Hz~20kHz	Fig.1
ALC Channel balance	ΔALC	—	0	2.5	dB	V _{IN} =-60dBV, -30dBV	Fig.1

● Measurement circuit

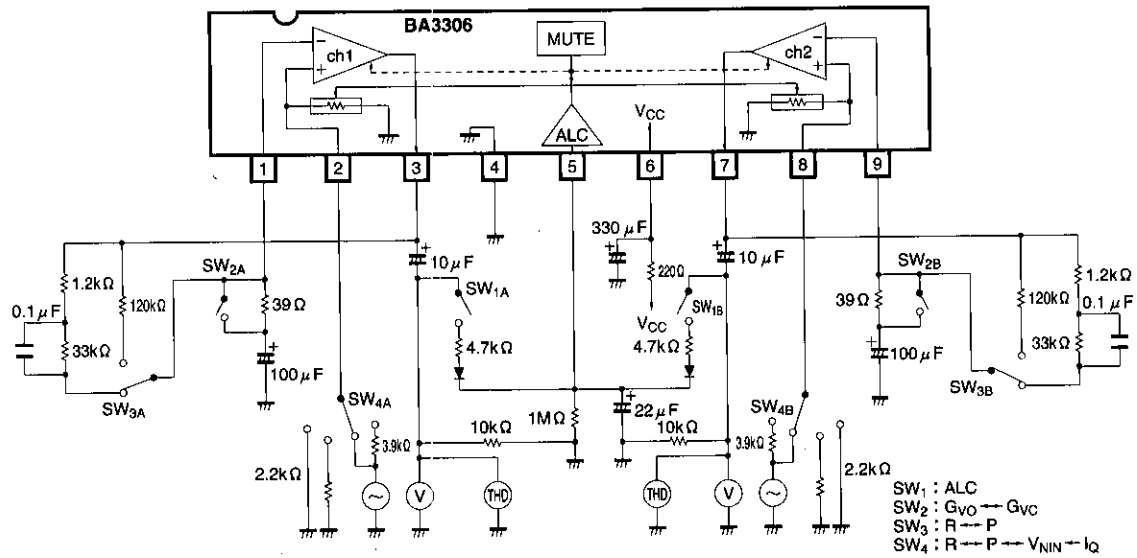

Fig. 1

● Application example

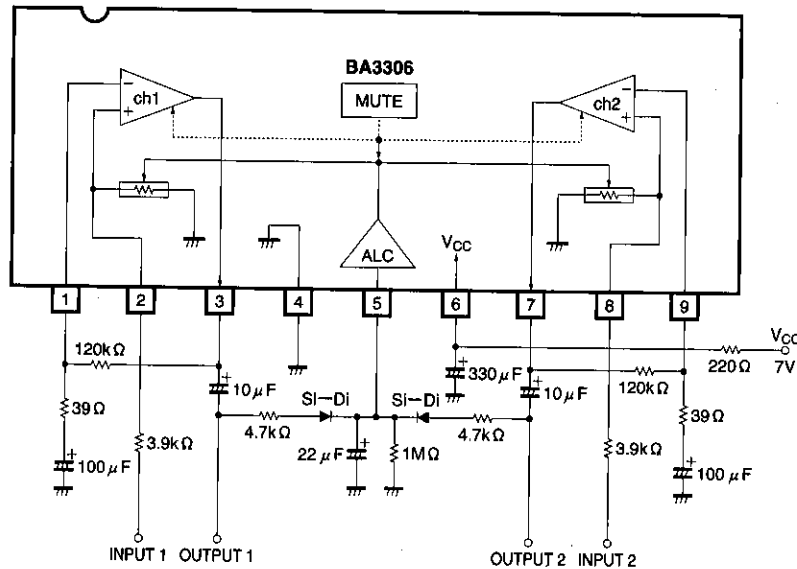

Fig. 2

● Circuit operation

(1) Recording (See Fig. 3)

For recording, insert an attenuation resistor (3.9kΩ recommended) into the input line.

The ALC timing is determined by the time constant of the circuit connected between pin 5 and GND. The attack time is set the capacitor (22 μF) and the resistor (4.7kΩ) that is connected in series with the diode. The recovery time is set by this capacitor and the resistor (1MΩ) connected to pin 5.

(2) Playback (See Fig. 4)

For playback, the amplifier is used as a NAB equalizer amplifier. The ALC circuit is not needed at this time, so pin 5 is earthed. The negative feedback time constant settings are Hi - 120 μs and Lo - 3180 μs.

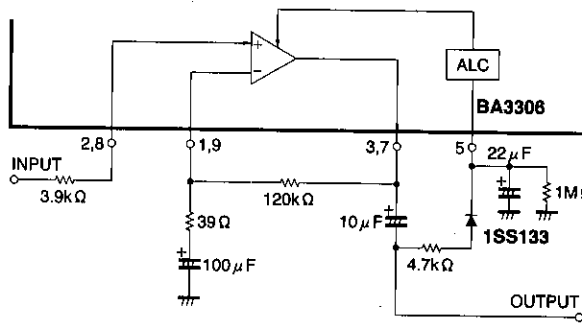

Fig. 3

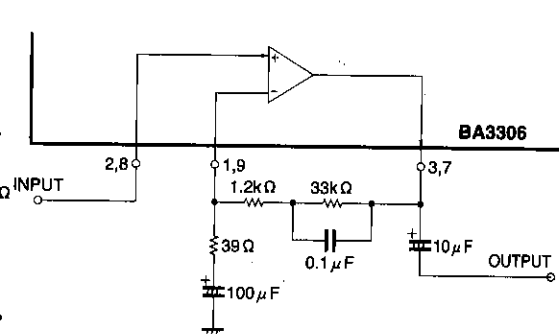

Fig. 4

Preamplifiers

Low-frequency amplifiers

● Electrical characteristics curves

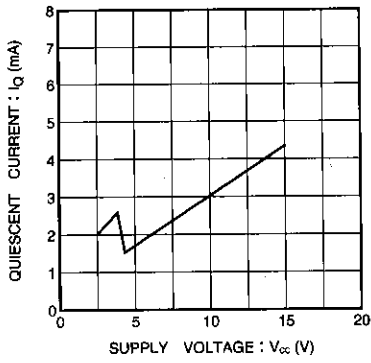

Fig. 5 Quiescent current vs. supply voltage

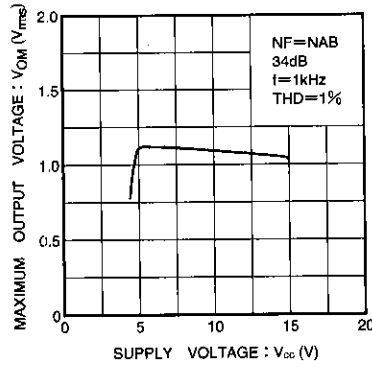

Fig. 6 Maximum output voltage vs. supply voltage

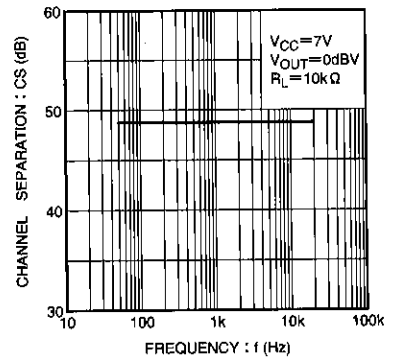

Fig. 7 Channel separation vs. signal frequency

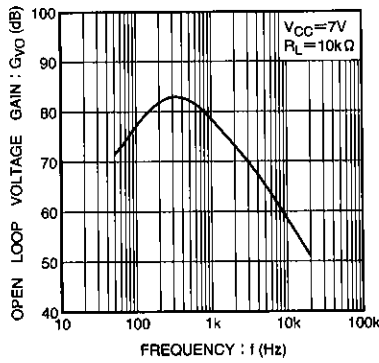

Fig. 8 Open circuit voltage gain vs. signal frequency

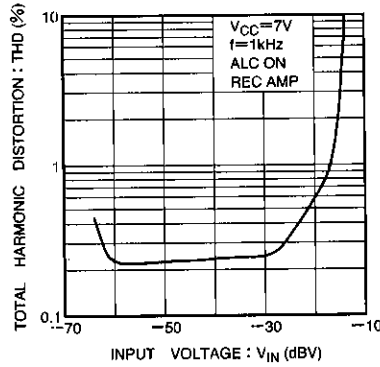

Fig. 9 Total harmonic distortion vs. input voltage

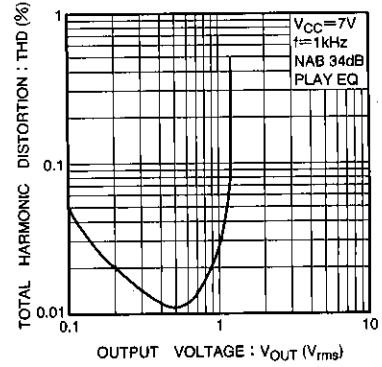

Fig. 10 Total harmonic distortion vs. output voltage

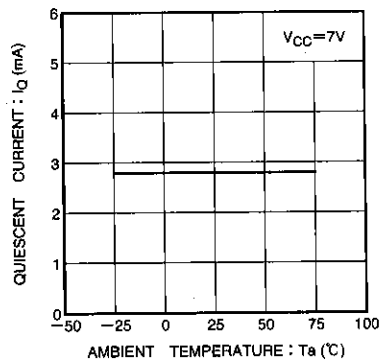

Fig. 11 Quiescent current vs. ambient temperature

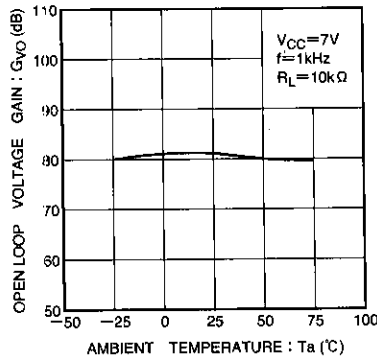

Fig. 12 Open circuit voltage gain vs. ambient temperature

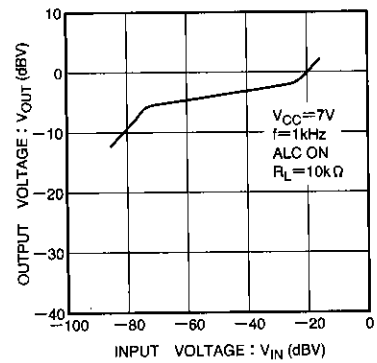
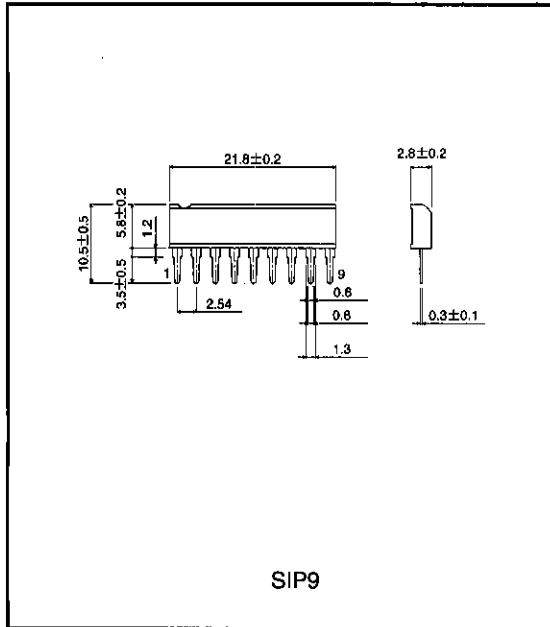

Fig. 13 ALC I/O characteristics

● External dimensions (Unit: mm)



Preamplifiers

Low-frequency amplifiers